

ARX
SPIN



Made in Europe

ARX
by KOVINOPLASTIKA LOŽ

10-YEAR
WARRANTY

Made in Europe

ARX
by KOVINOPLASTIKA LOŽ

ARX COAT
SURFACE
PROTECTION

ARX SPIN PVC

High quality, durable and simple
Turn & Tilt hardware for PVC windows

KOVINOPLASTIKA LOŽ
— Since 1954 —

2024

Made in Europe
ARX
by KOVINOPLASTIKA LOŽ
10-YEAR
WARRANTY

Made in Europe
ARX
by KOVINOPLASTIKA LOŽ
ARX COAT
SURFACE
PROTECTION

Bring premium quality
into your home for a lifetime.

ARX PORTFOLIO



IFT Rosenheim
-Certificate of conformity
for ARX SPIN and ARX
DOOR LOCK.

ARX SPIN



Turn and tilt hardware solutions
for windows and balcony doors.



ARX DOOR LOCK



Multipoint door lock solutions for
main and back entrance doors.



ARX CASEMENT



Solutions for
casement windows
-outward opening.



ARX SLIDE



Sliding hardware
solutions for doors
and windows.



ARX ACCESSORIES



High quality, durable
and simple accessories
for windows and doors.



Follow us:



www.arx-hardware.com



ARX – bring premium quality in your home for a lifetime

ARX is one of the leading providers of window and door hardware In Europe. Brand ARX is built on more than 70 years of foundation and experience of KOVINOPLASTIKA LOŽ. From that knowledge we are drawing the inspiration to create new and innovative solutions. Integrity in everything we do, quality of our work, and tailor-made building hardware solutions for our customers are the secret of our success and harmonious partnership with our customers. .

Window and door hardware tailored to your demands

Concerning costumers our goal is to provide functional, reliable & innovative experience of uncompromising quality that meets the highest standards of window and door hardware. We are focused on developing and applying best solutions in the field, while guaranteeing a flexible and efficient production process. Such approaches, in combination with the established knowledge, enable our experts to design and execute the most appropriate solutions tailored to your demands.

Our values, vision and mission

We are a team of engaged co-workers with the highest values like honesty, excellence, openness, endeavor and responsibility. We always strive to optimally use the knowledge and technologies, by which we develop and create the products and assemblies with higher added value, to ensure end users with a high level of security, wellbeing and best user experience. Our efforts have been rewarded by becoming established well-known development supplier. Being the best flexible and digitized niche solution developer and material modifier is our first and foremost mission.

CONTENTS

ABOUT	1
WHY ARX	6
BETTER THAN THE REST	7
STANDARDS AND CERTIFICATES	9
PRODUCT WARRANTY AND LIABILITY	10
HIGH-QUALITY, DURABLE, SIMPLE	12
SYMBOLS LEGEND	14
REGULATION OF PRODUCT WARRANTY	15
PROFILE RECOMMENDATION	16
TYPICAL HARDWARE SCHEMES	17
T&Ti face-fit hinge side	18
Fixed handle height	18
Centered / variable handle height.	20
T&T face-fit hinge side	22
Fixed handle height	22
Centered / variable handle height.	24
T&Ti RC 1 face-fit hinge side	26
Fixed handle height	26
Centered / variable handle height.	28
T&Ti RC 2 face-fit hinge side	30
Fixed handle height	30
Centered / variable handle height.	32
T&Ti concealed hinge side	34
Fixed handle height	34
Centered / variable handle height.	36
T&T concealed hinge side	38
Fixed handle height	38
Centered / variable handle height.	40
TURN - basic face-fit hinge side	42
Fixed handle height	42
TURN - standard face-fit hinge side	44
Fixed handle height	44
TURN - basic face-fit hinge side	46
Centered / variable handle height.	46
TURN - standard face-fit hinge side	48
Centered / variable handle height.	48
TURN - basic concealed hinge side	50
Fixed handle height	50
TURN - standard concealed hinge side	52
Fixed handle height	52
TURN - basic concealed hinge side	54
Centered / variable handle height.	54
TURN - standard concealed hinge side	56
Centered / variable handle height.	56
TILT - basic face-fit hinge side	58
Centered / variable handle height.	58
TILT - standard face-fit hinge side	60
Centered / variable handle height.	60

CONTENTS

TILT - basic concealed hinge side	62
Centered / variable handle height	62
TILT - standard concealed hinge side	64
Centered / variable handle height	64
TURN - Second sash face-fit hinge side	66
Fixed handle height First sash T&Ti	66
Centered / variable handle height First sash T&Ti	68
Fixed handle height First sash T&T	70
Centered / variable handle height First sash T&T	72
Shootbolts	74
TURN - Second sash - RC 1 security face-fit hinge side	76
Fixed handle height First sash T&Ti	76
Centered / variable handle height First sash T&Ti	78
TURN - Second sash concealed hinge side	80
Fixed handle height First sash T&Ti	80
Centered / variable handle height First sash T&Ti	82
Fixed handle height First sash T&T	84
Centered / variable handle height First sash T&T	86
Shootbolts	88
T&Ti - ARCHED WINDOW face-fit hinge side	90
Fixed handle height	90
Centered / variable handle height	92
T&Ti - PITCHED WINDOW face-fit hinge side	94
Fixed handle height	94
Centered / variable handle height	96

PRODUCT PORTFOLIO99

T&T ESPAGNOLETTE M	100
T&T ESPAGNOLETTE M - larger backsets	101
T&T ESPAGNOLETTE M - larger backsets + lockable	102
ESPAGNOLETTE M	103
T&T ESPAGNOLETTE KV	104
ESPAGNOLETTE	106
T&T ESPAGNOLETTE	107
REVERSE ACTION ESPAGNOLETTE	109
FRENCH WINDOW ESPAGNOLETTE M	110
FRENCH WINDOW ESPAGNOLETTE KV	111
CORNER DRIVE	112
SASH-STAY GUIDE	114
Turn & tilt	114
Turn only - SECOND SASH	114
Sash stay guide - additional security	115
STAY ARM	116
Stay arm	116
Stay arm - additional security	117
Rebate stay arm	118
Rebate stay arm - ALU	118
Tilt stay	119
Stay arm & lifter for arched / pitched window	119
CENTER LOCK	120
With guide	120

CONTENTS

Without guide	120
CENTER LOCK - arched / pitched window	121
Vertical	121
Horizontal	121
Arched	122
ESPAGNOLETTE EXTENSION	123
Primary window	123
French window	123
Lock bolt	124
French window lock bolt	124
SHOOTBOLT - OHG	125
CONCEALED HINGE SIDE	126
Affiliation by profiles	126
Sash stay guide	127
Hinge side - UP	128
Rebate stay arm	129
Rebate stay arm guide	129
Hinge side - DOWN	130
Hinge side - PACKERS	131
FACE-FIT HINGE SIDE	132
Hinge side - UP	132
Hinge side - BOTTOM / SIDE	132
Hinge side - DOWN	133
COVER CAPS	134
T&T STRIKER	136
T&Ti STRIKER	137
T&Ti STRIKER - tilt first	138
STRIKER	139
SECURITY striker	140
MISHANDLING DEVICE	141
STRIKER - second sash	142
NIGHT VENT STRIKER - R or RS CAM	143
NIGHT VENT STRIKER - CORNER DRIVE NV	144
CENTER STRIKER CLOSER	145
BULLET CATCH	146

INSTALLATION INSTRUCTIONS.....149

SASH PROFILE TREATMENT	150
Window-handle drilling	150
Gear-case routing	150
Lock-case drilling	151
Corner hinge K3	152
Corner hinge K6	152
FRAME PROFILE TREATMENT	153
Sash stay bearing K3	153
Sash stay bearing K6	153
Corner pivot rest K3	154
Corner pivot rest K6	154
INSTALLATION INSTRUCTIONS	155
Pitched window - upper hinge	155
Arched window - upper hinge	156

CONTENTS

Arched larger window - upper hinge	157
Pitched / arched window - sash lifter	158
Sash stay guide and center lock assembly	159
Tilt lock bolt and center lock assembly	159
T&T system with T&T espagnolette.....	160
T&Ti system with T&T M espagnolette	160
Slider.....	161
Anti slam device - tilt reduction	161
CONCEALED HINGE SIDE INSTALLATION INSTRUCTIONS	162
Tilt & turn / Turn only	162
Stay arm and corner pivot - frame mounting.....	162
Corner pivot and corner hinge - frame mounting.....	162
Stay arm and sash stay guide	163
Turn limiter and turn limiter holder	163
Tilt only.....	164
Rebate stay arm - frame mounting.....	164
Rebate stay arm and rebate stay arm guide.....	165
Rebate stay arm orientation.....	165
STRIKER JIGS INSTALLATION INSTRUCTIONS	166
Types	166
Instructions for use.....	167
HARDWARE ADJUSTMENT INSTRUCTIONS	168
Face-fit hinge side	168
Concealed hinge side.....	169
LOCKING CAM ADJUSTMENT INSTRUCTIONS	170
MAINTENANCE RECOMMENDATIONS	171
OPERATING AND SYSTEM INSTRUCTIONS	172
Operation of window.....	172
OPERATING AND SYSTEM INSTRUCTIONS	173
Warning!.....	173
ARX HANDLES	175
HANDLES	176
Certificate of Quality	176
Window handles.....	177
Balcony door handles.....	178
Balcony door handles - basic.....	179
Rosette.....	179
NOTES	180



Quality-to-price ratio that ensures for the best market performance

Besides its distinctive quality, the ARX building hardware has an excellent quality-to-price ratio, providing you with a fast and effective strategy of winning market positions both in the Europe and globally. We provide the best quality, value, and service to meet our business partners' and users' needs, never leaving them in the lurch.

Accelerating the pace of innovation

Through the years we were never the silent observers of migration from old window and door hardware solutions to the nowadays highly technological ones, tailored for smart homes and buildings. Experiences, engineering knowledge and valuable partnerships helped us respond to and anticipate market needs, adapt our methods or materials, and innovate. Development of high-quality new products that have left a mark on the industry and decades of experience have shaped our unique path.



There is hardware,
and then there is **ARX**.

FOR FULL TERMS
AND CONDITIONS,
PLEASE VISIT:





Based on the huge versatility of our knowledge implemented into the design and applied research, we do not simply offer you products; we provide you with the following BENEFITS:



ARX 10-year warranty

For you to have complete confidence in our products, proven technologies, and expert skills, like we do, we provide you with a 10-year warranty on our building hardware functionality. The warranty applies exclusively to the use of the ARX building hardware, and to all manufacturers and suppliers of doors and windows who use ARX building hardware.



ARX surface protection and resistance coating ARX

Surface protection and resistance coating ARX Coat, provided by Kovino-plastika Lož is one of the best on the market.

Testing of corrosion resistant coating is carried out in our salt chamber according to standard ISO 9227 (NSS). It is done periodically, so we control the whole process. In case of deviations from perfect surface protection, immediate actions are applied to the manufacturing process to produce only the best products.

ARX building hardware suits the highest requirements of corrosion resistance as it reaches the 5th grade according to the standard EN 1670. That is an equivalent of 480 hours of salt spray.

ARX Coat is a proper surface protection, which provides good anti-corrosion durability and a trendy silver appearance, all due to our ARX internal processes.



Versatile hardware

ARX SPIN hardware can be used for PVC & timber windows and ALU windows with Euro-groove 16 mm. Many top design features offer a reliable operation, security, and functionality.

The main features of ARX SPIN hardware are:

- Best solutions for PVC & timber windows and ALU windows with Eurogroove 16 mm.
- High quality and smooth operation after years of use thanks to the ROLLING CAMS and the reduced contact area between the parts of hardware where sliding contact occurs.
- ARX SPIN for simple, fast and efficient installation with SNAP FUNCTION Slider & Straight cut.
- Wide range of applications and the possibility of combination with other product groups.
- High quality production and installation of individual hardware sets by using highly automated production.
- Easy adjustment for different window dimensions, shapes, and constructions.
- ARX SPIN for PVC profiles achieves the highest level of H3 according to the certification scheme QM328.
- ARX SPIN for TIMBER profiles achieves the level of H2 according to the certification scheme QM328.
- Guarantee of the Lifetime Warranty for functionality.
- Providing the 10-year warranty for the ARX Coat the highest corrosion protection Grade 5 according to EN1670 (480 hours exposure to salt spray).
- Possibility of R CAMS & RS cams:
 - a) R cams incorporate a regulatory function which allows installer or user to optimize the window compression by +/- 1.2 mm (hex key size 4), thereby improving the sealing properties of windows and balcony doors. Moreover, the R cams provide smoother operation to window users who only need to apply a minimum force to operate the handle.
 - b) RS cams provide superior level of security at closing points (with security strikers). Their height adjusts automatically to fit the air gap between sash and frame. The compression can be regulated by +/- 0.8 mm (hex key size 2.5 or spanner 10). The rolling cam enables smoother and easier closing operation. RS cams can be used in combination with both security strikers and standard strikers.



Manufacturer's standards and certificates

Our certificates present our dedication to the verifiable quality standards for processes and products. We are proud that we have repeatedly earned them. In every certificate, we see undisputed proof of long-term commitment to our partners, employees, and leadership.

MANAGEMENT SYSTEM CERTIFICATES:

- ISO 9001
- ISO 14001

CERTIFICATE OF CONFORMITY:

- IFT (QM 328)
- IFT (QM 342)

Kovinoplastika Lož acquired many important standards and certificates. Among them is EN1670 (grade 5) which has been held without interruption.



1. Introduction

According to the instructions of the Quality Association for Locks and Hardware (Gütegemeinschaft Schlösser und Beschläge), the VHBH Directive, issued on 11.12.2009 and the manufacturer's responsibility for its products, defined in the Consumer Protection Act (Consumer Protection Act of the Republic of Slovenia, paragraph 2, §4-11a), the following information about the turn-only and tilt&turn hardware for sashes must be observed. Failure to comply with the following information exempts the manufacturer from liability.

2. Product information and stipulated application

2.1 Quality Assurance Association for Locks and Hardware

(Gütegemeinschaft Schlösser und Beschläge) published in the VHBH Directive states that turn-only and tilt-and-turn hardware is hardware for turnable and tiltable sashes for windows in building construction.

- This hardware is used for: bringing windows and sashes of windows, by activation of a handle, into a turning position,
- bringing windows and sashes of windows into a tilting position restricted by means of a scissor stay version.

Turn-only and turn&tilt hardware is used for installation in windows and balcony doors which are to be vertically installed, made from timber, PVC, aluminium or steel, and their corresponding combination.

According to the definition above, the regular function of the turn-only and turn & tilt hardware is closing the windows and sashes and opening them in different airing positions. When the sash is closed, the resistance of a gasket normally needs to be overcome.

2.2 Misuse – exclusion of liability

Misuse is not compliant with the basic purpose of hardware. Anti-theft windows and balcony doors for wet spaces and installation in aggressive and corrosive climate require special hardware with particularly defined characteristics, adjusted to individual building case.

2.3 Restrictions on the use

Open windows, sashes and balcony doors only have protective function and do not provide window fissure sealing, safety in heavy rain or snow, sound and thermal insulation and anti-theft protection. In windy weather and in case of draught, windows and sashes must be closed and bolted. Windy weather and draught logically mean that a window, a sash or balcony doors open and close automatically and uncontrollably in one of the open positions due to air pressure or whirlwind. The only way to make a window, sash or balcony doors fixedly open, is to install additional hardware elements.

2.4 Use in case of special requirements

Wind resistance of the closed and bolted window depends on the actual structure of window and balcony doors. In case a window (or a sash or balcony door) has to endure wind load, according to the DIN EN 12210 standards (in particular pressure test p3), suitable hardware compilations are to be

matched in relation to the respective window design and frame material, and each case individually agreed upon.

Anti-theft windows and balcony doors for wet spaces and installation in aggressive and corrosive climate require special hardware with particularly defined characteristics, adjusted to individual building case.

In general, the turn-only, turn & tilt and tilt & slide hardware meet the requirements according to the DIN 18025 standards, applicable to open-type buildings. To this end, particular agreements and adjustments regarding the appropriate hardware structure and its installation on windows and balcony doors are required.

3. Misuse of the product

Misuse of the turn & tilt and slide hardware for window and balcony doors (i.e. the use, non-compliant with intended use of the product) includes the following:

- inserting obstacles in the opening vicinity between the frame and sash and thus preventing the proper specified use,
- if, contrary to the instructions of use, the window or the sash is uncontrollably pushed toward the window reveals (e.g. because of the wind), causing damage or destruction of hardware, sash material or other parts of the window and the sash,
- additional load on the windows or balcony door sashes (if, for example, children swing on the windows or balcony door sashes),
- inserting a hand or an object into the rebate between the window and the sash when closing the window or balcony doors (risk of injury).

4. Product warranty

The manufacturer of ARX building hardware provides a 10-year warranty on functionality and on surface protection, starting from the date of delivery of goods that is defined or can be defined and applies to the territory of the EU.

The warranty applies exclusively to the use of ARX building hardware components. In case of combining ARX building hardware components with components of other manufacturers, this warranty is void. The warranty applies to all manufacturers and suppliers of doors and windows who use ARX building hardware, starting from the purchasing date that is written on the invoice.

For more information please check warranty conditions on webpage - www.arx-hardware.com.

5. Product characteristics – manufacturer's instructions for use

5.1 Maximum sash weights

The maximum sash weight for individual hardware installation must not be exceeded. The construction element with the smallest possible permissible load defines the maximum weight of the sash. Application diagrams and component classification must be considered.

5.2 Sash sizes

Application diagrams show the relationship between the permissible sash rebate heights, depending on various glass weights i.e. total glass weight. The calculated sash dimensions in the rebate or the sash formats (portrait and/or landscape format), as well as the maximum sash weight must not be exceeded under any circumstances.

5.3 Hardware combination

The manufacturer's regulations, regarding the combination of hardware (i.e. the application of additional stay arms, the hardware design for anti-theft windows and balcony door sashes), must be followed.

5.4 Hardware functionality

Permanent hardware functionality can be ensured by consistently following the rules below:

- Professional installation of hardware components must be performed according to the attached instructions for installation,
- hardware assembly in the process of window installation is to be done professionally,
- the window manufacturer must deliver the instructions for use and maintenance to the user, along with the guidelines regarding product warranty,
- hardware as a whole can only consist of the original ARX building hardware; any product warranty is excluded for simultaneously using hardware parts, not originally belonging to the ARX building hardware.

6. Product maintenance

Hardware components, important for safety, must be checked at least once a year for fitting tightness and tight fitting. If necessary, the fixing screws can be additionally fastened and the component parts replaced. The following maintenance work must be performed at least once a year:

- Greasing and functional control of all the movable parts and all the locking points of the turn-only and tilt&turn hardware.
- only the cleaning and maintenance agents, which do not reduce the anti-corrosion hardware protection, may be used.

Hardware a – particularly in the vicinity of the pivot rest and the scissor-stay, as well as replacement parts and the unhinging & hinging of the active sash – must be provided by highly-qualified experts. In case of surface treatment for windows and balcony doors (e.g. varnishing), all the hardware components must be excluded from treatment; they must also be protected against potential contamination, caused by surface treatment.

6.1 Maintaining the quality of surface treatment

In normal climate, the galvanized coating is not damaged by corrosion, as long as condensed water is not produced in hardware parts or if the condensed water quickly dries up.

In order to maintain long-lasting quality of surface treatment and prevent adverse corrosion effects, the instructions below must be followed:

- Hardware and window rebates must be thoroughly aired (particularly during the construction phase)

by making sure that the elements mentioned are not exposed to moisture and condensed water,

- hardware must be protected against any covers or contamination with building materials (e.g. roughcast, dust, cement and the like),
- aggressive vapours in the window rebate (e.g. formic acid and acetic acid, ammonia, amino- and ammonium compounds, aldehyde, phenol, tannic acid etc.) may quickly lead to corrosion of hardware components in combination with a small amount of condensed water; in case of aggressive vapours, thorough airing of rebates on the windows and balcony doors must be provided; this is particularly important for windows and balcony doors made of oak and other types of wood, containing a large amount of tannic acid,
- gaskets with acetic acid or acidic net structure or gaskets, containing the above mentioned ingredients must not be used, as the direct contact with the gasket and its vapours may corrode the hardware surface,
- hardware can only be cleaned with soft, ph-neutral cleaning agent in diluted form; aggressive, acidiferous cleaners or abrasive cleaning agents, containing the above mentioned ingredients, must not be used at any time.

7. Information and instructions

In order to carry out duties of informing and giving instructions and performing maintenance according to »Consumer Protection Act«, the following publications are available:

- »Catalogues« for designers and authorized dealers
- »Installation instructions« and »factory drawings« for manufacturers of windows and balcony doors,
- »instructions for maintenance and cleaning« and »Instructions for use« for investors and users.

In order to ensure the functionality of the turn-only, turn&tilt and slide hardware for windows and balcony doors, the following rules must be observed:

- The designers are required to obtain information from the manufacturer or the authorized dealer, regarding the products, and act accordingly,
- the authorized dealers must pay attention to product information and the information mentioned herein, along with installation instructions, factory drawings and instructions for maintenance and cleaning; they must obtain instructions for use from the manufacturer and pass them on to manufacturers of windows and balcony doors,
- the manufacturers of windows and balcony doors must consider all the relevant product information and ask the manufacturer or authorized dealer for maintenance and
- cleaning instructions in particular, along with instructions for use and pass them on to investors and users.

All information regarding turn & tilt, turn or tilt only hardware systems for windows and balcony doors made of PVC should be observed. In case of non-compliance the manufacturer is exempt from liability.

HIGH-QUALITY, DURABLE, SIMPLE



ARX Coat – High quality surface protection

ARX Coat surface protection gives excellent appearance to building hardware and simultaneously ensures long-term and durable surface. It maintains very high corrosion resistance in severe conditions and extreme climate, exceeding Grade 5 of BS EN1670 (480 hours exposure to salt spray), thereby guaranteeing long-term and simple use.

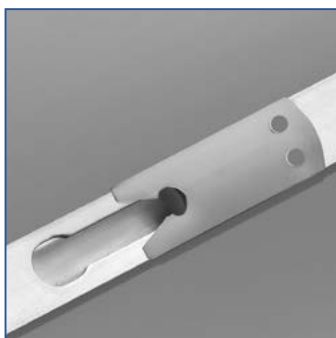

Stay guide with integrated anti-slam lock

Integrated tilt lock keeps the sash in tilted position, thus preventing sash slamming in windy conditions. It can be moved into alternative position, to reduce the tilt.



R cam

R cams incorporate a regulatory function which allows installer or user to optimize the window compression by +/- 1,2mm, thereby improving the sealing properties of windows and balcony doors. Moreover, the R cams provide smoother operation to window users who only need to apply a minimum force in order to operate the handle.

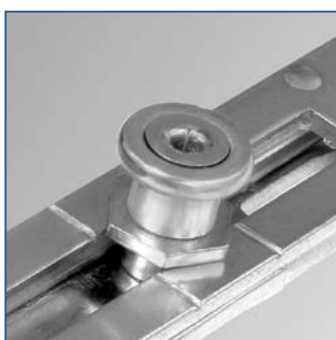

RS cam

RS cams provide superior level of security at closing points (with security strikers). Their height adjusts automatically to fit the air-gap between sash and frame. The compression can be regulated by +/- 0.8mm (hex key size 2.5 or spanner size 10). The rolling cam enables smoother and easier closing operation. RS cams can be used in combination with both security strikers or standard strikers.

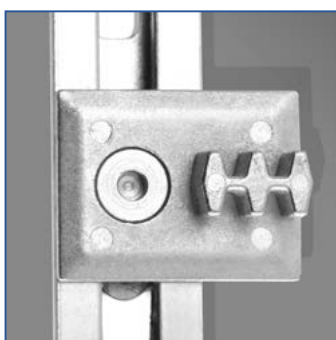

Night vent

Night vent allows gentle circulation of air through its gap in case of hot weather or in order to prevent glass condensation, or even mould forming. The window handle is set at the 45 degree angle between the two open positions.



Additional features

ARX Spin hardware is available in extensive variety of components, which can be combined into a number of turn & tilt solutions. ARX Spin therefore easily meets desires and requirements of different customers. For instance, a wide range of corner drives and shoot-bolts provides an excellent product choice to both very demanding and less stringent security requirements.

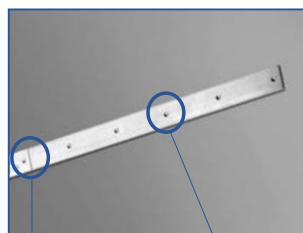

Range of use

Re-formed face plate



Reduced friction between driving rod and faceplate

The espagnolettes have been redesigned to reduce the contact between the gearplate and faceplate, thereby reducing potential damage to surface protection.

Uniform length of redesigned espagnolettes



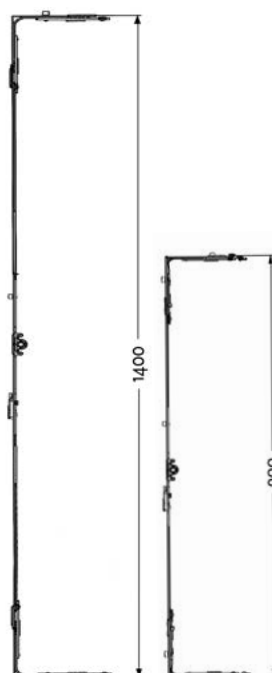













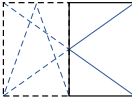

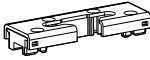

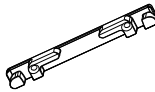



A special feature of ARX Spin hardware is also uniform length of its espagnolettes. A one-size espagnolette can fit a range of sash dimension, covering up to 50% of total requirement. Each espagnolette can be cropped within the marked cut-off area.



SRH 900 - 1400 mm
(50% Volume)

Symbols

In the part describing the ARX Spin, different symbols, diagrams and tables are used in order to provide a clear picture and demonstration of the hardware application. The meanings are as follows:

	Turn & tilt		R cam
	Turn only		RS cam
	Tilt only		Standard striker
	Turn only - sec. sash		Security striker
	Rebate sash height		T&Ti security striker
	Rebate sash width		T&T striker
	Handle height		Screws
	R cam		Mishandling device position
	RS cam		Packaging
	Night vent		Warning
	Max. sash mass		Length / dimension
	Material number		Hardware shortening
	Orientation / position		

Abbreviation	Description	Units
SRH	SASH REBATE HEIGHT	mm
SRW	SASH REBATE WIDTH	mm
HH	HANDLE HEIGHT	mm
MS	MISHANDLING DEVICE POSITION	mm
BS	BACKSET	mm
LH	LOCK HOLE POSITION	mm
HL	HANDLE LENGTH	mm

Fixing guidelines

Screws

In order to fix hardware components, silver galvanized, steel construction screws of 4,2 x 25 mm (1134209) and 4,2 x 35 mm (1134210) are used. The 35 mm long screws are used for the hinges and the 25 mm long screws are used for all the rest of hardware. The window manufacturer must ensure sufficient fixing of hardware components. If necessary, the manufacturer of construction screws may also be included in the process of installing hardware.

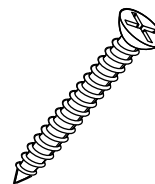

Fixing of hardware

Sash mass [Kg]	F [N]
60	1650
70	1900
80	2200
90	2450
100	2710
110	3000
120	3250
130	3500
140	3900
150	4200
160	4400
170	4710
180	5000
190	5300
200	5500

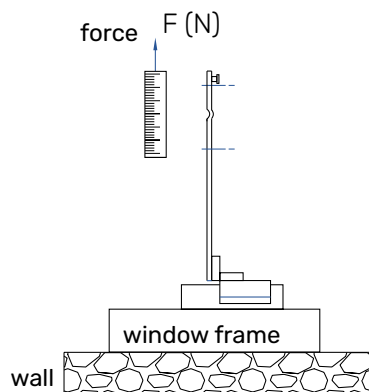

Fixing

When fixing safety relevant bearing hardware components (stay bearing and pivot rest), the vertical tractive force on the sash level must reach the values according to the following table (the tractive force values in dependence of the sash weight according to directive TDK).

The necessity of reinforcement

The values in the table for sashes up to 80 kg in weight are normally achieved if high-quality screws are used for fixing and the fixing on the profile is performed through at least two profile walls. The thickness of the first profile wall must be at least 2,8 mm. For sash weights over 80 kg, a supplementary fixing into the reinforcement profile or profile insertions in accordance with the profile system, is necessary. Required values can be achieved without additional measures by using the bearing parts on sashes up to 100 kg in weight.

Gaskets with acetic acid net structure must not be used, as their use may lead to corrosion of hardware components. Guidelines regarding the window glazing technique must be followed.

The use of related hardware types

Different options within the individual hardware system (e.g. tilt hardware) must be considered according to the product information, purpose, misuse, product characteristics, maintenance, information and instructions in regard to the characteristics of the hardware assembly.

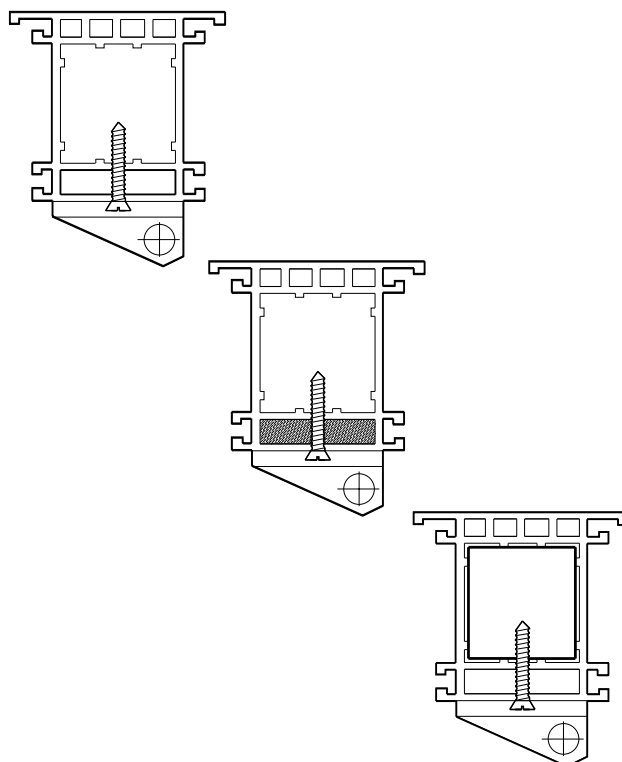

Profile dimensioning for PVC

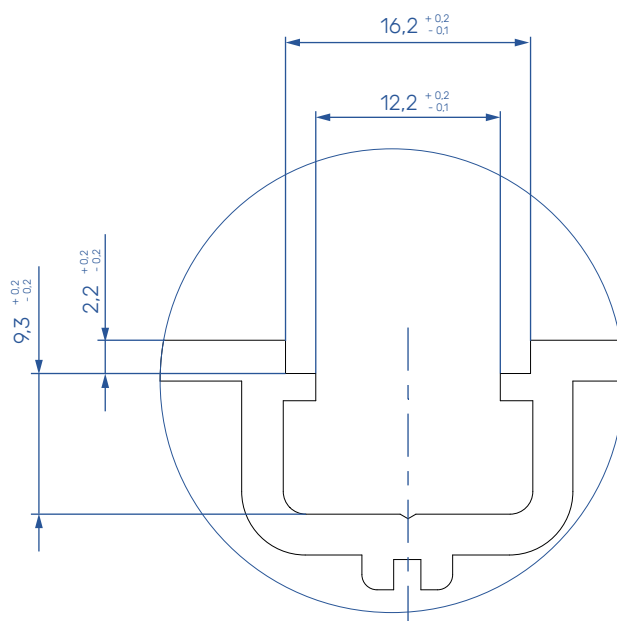
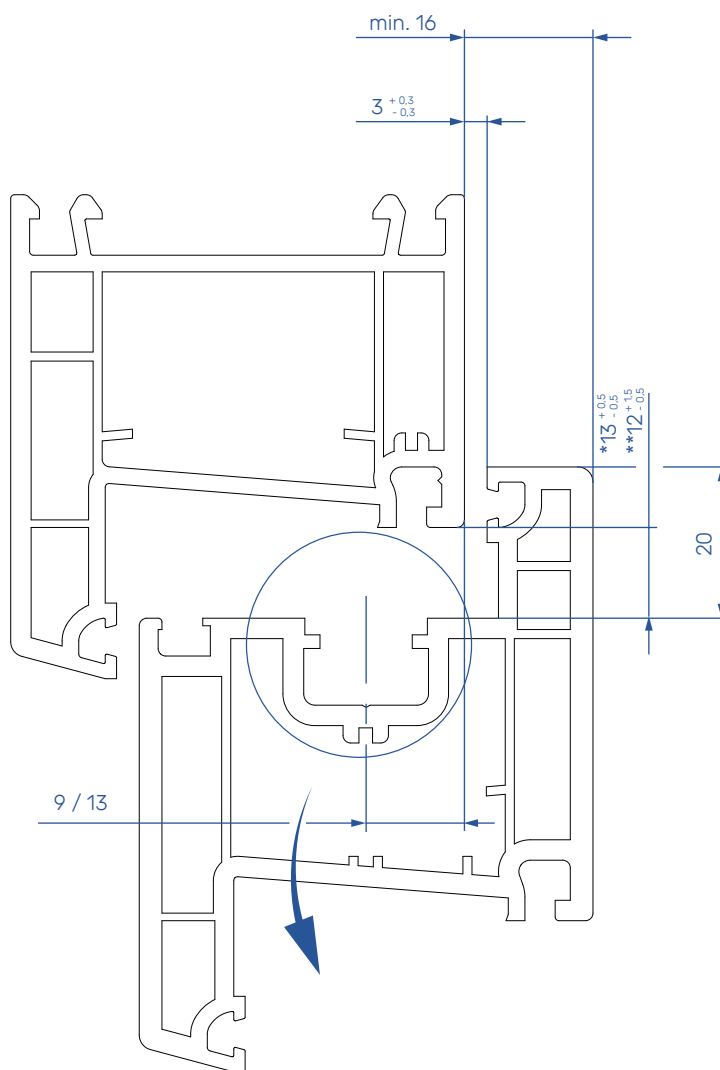

* CONCEALED HINGES
** FACE-FIT HINGES



Typical hardware schemes

Basic schemes
Proposed guidelines

T&TI | FACE-FIT HINGE SIDE

Fixed handle height

1 T&T KV ESPAGNOLETTE BS 14,5 mm

Sash rebate height	Handle height	Length	Material
320-460 ¹⁾²⁾	120	320	1105430
461-600 ³⁾	170	410	1118431
601-800	263	520	1115131
801-1000	413	720	1115132
801-1000	413	720	1 R 1115133
1001-1200	513	920	1 R 1115134
1201-1400	563	1120	1 R 1115135
1401-1600	563	1320	1 R 1115136
1601-1800	563	1520	1 R 1115137
1601-1800	1000	1520	1 R 1115167
1801-2000	1000	1720	2 R 1115138
2001-2200	1000	1920	2 R 1115139
2201-2400	1000	2120	2 R 1115140

2 CORNER DRIVE - TOP

STANDARD CORNER DRIVE	1 R	1103158
SHORT CORNER DRIVE	1 R	1103162

3 SASH STAY GUIDE

Sash rebate width	Type / length	Material Nr.
250-410 ⁴⁾	150 / 290	1123308
411-610	250 / 470	1083038
611-810	350 / 670	1083039
811-1010	500 / 870	1 R 1083040
1011-1210	500 / 1070	1 R 1083041
1211-1400	500 / 1270	1 R 1083042

4 STAY ARM

SYSTEM 12/20-13

Sash rebate width	Type / length	Pos.	Material
250-410 ⁴⁾	150	L	1123306
		R	1123307
411-610	250	L	1083016
		R	1083017
611-810	350	L	1083018
		R	1083019
811-1400	500	L	1083020
		R	1083021

5 CENTER LOCK - VERTICAL

Sash rebate height	Length	Material
801-1200	500 / 550	2 R 1083058
1201-1600	800 / 850	2 R 1083059
1601-2200	1500 / 1550	3 R 1083060
2201-2400	1950 / 2000	4 R 1083064

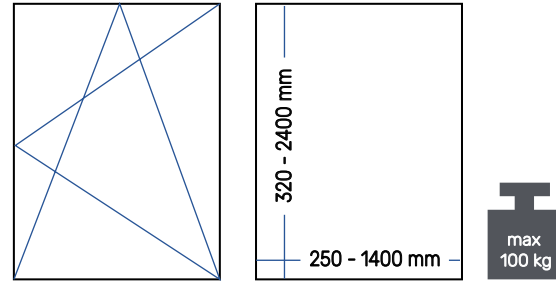

6 CENTER LOCK - HORIZONTAL

Sash rebate width	Length	Material
801-1200	400	1 R 1083061
1201-1400	600	1 R 1083062

7 CORNER DRIVE - BOTTOM

STANDARD CORNER DRIVE	1 RS	1100983
SHORT CORNER DRIVE	1 RS	1100986

8 STAY BEARING

STAY BEARING WITH PIN K3	1083250
--------------------------	---------

9 CORNER HINGE

CORNER HINGE K3	1083241
-----------------	---------

10 CORNER PIVOT REST

CORNER PIVOT REST K3	1083247
----------------------	---------

11 MISHANDLING DEVICE

SASH PART	1093907
FRAME PART	PAGE 141

12 STRIKERS

T&Ti STRIKER	PAGE 137
STRIKER	PAGE 139

13 COVER CAPS

STAY BEARING	PAGE 134
STAY ARM	PAGE 134
CORNER HINGE	PAGE 134
CORNER PIVOT REST	PAGE 134
CORNER PIVOT REST - FLAT	PAGE 134

¹⁾ WITH INTEGRATED CORNER DRIVE 1 RS ON BOTTOM

²⁾ MISHANDLING DEVICE NOT AVAILABLE

³⁾ MUST USE SHORT CORNER DRIVE 1100986 ON BOTTOM

⁴⁾ SRW = 250 - 340 mm, WITH SHORT CORNER DRIVE ON TOP

* SRH < 500 mm, move the anti-slam device to reduce the tilt

APPLICATION DIAGRAM

Sash rebate height (SRH) in mm

Sash rebate width (SRW) in mm

The application diagrams are generated according to IFT guidelines.

Glass mass [kg/m²]

- Impermissible size range
- 20 kg/m²
- 30 kg/m²
- 40 kg/m²
- 50 kg/m²
- 60 kg/m²
- 70 kg/m²

Conditions for the use of the application diagram:

- Bearing loads:
 - top hinge: 2710 N
 - bottom hinge: 2890 N
- The following values are to be observed with all window systems:
 - width/height ratio $Q_{B/Ht} \leq 1,5$
 - sash size $H_{max} \leq 3 \text{ m}^2$
 - glass deduction dim. CG: $\geq 28 \text{ mm}$
 - profile weight PG: $\leq 3,25 \text{ kg/m}$

T&TI | FACE-FIT HINGE SIDE

Centered / variable handle height

1 T&T ESPAGNOLETTE M BS 14,5 mm

Sash rebate height	Handle height	Length	Material
420-660 ¹⁾	210-330	380	1083117
600-1000	300-500	720	1 R 1088473
900-1400	450-700	1120	1 R 1098964
1401-1800	701-900	1520	1 R 1098965
1601-2000	801-1000	1720	2 R 1098966
2001-2400	1001-1200	2120	2 R 1098967

2 CORNER DRIVE - TOP

STANDARD CORNER DRIVE	1 R	1103158
SHORT CORNER DRIVE	1 R	1103162

3 SASH STAY GUIDE

Sash rebate width	Type / length	Material Nr.
250-410 ²⁾	150 / 290	1123308
411-610	250 / 470	1083038
611-810	350 / 670	1083039
811-1010	500 / 870	1 R 1083040
1011-1210	500 / 1070	1 R 1083041
1211-1400	500 / 1270	1 R 1083042

4 STAY ARM

SYSTEM 12/20-13

Sash rebate width	Type / length	Pos.	Material
250-410 ²⁾	150	L	1123306
		R	1123307
411-610	250	L	1083016
		R	1083017
611-810	350	L	1083018
		R	1083019
811-1400	500	L	1083020
		R	1083021

5 CENTER LOCK - VERTICAL

Sash rebate height	Length	Material
801-1200	500 / 550	2 R 1083058
1201-1600	800 / 850	2 R 1083059
1601-2200	1500 / 1550	3 R 1083060
2201-2400	1950 / 2000	4 R 1083064

6 CENTER LOCK - HORIZONTAL

Sash rebate width	Length	Material
801-1200	400	1 R 1083061
1201-1400	600	1 R 1083062

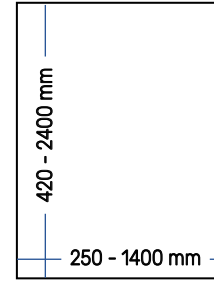
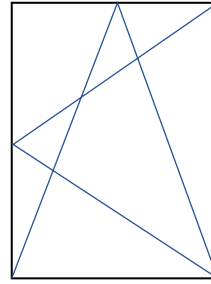

7 CORNER DRIVE - BOTTOM

STANDARD CORNER DRIVE 1 RS 1100983

8 STAY BEARING

STAY BEARING WITH PIN K3 1083250

9 CORNER HINGE

CORNER HINGE K3 1083241

10 CORNER PIVOT REST

CORNER PIVOT REST K3 1083247

11 MISHANDLING DEVICE

SASH PART 1093907
FRAME PART PAGE 141

12 STRIKERS

T&Ti STRIKER PAGE 137
STRIKER PAGE 139

13 COVER CAPS

STAY BEARING PAGE 134
STAY ARM PAGE 134
CORNER HINGE PAGE 134
CORNER PIVOT REST PAGE 134
CORNER PIVOT REST - FLAT PAGE 134

¹⁾ MISHANDLING DEVICE NOT AVAILABLE

²⁾ SRW = 250 - 340 mm, WITH SHORT CORNER DRIVE ON TOP

* SRH < 500 mm, move the anti-slam device to reduce the tilt

APPLICATION DIAGRAM

Sash rebate height (SRH) in mm

Sash rebate width (SRW) in mm

Glass mass [kg/m²]

- Impermissible size range
- 20 kg/m²
- 30 kg/m²
- 40 kg/m²
- 50 kg/m²
- 60 kg/m²
- 70 kg/m²

Conditions for the use of the application diagram:

- Bearing loads:
 - top hinge: 2710 N
 - bottom hinge: 2890 N
- The following values are to be observed with all window systems:
 - width/height ratio $Q_{g/h}$: $\leq 1,5$
 - sash size H_{max} : $\leq 3 \text{ m}^2$
 - glass deduction dim. CG: $\geq 28 \text{ mm}$
 - profile weight PG: $\leq 3,25 \text{ kg/m}$

The application diagrams are generated according to IFT guidelines.

T&T | FACE-FIT HINGE SIDE

Fixed handle height

1 T&T KV ESPAGNOLETTE BS 14,5 mm

Sash rebate height	Handle height	Length	Material
550-600	260	410	1118431
601-800	263	520	1115131
801-1000	413	720	1115132
801-1000	413	720	1 R 1115133
1001-1200	513	920	1 R 1115134
1201-1400	563	1120	1 R 1115135
1401-1600	563	1320	1 R 1115136
1601-1800	563	1520	1 R 1115137
1601-1800	1000	1520	1 R 1115167
1801-2000	1000	1720	2 R 1115138
2001-2200	1000	1920	2 R 1115139
2201-2400	1000	2120	2 R 1115140

2 CORNER DRIVE

STANDARD CORNER DRIVE	1 R	1103158
SHORT CORNER DRIVE	1 R	1103162

3 SASH STAY GUIDE

Sash rebate width	Type / length	Material Nr.
250-410 ¹⁾	150 / 290	1123308
411-610	250 / 470	1083038
611-810	350 / 670	1083039
811-1010	500 / 870	1 R 1083040
1011-1210	500 / 1070	1 R 1083041
1211-1400	500 / 1270	1 R 1083042

4 STAY ARM

SYSTEM 12/20-13

Sash rebate width	Type / length	Pos.	Material
250-410 ¹⁾	150	L	1123306
		R	1123307
411-610	250	L	1083016
		R	1083017
611-810	350	L	1083018
		R	1083019
811-1400	500	L	1083020
		R	1083021

5 CENTER LOCK - VERTICAL

Sash rebate height	Length	Material
801-1200	500 / 550	2 R 1083058
1201-1600	800 / 850	2 R 1083059
1601-2200	1500 / 1550	3 R 1083060
2201-2400	1950 / 2000	4 R 1083064

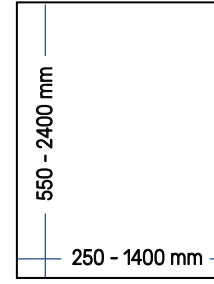
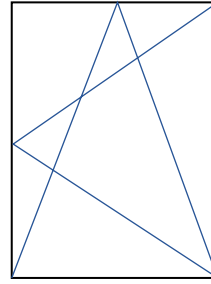

6 CENTER LOCK - HORIZONTAL

Sash rebate width	Length	Material
801-1200	500 / 550	2 R 1083058
1201-1400	800 / 850	2 R 1083059

7 TILT LOCK BOLT

TILT LOCK BOLT SRH < 1000 mm	1102388
TILT LOCK BOLT SRH > 1001 mm	1102391

8 STAY BEARING

STAY BEARING WITH PIN K3	1083250
--------------------------	---------

9 CORNER HINGE

CORNER HINGE K3	1083241
-----------------	---------

10 CORNER PIVOT REST

CORNER PIVOT REST K3	1083247
----------------------	---------

11 MISHANDLING DEVICE

SASH PART	1093907
FRAME PART	PAGE 141

12 STRIKERS

T&T STRIKER	PAGE 136
STRIKER	PAGE 139

13 COVER CAPS

STAY BEARING	PAGE 134
STAY ARM	PAGE 134
CORNER HINGE	PAGE 134
CORNER PIVOT REST	PAGE 134
CORNER PIVOT REST - FLAT	PAGE 134

¹⁾ SRW = 250 - 340 mm, WITH SHORT CORNER DRIVE ON TOP

* SRH < 500 mm, move the anti-slam device to reduce the tilt

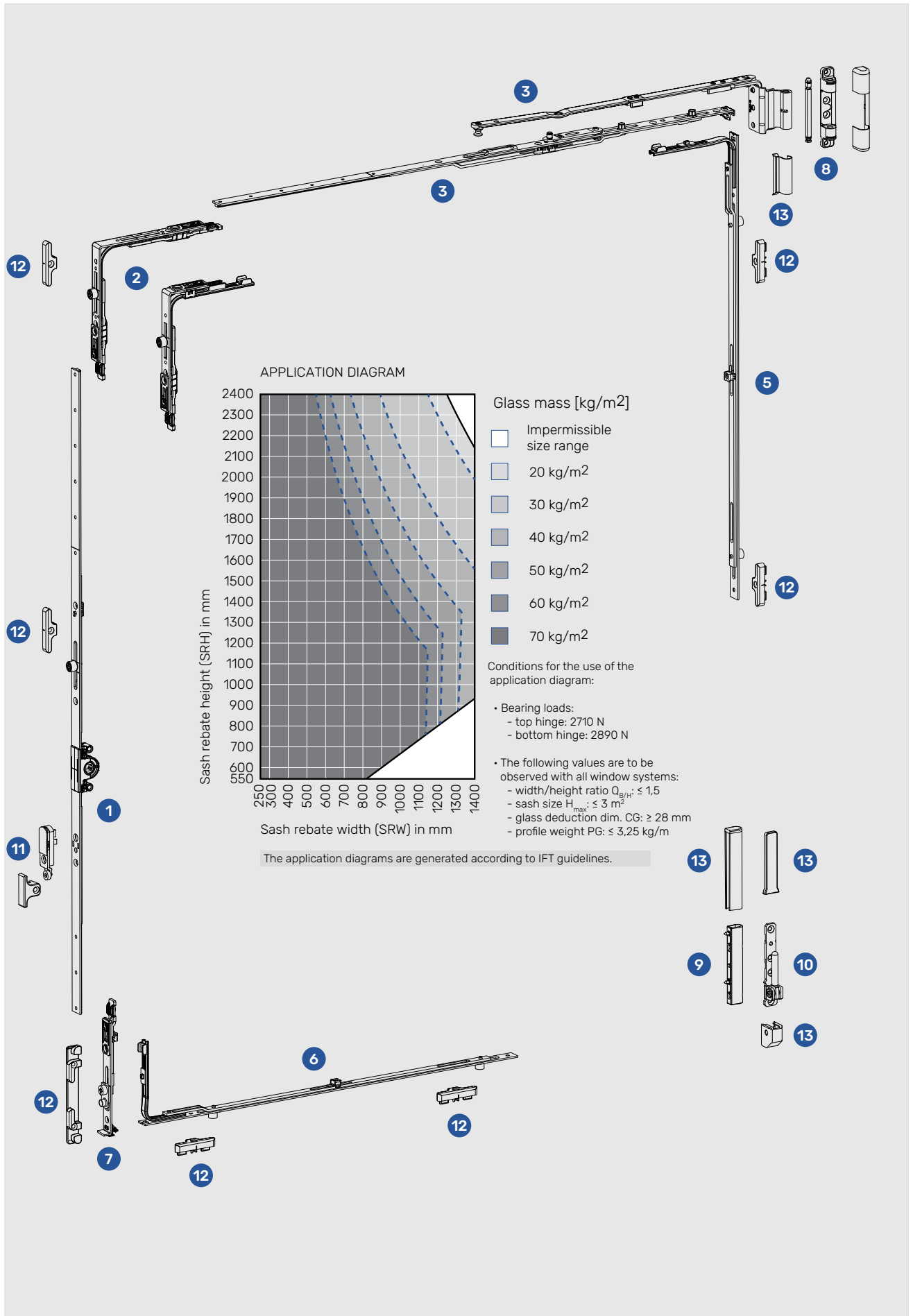

T&T | FACE-FIT HINGE SIDE

Centered / variable handle height

1 T&T ESPAGNOLETTE M BS 14,5 mm

Sash rebate height	Handle height	Length	Material
420-660 ¹⁾	210-330	380	1083117
600-1000	300-500	720	1 R 1088473
900-1400	450-700	1120	1 R 1098964
1401-1800	701-900	1520	1 R 1098965
1601-2000	801-1000	1720	2 R 1098966
2001-2400	1001-1200	2120	2 R 1098967

2 CORNER DRIVE

STANDARD CORNER DRIVE	1 R	1103158
SHORT CORNER DRIVE	1 R	1103162

3 SASH STAY GUIDE

Sash rebate width	Type / length	Material Nr.
250-410 ²⁾	150 / 290	1123308
411-610	250 / 470	1083038
611-810	350 / 670	1083039
811-1010	500 / 870	1 R 1083040
1011-1210	500 / 1070	1 R 1083041
1211-1400	500 / 1270	1 R 1083042

4 STAY ARM

SYSTEM 12/20-13

Sash rebate width	Type / length	Pos.	Material
250-410 ²⁾	150	L	1123306
		R	1123307
411-610	250	L	1083016
		R	1083017
611-810	350	L	1083018
		R	1083019
811-1400	500	L	1083020
		R	1083021

5 CENTER LOCK - VERTICAL

Sash rebate height	Length	Material
801-1200	500 / 550	2 R 1083058
1201-1600	800 / 850	2 R 1083059
1601-2200	1500 / 1550	3 R 1083060
2201-2400	1950 / 2000	4 R 1083064

6 CENTER LOCK - HORIZONTAL

Sash rebate width	Length	Material
801-1200	500 / 550	2 R 1083058
1201-1400	800 / 850	2 R 1083059

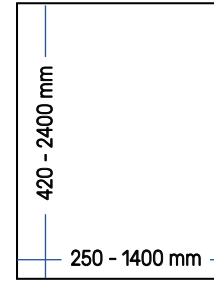
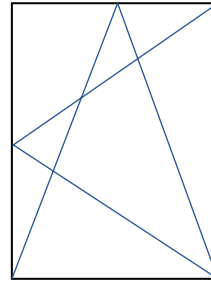

7 TILT LOCK BOLT

TILT LOCK BOLT SRH < 1000 mm	1102388
TILT LOCK BOLT SRH > 1001 mm	1102391

8 STAY BEARING

STAY BEARING WITH PIN K3	1083250
--------------------------	---------

9 CORNER HINGE

CORNER HINGE K3	1083241
-----------------	---------

10 CORNER PIVOT REST

CORNER PIVOT REST K3	1083247
----------------------	---------

11 MISHANDLING DEVICE

SASH PART	1093907
FRAME PART	PAGE 141

12 STRIKERS

T&T STRIKER	PAGE 136
STRIKER	PAGE 139

13 COVER CAPS

STAY BEARING	PAGE 134
STAY ARM	PAGE 134
CORNER HINGE	PAGE 134
CORNER PIVOT REST	PAGE 134
CORNER PIVOT REST - FLAT	PAGE 134

¹⁾ MISHANDLING DEVICE NOT AVAILABLE

²⁾ SRW = 250 - 340 mm, WITH SHORT CORNER DRIVE ON TOP

* SRH < 500 mm, move the anti-slam device to reduce the tilt

APPLICATION DIAGRAM

Sash rebate height (SRH) in mm

Sash rebate width (SRW) in mm

Glass mass [kg/m²]

- Impermissible size range
- 20 kg/m²
- 30 kg/m²
- 40 kg/m²
- 50 kg/m²
- 60 kg/m²
- 70 kg/m²

Conditions for the use of the application diagram:

- Bearing loads:
 - top hinge: 2710 N
 - bottom hinge: 2890 N
- The following values are to be observed with all window systems:
 - width/height ratio $\alpha_{g/h} \leq 1,5$
 - sash size $H_{max} \leq 3 \text{ m}^2$
 - glass deduction dim. CG: $\geq 28 \text{ mm}$
 - profile weight PG: $\leq 3,25 \text{ kg/m}$

The application diagrams are generated according to IFT guidelines.

T&TI RC 1 | FACE-FIT HINGE SIDE

Fixed handle height

1 T&T KV ESPAGNOLETTE BS 14,5 mm

Sash rebate height	Handle height	Length	Material
320-460 ^{1 2)}	120	320	1105430
461-600 ³⁾	170	410	1118431
601-800	263	520	1115131
801-1000	413	720	1115132
801-1000	413	720	1 R 1115133
1001-1200	513	920	1 R 1115134
1201-1400	563	1120	1 R 1115135
1401-1600	563	1320	1 R 1115136
1601-1800	563	1520	1 R 1115137
1601-1800	1000	1520	1 R 1115167
1801-2000	1000	1720	2 R 1115138
2001-2200	1000	1920	2 R 1115139
2201-2400	1000	2120	2 R 1115140

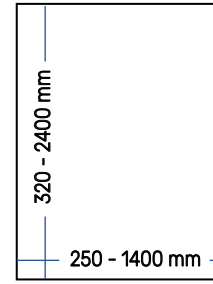
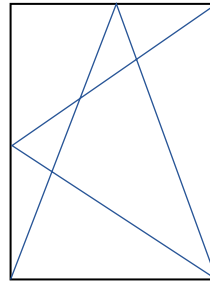

250 - 1400 mm

2 CORNER DRIVE - TOP

STANDARD CORNER DRIVE	1 RS	1100983
SHORT CORNER DRIVE	1 RS	1100986

3 SASH STAY GUIDE

Sash rebate width	Type / length	Material Nr.
250-410 ⁴⁾	150 / 290	1123308
411-610	250 / 470	1083038
611-810	350 / 670	1083039
811-1010	500 / 870	1 R 1083040
1011-1210	500 / 1070	1 R 1083041
1211-1400	500 / 1270	1 R 1083042

4 STAY ARM

ONLY SYSTEM 12/20-13

Sash rebate width	Type / length	Pos.	Material
250-410 ⁴⁾	150	L	1123306
		R	1123307
411-610	250	L	1083016
		R	1083017
611-810	350	L	1083018
		R	1083019
811-1400	500	L	1083020
		R	1083021

5 SECURITY CORNER LOCK

SECURITY CORNER LOCK 180 mm	1 RS	1100987
-----------------------------	------	---------

6 CENTER LOCK - VERTICAL

Sash rebate height	Length	Material
801-1200	400 1 R	1083061
1201-1600	600 1 R	1083062
1601-2000	600 EX 1 R + 600 1 R	1102900+1083062
2001-2200	2 x 600 EX 1 R + 400 1 R	2x1102900+1083061
2201-2400	2 x 600 EX 1 R + 600 1 R	2x1102900+1083062

7 CENTER LOCK - HORIZONTAL

Sash rebate width	Length	Material
340-540	200 1 RS	1101005
541-740	400 1 RS	1101006
741-940	600 1 RS	1101012
941-1140	600 EX 1 R + 200 1 RS	1102900+1101005
1141-1340	600 EX 1 R + 400 1 RS	1102900+1101006
1341-1400	600 EX 1 R + 600 1 RS	1102900+1101012

8 CORNER DRIVE - BOTTOM

STANDARD CORNER DRIVE	1 RS	1100983
SHORT CORNER DRIVE	1 RS	1100986

9 STAY BEARING

STAY BEARING WITH PIN K6	1105598
--------------------------	---------

10 CORNER HINGE

CORNER HINGE K6	1083242
-----------------	---------

11 CORNER PIVOT REST

CORNER PIVOT REST K6	1105596
----------------------	---------

12 MISHANDLING DEVICE

SASH PART	1093907
FRAME PART	PAGE 141

13 STRIKERS

T&Ti STRIKER	PAGE 137
SECURITY STRIKER	PAGE 140
STRIKER	PAGE 139

14 GROOVE SPACER

GROOVE SPACER 12 mm	1127521
---------------------	---------

15 COVER CAPS

STAY BEARING	PAGE 134
STAY ARM	PAGE 134
CORNER HINGE	PAGE 134
CORNER PIVOT REST	PAGE 134
CORNER PIVOT REST - FLAT	PAGE 134

16 ARX HANDLE

ARX HANDLE - lockable	PAGE 177
-----------------------	----------

¹⁾ WITH INTEGRATED CORNER DRIVE 1 RS ON BOTTOM

²⁾ MISHANDLING DEVICE NOT AVAILABLE

³⁾ MUST USE SHORT CORNER DRIVE **1100986** ON BOTTOM

⁴⁾ SRW = 250 - 340 mm, WITH SHORT CORNER DRIVE ON TOP

* 4 security locking points

* lockable handle is necessary

* groove spacers are necessary

* SRH < 500 mm, move the anti-slam device to reduce the tilt

* for double sash window, position the RS cam on the upper corner drive into vertical position

APPLICATION DIAGRAM

Sash rebate height (SRH) in mm

Sash rebate width (SRW) in mm

Glass mass [kg/m²]

- Impermissible size range
- 20 kg/m²
- 30 kg/m²
- 40 kg/m²
- 50 kg/m²
- 60 kg/m²
- 70 kg/m²

Category of resistance: P4A glass

Conditions for the use of the application diagram:

- Bearing loads:
 - top hinge: 2710 N
 - bottom hinge: 2890 N
- The following values are to be observed with all window systems:
 - width/height ratio $Q_{B/H} \leq 1,5$
 - sash size $H_{max} \leq 3 \text{ m}^2$
 - glass deduction dim. CG: $\geq 28 \text{ mm}$
 - profile weight PG: $\leq 3,25 \text{ kg/m}$

The application diagrams are generated according to IFT guidelines.

RC1 security is a system test meaning, that ARX as a hardware producer can only give recommendations for hardware assembled into finished product (window). ARX can't guarantee that the test will be positive solely on the base of hardware recommendations.

T&TI RC 1 | FACE-FIT HINGE SIDE

Centered / variable handle height

1 T&T ESPAGNOLETTE M BS 14,5 mm

Sash rebate height	Handle height	Length	Material
420-660 ¹⁾	210-330	380	1083117
600-1000	300-500	720	1 R 1088473
900-1400	450-700	1120	1 R 1098964
1401-1800	701-900	1520	1 R 1098965
1601-2000	801-1000	1720	2 R 1098966
2001-2400	1001-1200	2120	2 R 1098967

2 CORNER DRIVE - TOP

STANDARD CORNER DRIVE	1 RS	1100983
SHORT CORNER DRIVE	1 RS	1100986

3 SASH STAY GUIDE

Sash rebate width	Type / length	Material Nr.
250-410 ²⁾	150 / 290	1123308
411-610	250 / 470	1083038
611-810	350 / 670	1083039
811-1010	500 / 870	1 R 1083040
1011-1210	500 / 1070	1 R 1083041
1211-1400	500 / 1270	1 R 1083042

4 STAY ARM

ONLY SYSTEM 12/20-13

Sash rebate width	Type / length	Pos.	Material
250-410 ²⁾	150	L	1123306
		R	1123307
411-610	250	L	1083016
		R	1083017
611-810	350	L	1083018
		R	1083019
811-1400	500	L	1083020
		R	1083021

5 SECURITY CORNER LOCK

SECURITY CORNER LOCK 180 mm	1 RS	1100987
-----------------------------	------	---------

6 CENTER LOCK - VERTICAL

Sash rebate height	Length	Material
801-1200	400 1 R	1083061
1201-1600	600 1 R	1083062
1601-2000	600 EX 1 R + 600 1 R	1102900+1083062
2001-2200	2 x 600 EX 1 R + 400 1 R	2x1102900+1083061
2201-2400	2 x 600 EX 1 R + 600 1 R	2x1102900+1083062

7 CENTER LOCK - HORIZONTAL

Sash rebate width	Length	Material
340-540	200 1 RS	1101005
541-740	400 1 RS	1101006
741-940	600 1 RS	1101012
941-1140	600 EX 1 R + 200 1 RS	1102900+1101005
1141-1340	600 EX 1 R + 400 1 RS	1102900+1101006
1341-1400	600 EX 1 R + 600 1 RS	1102900+1101012

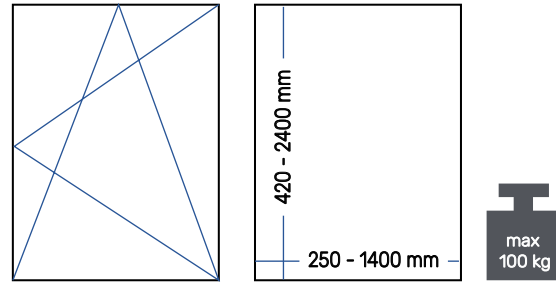

8 CORNER DRIVE - BOTTOM

STANDARD CORNER DRIVE	1 RS	1100983
-----------------------	------	---------

9 STAY BEARING

STAY BEARING WITH PIN K6	1105598
--------------------------	---------

10 CORNER HINGE

CORNER HINGE K6	1083242
-----------------	---------

11 CORNER PIVOT REST

CORNER PIVOT REST K6	1105596
----------------------	---------

12 MISHANDLING DEVICE

SASH PART	1093907
FRAME PART	PAGE 141

13 STRIKERS

T&TI STRIKER	PAGE 137
SECURITY STRIKER	PAGE 140
STRIKER	PAGE 139

14 GROOVE SPACER

GROOVE SPACER 12 mm	1127521
---------------------	---------

15 COVER CAPS

STAY BEARING	PAGE 134
STAY ARM	PAGE 134
CORNER HINGE	PAGE 134
CORNER PIVOT REST	PAGE 134
CORNER PIVOT REST - FLAT	PAGE 134

16 ARX HANDLE

ARX HANDLE - lockable	PAGE 177
-----------------------	----------

- * 4 security locking points
- * lockable handle is necessary
- * groove spacers are necessary
- * SRH < 500 mm, move the anti-slam device to reduce the tilt
- * for double sash window, position the RS cam on the upper corner drive into vertical position

¹⁾ MISHANDLING DEVICE NOT AVAILABLE

²⁾ SRW = 250 - 340 mm, WITH SHORT CORNER DRIVE ON TOP

APPLICATION DIAGRAM

Sash rebate height (SRH) in mm

Sash rebate width (SRW) in mm

Glass mass [kg/m²]

- Impermissible size range
- 20 kg/m²
- 30 kg/m²
- 40 kg/m²
- 50 kg/m²
- 60 kg/m²
- 70 kg/m²

Category of resistance: P4A glass

Conditions for the use of the application diagram:

- Bearing loads:
 - top hinge: 2710 N
 - bottom hinge: 2890 N
- The following values are to be observed with all window systems:
 - width/height ratio Q_{grH} : $\leq 1,5$
 - sash size H_{max} : $\leq 3 \text{ m}^2$
 - glass deduction dim. CG: $\geq 28 \text{ mm}$
 - profile weight PG: $\leq 3,25 \text{ kg/m}$

The application diagrams are generated according to IFT guidelines.

RC1 security is a system test meaning, that ARX as a hardware producer can only give recommendations for hardware assembled into finished product (window). ARX can't guarantee that the test will be positive solely on the base of hardware recommendations.

T&TI RC 2 | FACE-FIT HINGE SIDE

Fixed handle height

1 T&T KV ESPAGNOLETTE BS 14,5 mm

Sash rebate height	Handle height	Length	Material
320-460 ^{1,2)}	120	320	1105430
461-600 ³⁾	170	410	1118431
601-800	263	520	1115131
801-1000	413	720	1 RS 1142916
1001-1200	513	920	1 RS 1142919
1201-1400	563	1120	1 RS 1142921
1401-1600	563	1320	1 RS 1142922
1601-1800	563	1520	1 RS 1142923
1601-1800	1000	1520	1 RS 1142924
1801-2000	1000	1720	2 RS 1142925
2001-2200	1000	1920	2 RS 1142926
2201-2400	1000	2120	2 RS 1142927

2 CORNER DRIVE - TOP

STANDARD CORNER DRIVE 2 RS 1100984

3 SASH STAY GUIDE

Sash rebate width	Type / length	Material Nr.
410-610	250 / 470	1083038
611-810	350 / 670	1083039
811-1010	500 / 870	1 RS 1100978
1011-1210	500 / 1070	1 RS 1100980
1211-1400	500 / 1270	1 RS 1100981

4 STAY ARM

ONLY SYSTEM 12/20-13

Sash rebate width	Type / length	Pos.	Material
410-610	250	L	1083016
		R	1083017
611-810	350	L	1083018
		R	1083019
811-1400	500	L	1083020
		R	1083021

5 SECURITY CORNER LOCK

SECURITY CORNER LOCK 180 mm 1 RS 1100987

6 CENTER LOCK - VERTICAL

Sash rebate height	Length	Material
400-600	200 1 RS	1101005
601-800	400 1 RS	1101006
801-1000	600 1 RS	1101012
1001-1200	400 EX 1 RS + 400 1 RS	1101016 + 1101006
1201-1400	600 EX 1 RS + 400 1 RS	1101017 + 1101006
1401-1600	600 EX 1 RS + 600 1 RS	1101017 + 1101012
1601-1800	2x 600 EX 1 RS + 200 1 RS	2x 1101017 + 1101005
1801-2000	2x 600 EX 1 RS + 400 1 RS	2x 1101017 + 1101006
2001-2400	2x 600 EX 1 RS + 600 1 RS	2x 1101017 + 1101012

7 CENTER LOCK - HORIZONTAL

Sash rebate width	Length	Material
410-540	200 1 RS	1101005
541-740	400 1 RS	1101006
741-940	600 1 RS	1101012
941-1140	400 EX 1 RS + 400 1 RS	1101016 + 1101006
1141-1340	600 EX 1 RS + 400 1 RS	1101017 + 1101006
1341-1400	600 EX 1 RS + 600 1 RS	1101017 + 1101012

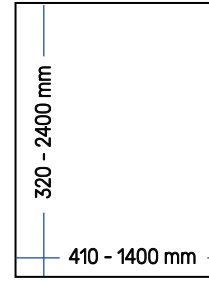
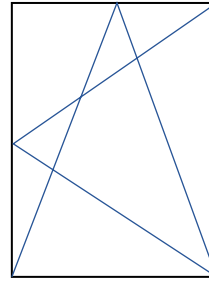

8 CORNER DRIVE - BOTTOM

STANDARD CORNER DRIVE 2 RS 1100984
SHORT CORNER DRIVE 1 RS 1100986

9 STAY BEARING

STAY BEARING WITH PIN K6 1105598

10 CORNER HINGE

CORNER HINGE K6 1083242

11 CORNER PIVOT REST

CORNER PIVOT REST K6 1105596

12 MISHANDLING DEVICE

SASH PART 1093907
FRAME PART PAGE 141

13 STRIKERS

T&Ti STRIKER PAGE 137
SECURITY STRIKER PAGE 140

14 GROOVE SPACER

GROOVE SPACER 12 mm 1127521

15 COVER CAPS

STAY BEARING PAGE 134
STAY ARM PAGE 134
CORNER HINGE PAGE 134
CORNER PIVOT REST PAGE 134
CORNER PIVOT REST - FLAT PAGE 134

16 ARX HANDLE

ARX HANDLE - lockable PAGE 175

17 DRILLING PROTECTION

DRILLING PROTECTION RC2 1112748

¹⁾ WITH INTEGRATED CORNER DRIVE 1 RS ON BOTTOM

²⁾ MISHANDLING DEVICE NOT AVAILABLE

³⁾ MUST USE SHORT CORNER DRIVE 1100986 ON BOTTOM

* drilling protection is necessary

* lockable handle is necessary

* groove spacers are necessary

* SRH < 500 mm, move the anti-slam device to reduce the tilt

APPLICATION DIAGRAM

Sash rebate height (SRH) in mm

Sash rebate width (SRW) in mm

Glass mass [kg/m²]

- Impermissible size range
- 20 kg/m²
- 30 kg/m²
- 40 kg/m²
- 50 kg/m²
- 60 kg/m²
- 70 kg/m²

Category of resistance: P4A glass

Conditions for the use of the application diagram:

- Bearing loads:
 - top hinge: 2710 N
 - bottom hinge: 2890 N
- The following values are to be observed with all window systems:
 - width/height ratio $Q_{B/H^2} \leq 1,5$
 - sash size $H_{max} \leq 3 \text{ m}^2$
 - glass deduction dim. CG: $\geq 28 \text{ mm}$
 - profile weight PG: $\leq 3,25 \text{ kg/m}$

The application diagrams are generated according to IFT guidelines.

RC2 security is a system test meaning, that ARX as a hardware producer can only give recommendations for hardware assembled into finished product (window). ARX can't guarantee that the test will be positive solely on the base of hardware recommendations.

T&Ti RC 2 | FACE-FIT HINGE SIDE

Centered / variable handle height

1 T&T ESPAGNOLETTE M BS 14,5 mm

Sash rebate height	Handle height	Length	Material
420-660 ¹⁾	210-330	380	1083117
600-1000	300-500	720	1 RS 1101035
900-1400	450-700	1120	1 RS 1101036
1401-1800	701-900	1520	1 RS 1101037
1601-2000	801-1000	1720	2 RS 1101038
2001-2400	1001-1200	2120	2 RS 1101039

2 CORNER DRIVE - TOP

STANDARD CORNER DRIVE 2 RS 1100984

3 SASH STAY GUIDE

Sash rebate width	Type / length	Material Nr.
410-610	250 / 470	1083038
611-810	350 / 670	1083039
811-1010	500 / 870	1 RS 1100978
1011-1210	500 / 1070	1 RS 1100980
1211-1400	500 / 1270	1 RS 1100981

4 STAY ARM

ONLY SYSTEM 12/20-13

Sash rebate width	Type / length	Pos.	Material
410-610	250	L	1083016
		R	1083017
611-810	350	L	1083018
		R	1083019
811-1400	500	L	1083020
		R	1083021

5 SECURITY CORNER LOCK

SECURITY CORNER LOCK 180 mm 1 RS 1100987

6 CENTER LOCK - VERTICAL

Sash rebate height	Length	Material
420-600	200 1 RS	1101005
601-800	400 1 RS	1101006
801-1000	600 1 RS	1101012
1001-1200	400 EX 1 RS + 400 1 RS	1101016 + 1101006
1201-1400	600 EX 1 RS + 400 1 RS	1101017 + 1101006
1401-1600	600 EX 1 RS + 600 1 RS	1101017 + 1101012
1601-1800	2x 600 EX 1 RS + 200 1 RS	2x 1101017 + 1101005
1801-2000	2x 600 EX 1 RS + 400 1 RS	2x 1101017 + 1101006
2001-2400	2x 600 EX 1 RS + 600 1 RS	2x 1101017 + 1101012

7 CENTER LOCK - HORIZONTAL

Sash rebate width	Length	Material
410-540	200 1 RS	1101005
541-740	400 1 RS	1101006
741-940	600 1 RS	1101012
941-1140	400 EX 1 RS + 400 1 RS	1101016 + 1101006
1141-1340	600 EX 1 RS + 400 1 RS	1101017 + 1101006
1341-1400	600 EX 1 RS + 600 1 RS	1101017 + 1101012

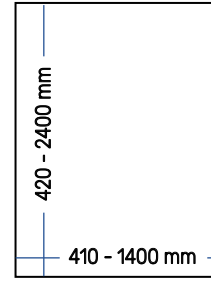
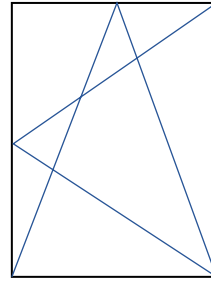

8 CORNER DRIVE - BOTTOM

STANDARD CORNER DRIVE 2 RS 1100984

9 STAY BEARING

STAY BEARING WITH PIN K6 1105598

10 CORNER HINGE

CORNER HINGE K6 1083242

11 CORNER PIVOT REST

CORNER PIVOT REST K6 1105596

12 MISHANDLING DEVICE

SASH PART 1093907
FRAME PART PAGE 141

13 STRIKERS

T&Ti STRIKER PAGE 137
SECURITY STRIKER PAGE 140

14 GROOVE SPACER

GROOVE SPACER 12 mm 1127521

15 COVER CAPS

STAY BEARING PAGE 134
STAY ARM PAGE 134
CORNER HINGE PAGE 134
CORNER PIVOT REST PAGE 134
CORNER PIVOT REST - FLAT PAGE 134

16 ARX HANDLE

ARX HANDLE - lockable PAGE 175

17 DRILLING PROTECTION

DRILLING PROTECTION RC2 1112748

* drilling protection is necessary

* lockable handle is necessary

* groove spacers are necessary

* SRH < 500 mm, move the anti-slam device to reduce the tilt

¹⁾ MISHANDLING DEVICE NOT AVAILABLE

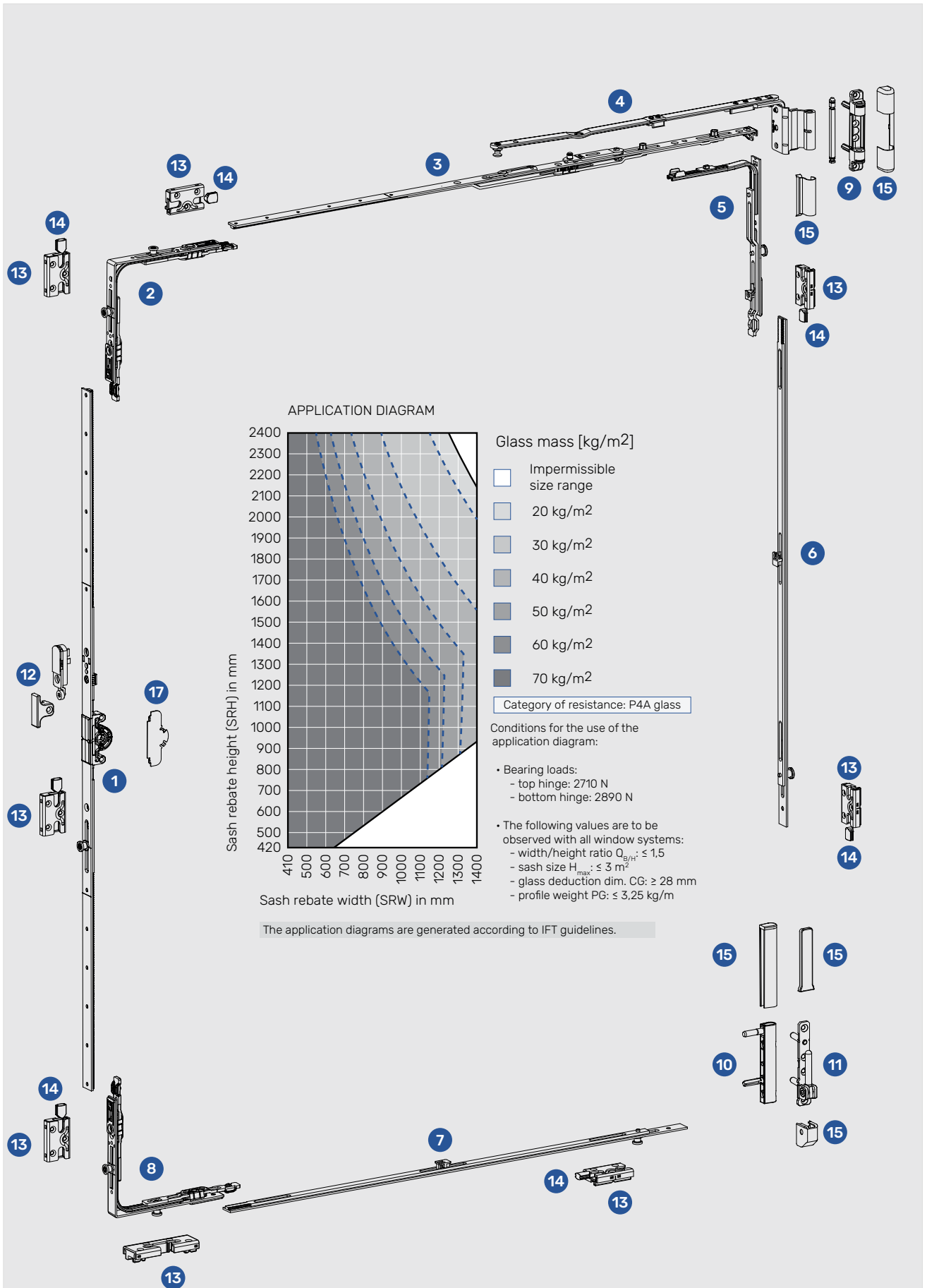

RC2 security is a system test meaning, that ARX as a hardware producer can only give recommendations for hardware assembled into finished product (window). ARX can't guarantee that the test will be positive solely on the base of hardware recommendations.

T&TI | CONCEALED HINGE SIDE

Fixed handle height

1 T&T KV ESPAGNOLETTE BS 14,5 mm

Sash rebate height	Handle height	Length	Material
320-460 ¹⁾²⁾	120	320	1105430
461-600 ³⁾	170	410	1118431
601-800	263	520	1115131
801-1000	413	720	1115132
801-1000	413	720	1 R 1115133
1001-1200	513	920	1 R 1115134
1201-1400	563	1120	1 R 1115135
1401-1600	563	1320	1 R 1115136
1601-1800	563	1520	1 R 1115137
1601-1800	1000	1520	1 R 1115167
1801-2000	1000	1720	2 R 1115138
2001-2200	1000	1920	2 R 1115139
2201-2400	1000	2120	2 R 1115140

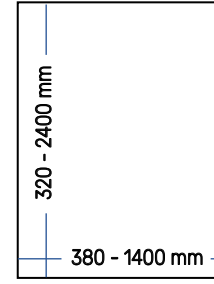
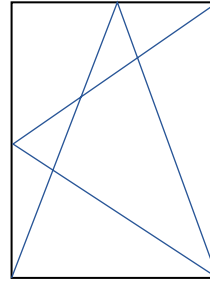

2 CORNER DRIVE - TOP

STANDARD CORNER DRIVE	1 R	1103158
SHORT CORNER DRIVE	1 R	1103162

3 SASH STAY GUIDE

SASH STAY GUIDE CONCEALED ⁴⁾⁵⁾

PAGE 127

4 STAY ARM

STAY ARM CONCEALED 12/20-13 ⁵⁾

PAGE 128

5 CENTER LOCK - VERTICAL

Sash rebate height	Length	Material
801-1200	500 / 550	2 R 1083058
1201-1700	800 / 850	2 R 1083059
1701-2100	1500 / 1550	3 R 1083060
2101-2400	1950 / 2000	4 R 1083064

6 CENTER LOCK - HORIZONTAL

Sash rebate width	Length	Material
801-1200	400	1 R 1083061
1201-1400	600	1 R 1083062

7 CORNER DRIVE - BOTTOM

STANDARD CORNER DRIVE	1 RS	1100983
SHORT CORNER DRIVE	1 RS	1100986

8 CORNER HINGE

CORNER HINGE CONCEALED	1136163
------------------------	---------

9 CORNER PIVOT

CORNER PIVOT CONCEALED ⁵⁾	PAGE 130
--------------------------------------	----------

10 MISHANDLING DEVICE

SASH PART	1093907
FRAME PART	PAGE 141

11 STRIKERS

T&Ti STRIKER	PAGE 137
STRIKER	PAGE 139

12 SASH TURN LIMITER

SASH TURN LIMITER CONCEALED ⁵⁾	1136166
---	---------

13 PACKERS

STAY ARM	PAGE 131
CORNER PIVOT	PAGE 131
TURN LIMITER	PAGE 131

¹⁾ WITH INTEGRATED CORNER DRIVE 1 RS ON BOTTOM

²⁾ MISHANDLING DEVICE NOT AVAILABLE

³⁾ MUST USE SHORT CORNER DRIVE 1100986 ON BOTTOM

⁴⁾ SRW = 380 - 470 mm, WITH SHORT CORNER DRIVE ON TOP

⁵⁾ WITHOUT PACKERS - SEE **13**

* SRH < 500 mm, move the anti-slam device to reduce the tilt

* **5** special range of use because of corner hinge

APPLICATION DIAGRAM

Sash rebate height (SRH) in mm

Sash rebate width (SRW) in mm

Glass mass [kg/m²]

- Impermissible size range
- 20 kg/m²
- 30 kg/m²
- 40 kg/m²
- 50 kg/m²
- 60 kg/m²
- 70 kg/m²

Conditions for the use of the application diagram:

- Bearing loads:
 - top hinge: 2200 N
 - bottom hinge: 2310 N
- The following values are to be observed with all window systems:
 - width/height ratio $Q_{g/h} \leq 1.5$
 - sash size $H_{max} \leq 3 \text{ m}^2$
 - glass deduction dim. CG: $\geq 28 \text{ mm}$
 - profile weight PG: $\leq 3.25 \text{ kg/m}$

The application diagrams are generated according to IFT guidelines.

T&TI | CONCEALED HINGE SIDE

Centered / variable handle height

1 T&T ESPAGNOLETTE M BS 14,5 mm

Sash rebate height	Handle height	Length	Material
420-660 ¹⁾	210-330	380	1083117
600-1000	300-500	720	1 R 1088473
900-1400	450-700	1120	1 R 1098964
1401-1800	701-900	1520	1 R 1098965
1601-2000	801-1000	1720	2 R 1098966
2001-2400	1001-1200	2120	2 R 1098967

2 CORNER DRIVE - TOP

STANDARD CORNER DRIVE	1 R	1103158
SHORT CORNER DRIVE	1 R	1103162

3 SASH STAY GUIDE

SASH STAY GUIDE CONCEALED ²⁾ [PAGE 127](#)

4 STAY ARM

STAY ARM CONCEALED 12/20-13 ³⁾ [PAGE 128](#)

5 CENTER LOCK - VERTICAL

Sash rebate height	Length	Material
801-1200	500 / 550	2 R 1083058
1201-1700	800 / 850	2 R 1083059
1701-2100	1500 / 1550	3 R 1083060
2101-2400	1950 / 2000	4 R 1083064

6 CENTER LOCK - HORIZONTAL

Sash rebate width	Length	Material
801-1200	400	1 R 1083061
1201-1400	600	1 R 1083062

7 CORNER DRIVE - BOTTOM

STANDARD CORNER DRIVE	1 RS	1100983
-----------------------	------	---------

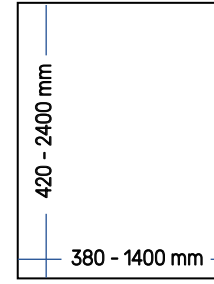
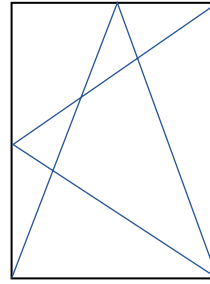

380 - 1400 mm



8 CORNER HINGE

CORNER HINGE CONCEALED 1136163

9 CORNER PIVOT

CORNER PIVOT CONCEALED ³⁾ [PAGE 130](#)

10 MISHANDLING DEVICE

SASH PART 1093907
FRAME PART [PAGE 141](#)

11 STRIKERS

T&TI STRIKER [PAGE 137](#)
STRIKER [PAGE 139](#)

12 SASH TURN LIMITER

SASH TURN LIMITER CONCEALED ³⁾ 1136166

13 PACKERS

STAY ARM [PAGE 131](#)
CORNER PIVOT [PAGE 131](#)
TURN LIMITER [PAGE 131](#)

¹⁾ MISHANDLING DEVICE NOT AVAILABLE

²⁾ SRW = 380 - 470 mm, WITH SHORT CORNER DRIVE ON TOP

³⁾ WITHOUT PACKERS - SEE [13](#)

* SRH < 500 mm, move the anti-slam device to reduce the tilt

* [5](#) special range of use because of corner hinge

APPLICATION DIAGRAM

Sash rebate height (SRH) in mm

Sash rebate width (SRW) in mm

Glass mass [kg/m²]

- Impermissible size range
- 20 kg/m²
- 30 kg/m²
- 40 kg/m²
- 50 kg/m²
- 60 kg/m²
- 70 kg/m²

Conditions for the use of the application diagram:

- Bearing loads:
 - top hinge: 2200 N
 - bottom hinge: 2310 N
- The following values are to be observed with all window systems:
 - width/height ratio $Q_{SRH} \leq 1,5$
 - sash size $H_{max} \leq 3 \text{ m}^2$
 - glass deduction dim. CG: $\geq 28 \text{ mm}$
 - profile weight PG: $\leq 3,25 \text{ kg/m}$

The application diagrams are generated according to IFT guidelines.

T&T | CONCEALED HINGE SIDE

Fixed handle height

1 T&T KV ESPAGNOLETTE BS 14,5 mm

Sash rebate height	Handle height	Length	Material
550-600	260	410	1118431
601-800	263	520	1115131
801-1000	413	720	1115132
801-1000	413	720	1 R 1115133
1001-1200	513	920	1 R 1115134
1201-1400	563	1120	1 R 1115135
1401-1600	563	1320	1 R 1115136
1601-1800	563	1520	1 R 1115137
1601-1800	1000	1520	1 R 1115167
1801-2000	1000	1720	2 R 1115138
2001-2200	1000	1920	2 R 1115139
2201-2400	1000	2120	2 R 1115140

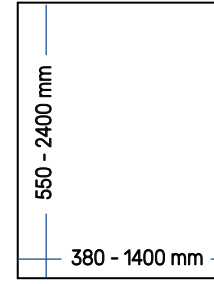
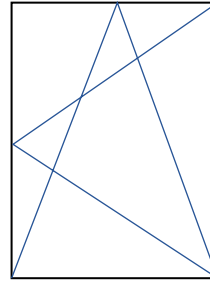

2 CORNER DRIVE

STANDARD CORNER DRIVE	1 R	1103158
SHORT CORNER DRIVE	1 R	1103162

3 SASH STAY GUIDE

SASH STAY GUIDE CONCEALED ^{1) 2)}	PAGE 127
--	----------

4 STAY ARM

STAY ARM CONCEALED 12/20-13 ²⁾	PAGE 128
---	----------

5 CENTER LOCK - VERTICAL

Sash rebate height	Length	Material
801-1200	500 / 550	2 R 1083058
1201-1700	800 / 850	2 R 1083059
1701-2100	1500 / 1550	3 R 1083060
2101-2400	1950 / 2000	4 R 1083064

6 CENTER LOCK - HORIZONTAL

Sash rebate width	Length	Material
801-1200	500 / 550	2 R 1083058
1201-1400	800 / 850	2 R 1083059

7 TILT LOCK BOLT

TILT LOCK BOLT SRH < 1000 mm	1102388
TILT LOCK BOLT SRH > 1001 mm	1102391

8 CORNER HINGE

CORNER HINGE CONCEALED	1136163
------------------------	---------

9 CORNER PIVOT

CORNER PIVOT CONCEALED ²⁾	PAGE 130
--------------------------------------	----------

10 MISHANDLING DEVICE

SASH PART	1093907
FRAME PART	PAGE 141

11 STRIKERS

T&T STRIKER	PAGE 136
STRIKER	PAGE 139

12 SASH TURN LIMITER

SASH TURN LIMITER CONCEALED ²⁾	1136166
---	---------

13 PACKERS

STAY ARM	PAGE 131
CORNER PIVOT	PAGE 131
TURN LIMITER	PAGE 131

¹⁾ SRW = 380 - 470 mm, WITH SHORT CORNER DRIVE ON TOP

²⁾ WITHOUT PACKERS - SEE **13**

* SRH < 500 mm, move the anti-slam device to reduce the tilt

* **5** special range of use because of corner hinge

APPLICATION DIAGRAM

Sash rebate height (SRH) in mm

Sash rebate width (SRW) in mm

Glass mass [kg/m²]

- Impermissible size range
- 20 kg/m²
- 30 kg/m²
- 40 kg/m²
- 50 kg/m²
- 60 kg/m²
- 70 kg/m²

Conditions for the use of the application diagram:

- Bearing loads:
 - top hinge: 2200 N
 - bottom hinge: 2310 N
- The following values are to be observed with all window systems:
 - width/height ratio $Q_{g/h} \leq 1,5$
 - sash size $H_{max} \leq 3 \text{ m}^2$
 - glass deduction dim. CG: $\geq 28 \text{ mm}$
 - profile weight PG: $\leq 3,25 \text{ kg/m}$

The application diagrams are generated according to IFT guidelines.

T&T | CONCEALED HINGE SIDE

Centered / variable handle height

1 T&T ESPAGNOLETTE M BS 14,5 mm

Sash rebate height	Handle height	Length	Material
420-660 ¹⁾	210-330	380	1083117
600-1000	300-500	720	1 R 1088473
900-1400	450-700	1120	1 R 1098964
1401-1800	701-900	1520	1 R 1098965
1601-2000	801-1000	1720	2 R 1098966
2001-2400	1001-1200	2120	2 R 1098967

2 CORNER DRIVE

STANDARD CORNER DRIVE	1 R	1103158
SHORT CORNER DRIVE	1 R	1103162

3 SASH STAY GUIDE

SASH STAY GUIDE CONCEALED ²⁾ ³⁾ [PAGE 127](#)

4 STAY ARM

STAY ARM CONCEALED 12/20-13 ³⁾ [PAGE 128](#)

5 CENTER LOCK - VERTICAL

Sash rebate height	Length	Material
801-1200	500 / 550	2 R 1083058
1201-1700	800 / 850	2 R 1083059
1701-2100	1500 / 1550	3 R 1083060
2101-2400	1950 / 2000	4 R 1083064

6 CENTER LOCK - HORIZONTAL

Sash rebate width	Length	Material
801-1200	500 / 550	2 R 1083058
1201-1400	800 / 850	2 R 1083059

7 TILT LOCK BOLT

TILT LOCK BOLT SRH < 1000 mm	1102388
TILT LOCK BOLT SRH > 1001 mm	1102391

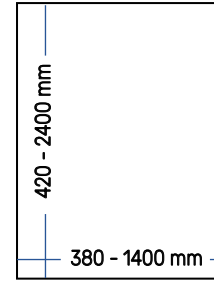
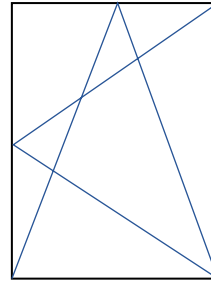

8 CORNER HINGE

CORNER HINGE CONCEALED 1136163

9 CORNER PIVOT

CORNER PIVOT CONCEALED ³⁾ [PAGE 130](#)

10 MISHANDLING DEVICE

SASH PART 1093907
FRAME PART [PAGE 141](#)

11 STRIKERS

T&T STRIKER [PAGE 136](#)
STRIKER [PAGE 139](#)

12 SASH TURN LIMITER

SASH TURN LIMITER CONCEALED ³⁾ 1136166

13 PACKERS

STAY ARM [PAGE 131](#)
CORNER PIVOT [PAGE 131](#)
TURN LIMITER [PAGE 131](#)

¹⁾ MISHANDLING DEVICE NOT AVAILABLE

²⁾ SRW = 380 - 470 mm, WITH SHORT CORNER DRIVE ON TOP

³⁾ WITHOUT PACKERS - SEE [13](#)

* SRH < 500 mm, move the anti-slam device to reduce the tilt

* [5](#) special range of use because of corner hinge

APPLICATION DIAGRAM

Sash rebate height (SRH) in mm

Sash rebate width (SRW) in mm

Glass mass [kg/m²]

- Impermissible size range
- 20 kg/m²
- 30 kg/m²
- 40 kg/m²
- 50 kg/m²
- 60 kg/m²
- 70 kg/m²

Conditions for the use of the application diagram:

- Bearing loads:
 - top hinge: 2200 N
 - bottom hinge: 2310 N
- The following values are to be observed with all window systems:
 - width/height ratio $Q_{\text{B}/\text{H}} \leq 1,5$
 - sash size $H_{\text{max}} \leq 3 \text{ m}^2$
 - glass deduction dim. CG: $\geq 28 \text{ mm}$
 - profile weight PG: $\leq 3,25 \text{ kg/m}$

The application diagrams are generated according to IFT guidelines.

TURN - BASIC | FACE-FIT HINGE SIDE

Fixed handle height

1 ESPAGNOLETTE BS 14,5 mm

Sash rebate height	Handle height	Length	Material
400-500 ¹⁾	170	500	2 R 1083129
501-600	170	600	2 R 1083130
601-700	263	700	2 R 1083131
701-800	263	800	2 R 1083132
801-900	413	900	2 R 1083133
901-1000	413	1000	2 R 1083134
1001-1100	513	1100	3 R 1083135
1101-1200	513	1200	3 R 1083136
1201-1300	563	1300	3 R 1083137
1301-1400	563	1400	3 R 1083138
1401-1500	563	1500	3 R 1083139
1501-1600	563	1600	3 R 1083140
1601-1700	563	1700	3 R 1083141
1701-1800	563	1800	4 R 1083142
1800-2000	1000	2000	4 R 1083143
2001-2200	1000	2200	4 R 1083144
2201-2400	1000	2400	4 R 1083145

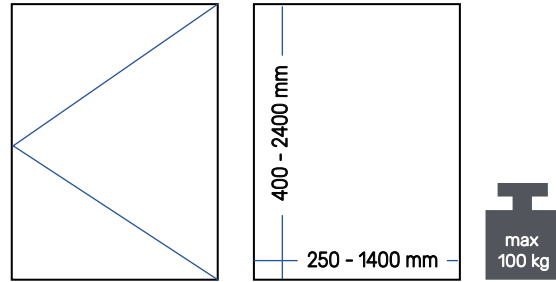

2 REBATE STAY ARM

REBATE STAY ARM 12/20-13	L	1083263
REBATE STAY ARM 12/20-13	R	1083262

3 STAY BEARING

STAY BEARING WITH PIN K3	1083250
--------------------------	---------

4 CORNER HINGE

CORNER HINGE K3	1083241
-----------------	---------

5 CORNER PIVOT REST

CORNER PIVOT REST K3	1083247
----------------------	---------

6 MISHANDLING DEVICE

SASH PART	1093907
FRAME PART	PAGE 141

7 STRIKERS

STRIKER	PAGE 139
---------	----------

8 CONCEALED STRIKER

SASH PART	1127509
FRAME PART	PAGE 140

9 COVER CAPS

STAY BEARING	PAGE 134
REBATE STAY ARM / STAY ARM	PAGE 134
CORNER HINGE	PAGE 134
CORNER PIVOT REST	PAGE 134
CORNER PIVOT REST - FLAT	PAGE 134

¹⁾ MISHANDLING DEVICE NOT AVAILABLE

* mishandling device serves as a sash lifter

* for SRW > 800 mm, next scheme (STANDARD) is recommended

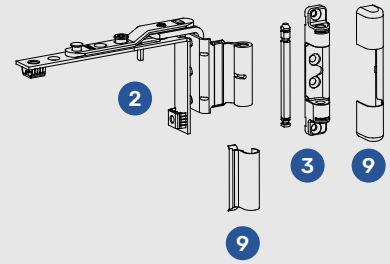
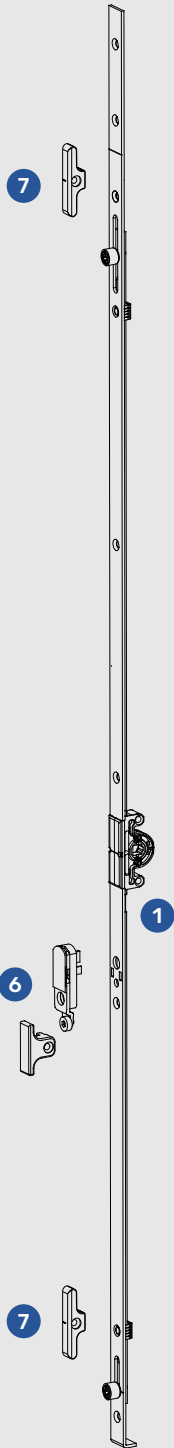

APPLICATION DIAGRAM

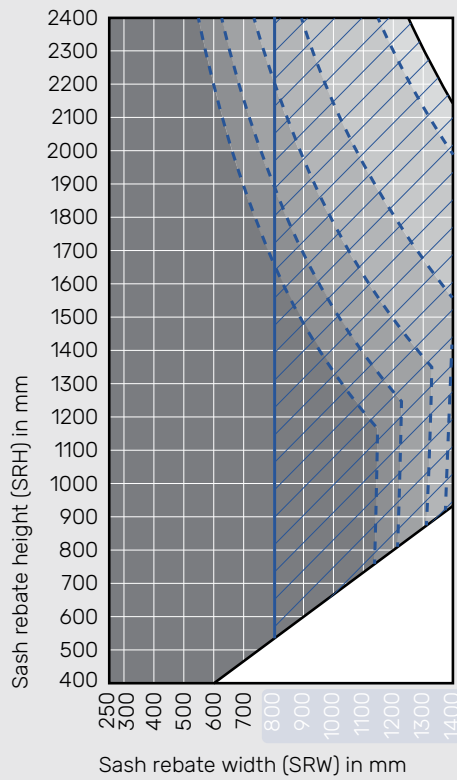

Glass mass [kg/m²]

- Impermissible size range
- 20 kg/m²
- 30 kg/m²
- 40 kg/m²
- 50 kg/m²
- 60 kg/m²
- 70 kg/m²

Conditions for the use of the application diagram:

- Bearing loads:
 - top hinge: 2710 N
 - bottom hinge: 2890 N
- The following values are to be observed with all window systems:
 - width/height ratio $Q_{b/h}$: $\leq 1,5$
 - sash size H_{max} : $\leq 3 \text{ m}^2$
 - glass deduction dim. CG: $\geq 28 \text{ mm}$
 - profile weight PG: $\leq 3,25 \text{ kg/m}$

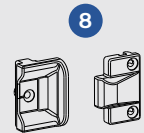

The application diagrams are generated according to IFT guidelines.

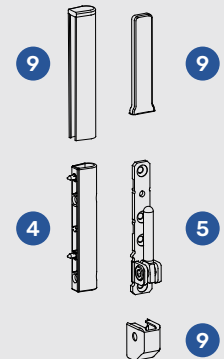

TURN - STANDARD | FACE-FIT HINGE SIDE

Fixed handle height

1 KV ESPAGNOLETTE BS 14,5 mm

Sash rebate height	Handle height	Lenght	Material
550-600	260	410	1118431
601-800	263	520	1115131
801-1000	413	720	1115132
801-1000	413	720	1 R 1115133
1001-1200	513	920	1 R 1115134
1201-1400	563	1120	1 R 1115135
1401-1600	563	1320	1 R 1115136
1601-1800	563	1520	1 R 1115137
1601-1800	1000	1520	1 R 1115167
1801-2000	1000	1720	2 R 1115138
2001-2200	1000	1920	2 R 1115139
2201-2400	1000	2120	2 R 1115140

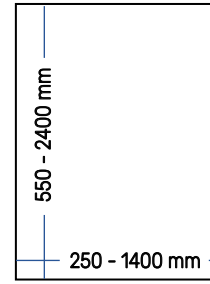
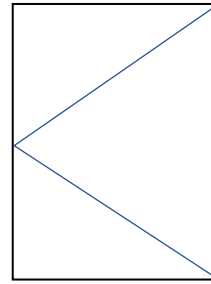

2 LOCK BOLT - BOTTOM

LOCK BOLT 140 1 R 1102394

3 LOCK BOLT - TOP

LOCK BOLT 140/90 1 R 1102395

4 CENTER LOCK

Sash rebate width	Lenght	Material
801-1200	500 / 550	2 R 1083058
1201-1400	800 / 850	2 R 1083059

5 REBATE STAY ARM

REBATE STAY ARM 12/20-13 L 1083263
REBATE STAY ARM 12/20-13 R 1083262

6 STAY BEARING

STAY BEARING WITH PIN K3 1083250

7 CORNER HINGE

CORNER HINGE K3 1083241

8 CORNER PIVOT REST

CORNER PIVOT REST K3 1083247

9 MISHANDLING DEVICE

SASH PART 1093907
FRAME PART PAGE 141

10 STRIKERS

STRIKER PAGE 139

11 CONCEALED STRIKER

SASH PART 1127509
FRAME PART PAGE 140

12 COVER CAPS

STAY BEARING PAGE 134
REBATE STAY ARM / STAY ARM PAGE 134
CORNER HINGE PAGE 134
CORNER PIVOT REST PAGE 134
CORNER PIVOT REST - FLAT PAGE 134

* mishandling device serves as a sash lifter

APPLICATION DIAGRAM

Sash rebate height (SRH) in mm

Sash rebate width (SRW) in mm

Glass mass [kg/m²]

- Impermissible size range
- 20 kg/m²
- 30 kg/m²
- 40 kg/m²
- 50 kg/m²
- 60 kg/m²
- 70 kg/m²

Conditions for the use of the application diagram:

- Bearing loads:
 - top hinge: 2710 N
 - bottom hinge: 2890 N
- The following values are to be observed with all window systems:
 - width/height ratio $Q_{g/H}$: $\leq 1,5$
 - sash size H_{max} : $\leq 3 \text{ m}^2$
 - glass deduction dim. CG: $\geq 28 \text{ mm}$
 - profile weight PG: $\leq 3,25 \text{ kg/m}$

The application diagrams are generated according to IFT guidelines.

TURN - BASIC | FACE-FIT HINGE SIDE

Centered / variable handle height

1 ESPAGNOLETTE M BS 14,5 mm

Sash rebate height	Handle height	Length	Material	
180-250 ¹⁾	90-125	180	1 R	1083163
251-500 ¹⁾	126-250	500	1 R	1083164
501-900	251-450	900	2 R	1083165
901-1400	451-700	1400	3 R	1083166
1401-1900	701-950	1900	4 R	1083167
1901-2400	951-1200	2400	4 R	1083168

2 REBATE STAY ARM

REBATE STAY ARM 12/20-13	L	1083263
REBATE STAY ARM 12/20-13	R	1083262

3 STAY BEARING

STAY BEARING WITH PIN K3		1083250
--------------------------	--	---------

4 CORNER HINGE

CORNER HINGE K3		1083241
-----------------	--	---------

5 CORNER PIVOT REST

CORNER PIVOT REST K3		1083247
----------------------	--	---------

6 MISHANDLING DEVICE

SASH PART		1093907
FRAME PART		PAGE 141

7 STRIKERS

STRIKER		PAGE 139
---------	--	----------

8 CONCEALED STRIKER

SASH PART		1127509
FRAME PART		PAGE 140

9 COVER CAPS

STAY BEARING		PAGE 134
REBATE STAY ARM / STAY ARM		PAGE 134
CORNER HINGE		PAGE 134
CORNER PIVOT REST		PAGE 134
CORNER PIVOT REST - FLAT		PAGE 134

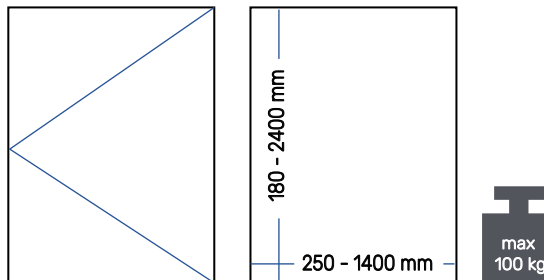

¹⁾ MISHANDLING DEVICE NOT AVAILABLE

* mishandling device serves as a sash lifter

* for SRW > 800 mm, next scheme (STANDARD) is recommended

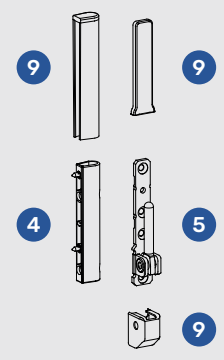
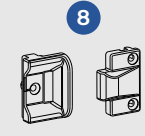
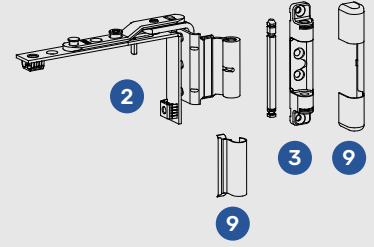
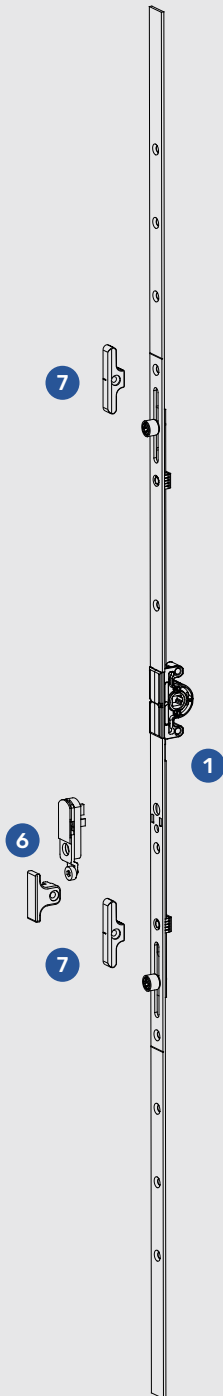

APPLICATION DIAGRAM

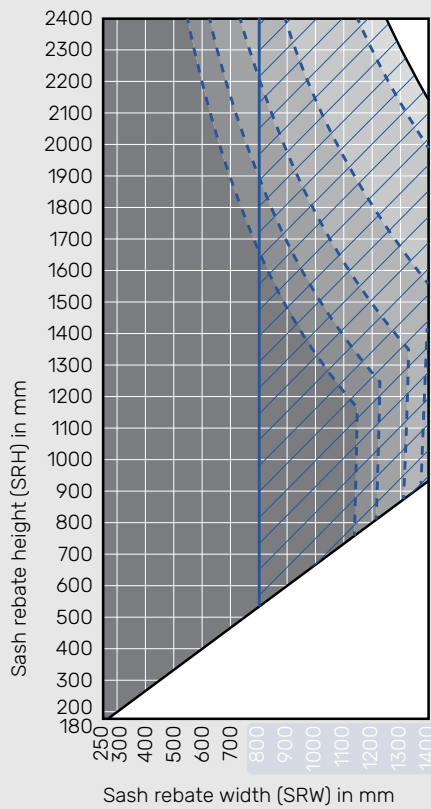

Glass mass [kg/m²]

- Impermissible size range
- 20 kg/m²
- 30 kg/m²
- 40 kg/m²
- 50 kg/m²
- 60 kg/m²
- 70 kg/m²

Conditions for the use of the application diagram:

- Bearing loads:
 - top hinge: 2710 N
 - bottom hinge: 2890 N
- The following values are to be observed with all window systems:
 - width/height ratio $Q_{B/H} \leq 1,5$
 - sash size $H_{max} \leq 3 \text{ m}^2$
 - glass deduction dim. CG: $\geq 28 \text{ mm}$
 - profile weight PG: $\leq 3,25 \text{ kg/m}$

The application diagrams are generated according to IFT guidelines.

TURN - STANDARD | FACE-FIT HINGE SIDE

Centered / variable handle height

1 T&T ESPAGNOLETTE M BS 14,5 mm

Sash rebate height	Handle height	Lenght	Material
420-660 ¹⁾	210-330	380	1083117
601-1000	300-500	720	1 R 1088473
900-1400	450-700	1120	1 R 1098964
1401-1800	701-900	1520	1 R 1098965
1601-2000	801-1000	1720	2 R 1098966
2001-2400	1001-1200	2120	2 R 1098967

2 LOCK BOLT - BOTTOM

LOCK BOLT 140 1 R 1102394

3 LOCK BOLT - TOP

LOCK BOLT 140/90 1 R 1102395

4 CENTER LOCK

Sash rebate width	Lenght	Material
801-1200	500 / 550	2 R 1083058
1201-1400	800 / 850	2 R 1083059

5 REBATE STAY ARM

REBATE STAY ARM 12/20-13 L 1083263
REBATE STAY ARM 12/20-13 R 1083262

6 STAY BEARING

STAY BEARING WITH PIN K3 1083250

7 CORNER HINGE

CORNER HINGE K3 1083241

8 CORNER PIVOT REST

CORNER PIVOT REST K3 1083247

9 MISHANDLING DEVICE

SASH PART 1093907
FRAME PART [PAGE 141](#)

10 STRIKERS

STRIKER [PAGE 139](#)

11 CONCEALED STRIKER

SASH PART 1127509
FRAME PART [PAGE 140](#)

12 COVER CAPS

STAY BEARING [PAGE 134](#)
REBATE STAY ARM / STAY ARM [PAGE 134](#)
CORNER HINGE [PAGE 134](#)
CORNER PIVOT REST [PAGE 134](#)
CORNER PIVOT REST - FLAT [PAGE 134](#)

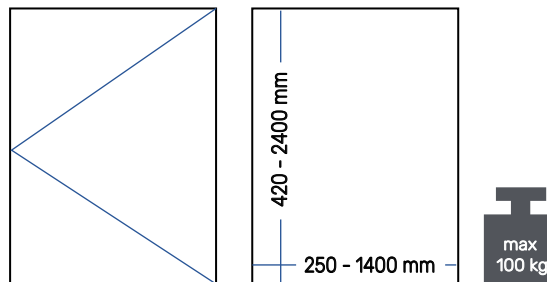

¹⁾ MISHANDLING DEVICE NOT AVAILABLE

* mishandling device serves as a sash lifter

APPLICATION DIAGRAM

Sash rebate height (SRH) in mm

Sash rebate width (SRW) in mm

Glass mass [kg/m²]

- Impermissible size range
- 20 kg/m²
- 30 kg/m²
- 40 kg/m²
- 50 kg/m²
- 60 kg/m²
- 70 kg/m²

Conditions for the use of the application diagram:

- Bearing loads:
 - top hinge: 2710 N
 - bottom hinge: 2890 N
- The following values are to be observed with all window systems:
 - width/height ratio $Q_{B/H}$: $\leq 1,5$
 - sash size H_{max} : $\leq 3 \text{ m}^2$
 - glass deduction dim. CG: $\geq 28 \text{ mm}$
 - profile weight PG: $\leq 3,25 \text{ kg/m}$

The application diagrams are generated according to IFT guidelines.

TURN - BASIC | CONCEALED HINGE SIDE

Fixed handle height

1 ESPAGNOLETTE BS 14,5 mm

Sash rebate height	Handle height	Length	Material
400-500 ¹⁾	170	500	2 R 1083129
501-600	170	600	2 R 1083130
601-700	263	700	2 R 1083131
701-800	263	800	2 R 1083132
801-900	413	900	2 R 1083133
901-1000	413	1000	2 R 1083134
1001-1100	513	1100	3 R 1083135
1101-1200	513	1200	3 R 1083136
1201-1300	563	1300	3 R 1083137
1301-1400	563	1400	3 R 1083138
1401-1500	563	1500	3 R 1083139
1501-1600	563	1600	3 R 1083140
1601-1700	563	1700	3 R 1083141
1701-1800	563	1800	4 R 1083142
1800-2000	1000	2000	4 R 1083143
2001-2200	1000	2200	4 R 1083144
2201-2400	1000	2400	4 R 1083145

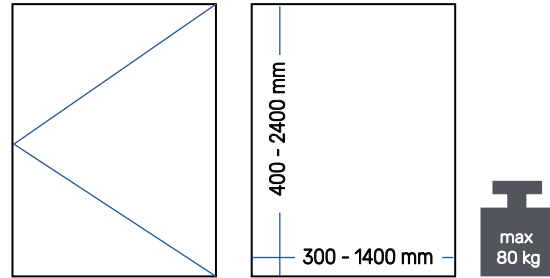

2 REBATE STAY ARM

REBATE STAY ARM CONCEALED 12/20-13 ²⁾

PAGE 129

3 REBATE STAY ARM GUIDE

REBATE STAY ARM GUIDE

1141516

4 CORNER HINGE

CORNER HINGE CONCEALED

1136163

5 CORNER PIVOT

CORNER PIVOT CONCEALED ²⁾

PAGE 130

6 MISHANDLING DEVICE

SASH PART
FRAME PART

1093907

PAGE 141

7 STRIKERS

STRIKER

PAGE 139

8 CONCEALED STRIKER

SASH PART
FRAME PART

1127509

PAGE 140

9 SASH TURN LIMITER

SASH TURN LIMITER CONCEALED ²⁾

1136166

10 PACKERS

REBATE STAY ARM
CORNER PIVOT
TURN LIMITER

PAGE 131

PAGE 131

PAGE 131

¹⁾ MISHANDLING DEVICE NOT AVAILABLE

²⁾ WITHOUT PACKERS - SEE **10**

* mishandling device serves as a sash lifter

* for SRW > 820 mm, next scheme (STANDARD) is recommended

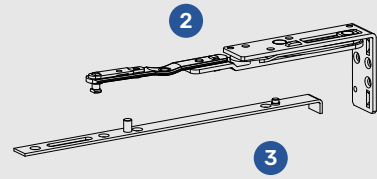
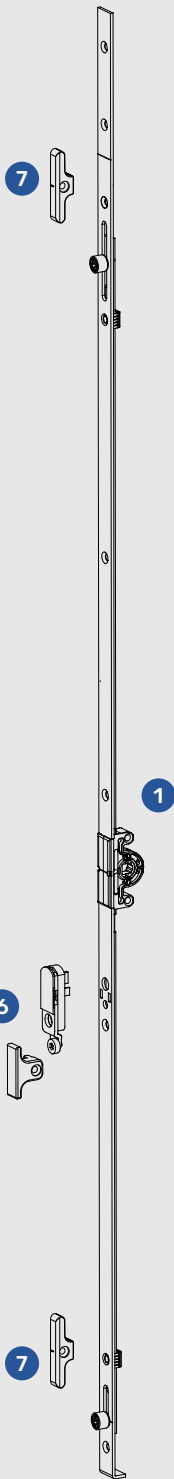

APPLICATION DIAGRAM

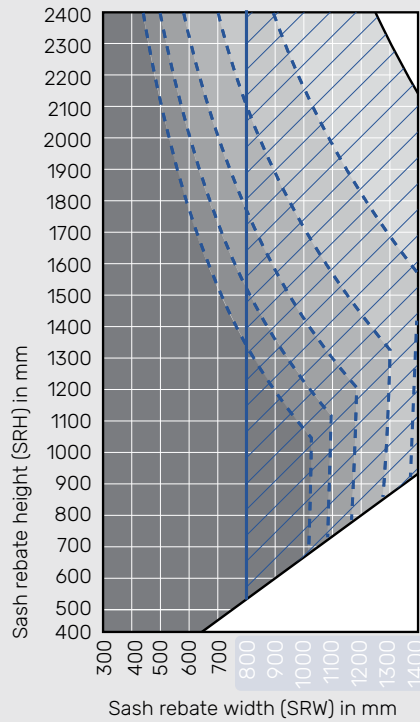

Glass mass [kg/m²]

- Impermissible size range
- 20 kg/m²
- 30 kg/m²
- 40 kg/m²
- 50 kg/m²
- 60 kg/m²
- 70 kg/m²

Conditions for the use of the application diagram:

- Bearing loads:
 - top hinge: 2200 N
 - bottom hinge: 2310 N
- The following values are to be observed with all window systems:
 - width/height ratio $Q_{B/H} \leq 1,5$
 - sash size $H_{max} \leq 3 \text{ m}^2$
 - glass deduction dim. CG: $\geq 28 \text{ mm}$
 - profile weight PG: $\leq 3,25 \text{ kg/m}$

The application diagrams are generated according to IFT guidelines.

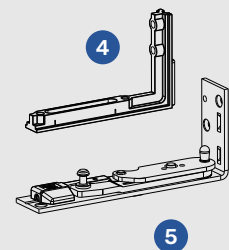
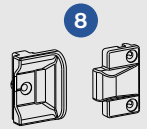

TURN - STANDARD | CONCEALED HINGE SIDE

Fixed handle height

1 KV ESPAGNOLETTE BS 14,5 mm

Sash rebate height	Handle height	Lenght	Material
550-600	260	410	1118431
601-800	263	520	1115131
801-1000	413	720	1115132
801-1000	413	720	1 R 1115133
1001-1200	513	920	1 R 1115134
1201-1400	563	1120	1 R 1115135
1401-1600	563	1320	1 R 1115136
1601-1800	563	1520	1 R 1115137
1601-1800	1000	1520	1 R 1115167
1801-2000	1000	1720	2 R 1115138
2001-2200	1000	1920	2 R 1115139
2201-2400	1000	2120	2 R 1115140

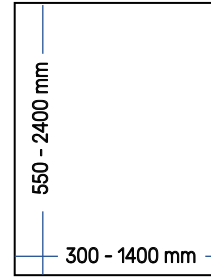
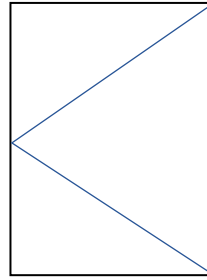

2 LOCK BOLT - BOTTOM

LOCK BOLT 140 1 R 1102394

3 LOCK BOLT - TOP

LOCK BOLT 140/90 1 R 1102395

4 CENTER LOCK

Sash rebate width	Lenght	Material
821-1200	500 / 550	2 R 1083058
1201-1400	800 / 850	2 R 1083059

5 REBATE STAY ARM

REBATE STAY ARM CONCEALED 12/20-13 ²⁾ [PAGE 129](#)

6 REBATE STAY ARM GUIDE

REBATE STAY ARM GUIDE 1141516

7 CORNER HINGE

CORNER HINGE CONCEALED 1136163

8 CORNER PIVOT

CORNER PIVOT CONCEALED ²⁾ [PAGE 130](#)

9 MISHANDLING DEVICE

SASH PART 1093907
FRAME PART [PAGE 141](#)

10 STRIKERS

STRIKER [PAGE 139](#)

11 CONCEALED STRIKER

SASH PART 1127509
FRAME PART [PAGE 140](#)

12 SASH TURN LIMITER

SASH TURN LIMITER CONCEALED ²⁾ 1136166

13 PACKERS

REBATE STAY ARM [PAGE 131](#)
CORNER PIVOT [PAGE 131](#)
TURN LIMITER [PAGE 131](#)

¹⁾ MISHANDLING DEVICE NOT AVAILABLE

²⁾ WITHOUT PACKERS - SEE **13**

* mishandling device serves as a sash lifter

APPLICATION DIAGRAM

Sash rebate height (SRH) in mm

Sash rebate width (SRW) in mm

Glass mass [kg/m²]

- Impermissible size range
- 20 kg/m²
- 30 kg/m²
- 40 kg/m²
- 50 kg/m²
- 60 kg/m²
- 70 kg/m²

Conditions for the use of the application diagram:

- Bearing loads:
 - top hinge: 2200 N
 - bottom hinge: 2310 N
- The following values are to be observed with all window systems:
 - width/height ratio $Q_{B/H} \leq 1,5$
 - sash size $H_{max} \leq 3 \text{ m}^2$
 - glass deduction dim. CG: $\geq 28 \text{ mm}$
 - profile weight PG: $\leq 3,25 \text{ kg/m}$

The application diagrams are generated according to IFT guidelines.

TURN - BASIC | CONCEALED HINGE SIDE

Centered / variable handle height

1 ESPAGNOLETTE M BS 14,5 mm

Sash rebate height	Handle height	Length	Material
180-250 ¹⁾	90-125	180	1 R 1083163
251-500 ¹⁾	126-250	500	1 R 1083164
501-900	251-450	900	2 R 1083165
901-1400	451-700	1400	3 R 1083166
1401-1900	701-950	1900	4 R 1083167
1901-2400	951-1200	2400	4 R 1083168

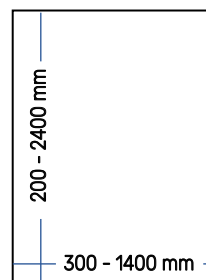
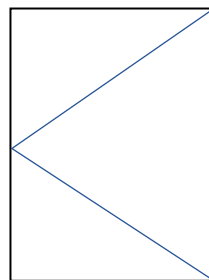

2 REBATE STAY ARM

REBATE STAY ARM CONCEALED 12/20-13 ²⁾

PAGE 129

3 REBATE STAY ARM GUIDE

REBATE STAY ARM GUIDE

1141516

4 CORNER HINGE

CORNER HINGE CONCEALED

1136163

5 CORNER PIVOT

CORNER PIVOT CONCEALED ²⁾

PAGE 130

6 MISHANDLING DEVICE

SASH PART
FRAME PART

1093907

PAGE 141

7 STRIKERS

STRIKER

PAGE 139

8 CONCEALED STRIKER

SASH PART
FRAME PART

1127509

PAGE 140

9 SASH TURN LIMITER

SASH TURN LIMITER CONCEALED ²⁾

1136166

10 PACKERS

REBATE STAY ARM
CORNER PIVOT
TURN LIMITER

PAGE 131

PAGE 131

PAGE 131

¹⁾ MISHANDLING DEVICE NOT AVAILABLE

²⁾ WITHOUT PACKERS - SEE **10**

* mishandling device serves as a sash lifter

* for SRW > 820 mm, next scheme (STANDARD) is recommended

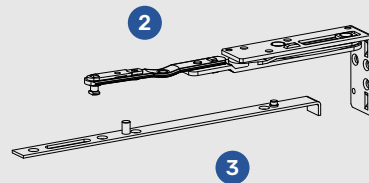
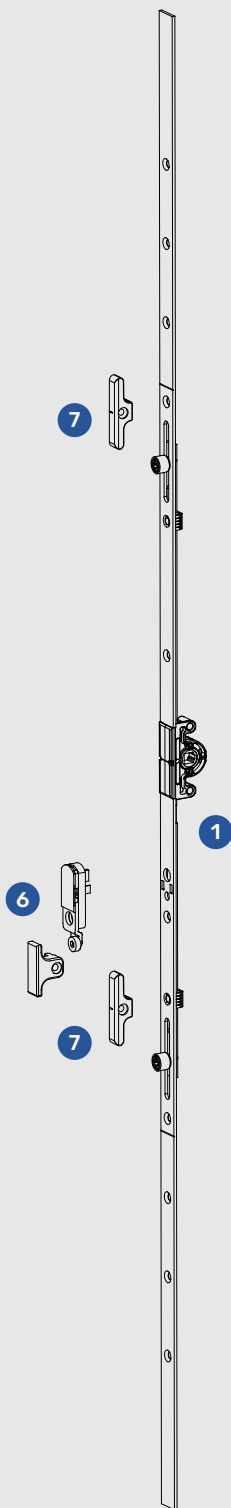

APPLICATION DIAGRAM

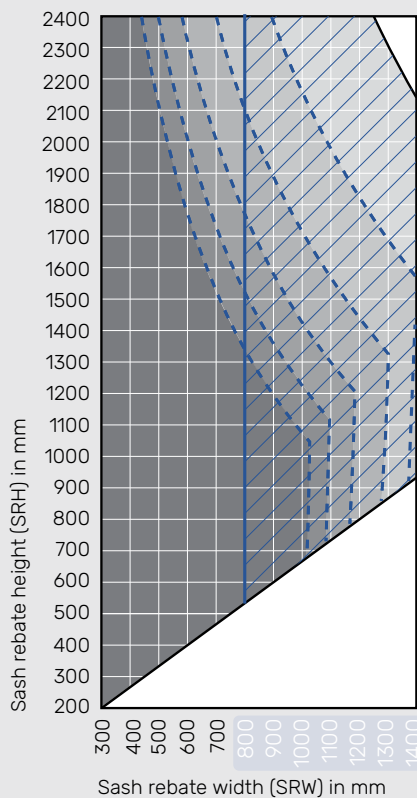

Glass mass [kg/m²]

- Impermissible size range
- 20 kg/m²
- 30 kg/m²
- 40 kg/m²
- 50 kg/m²
- 60 kg/m²
- 70 kg/m²

Conditions for the use of the application diagram:

- Bearing loads:
 - top hinge: 2200 N
 - bottom hinge: 2310 N
- The following values are to be observed with all window systems:
 - width/height ratio $Q_{B/H} \leq 1,5$
 - sash size $H_{max} \leq 3 \text{ m}^2$
 - glass deduction dim. CG: $\geq 28 \text{ mm}$
 - profile weight PG: $\leq 3,25 \text{ kg/m}$

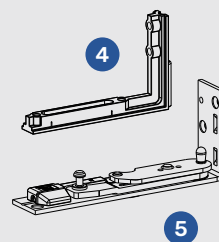
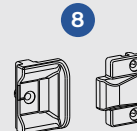

The application diagrams are generated according to IFT guidelines.

TURN - STANDARD | CONCEALED HINGE SIDE

Centered / variable handle height

1 T&T ESPAGNOLETTE M BS 14,5 mm

Sash rebate height	Handle height	Lenght	Material
420-660 ¹⁾	210-330	380	1083117
601-1000	300-500	720	1 R 1088473
900-1400	450-700	1120	1 R 1098964
1401-1800	701-900	1520	1 R 1098965
1601-200	801-1000	1720	2 R 1098966
2001-2400	1001-1200	2120	2 R 1098967

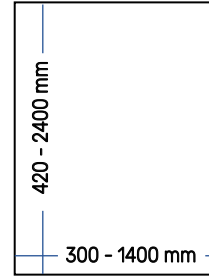
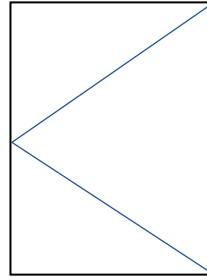

2 LOCK BOLT - BOTTOM

LOCK BOLT 140 1 R 1102394

3 LOCK BOLT - TOP

LOCK BOLT 140/90 1 R 1102395

4 CENTER LOCK

Sash rebate width	Lenght	Material
821-1200	500 / 550	2 R 1083058
1201-1400	800 / 850	2 R 1083059

5 REBATE STAY ARM

REBATE STAY ARM CONCEALED 12/20-13 ²⁾ PAGE 129

6 REBATE STAY ARM GUIDE

REBATE STAY ARM GUIDE 1141516

7 CORNER HINGE

CORNER HINGE CONCEALED 1136163

8 CORNER PIVOT

CORNER PIVOT CONCEALED ²⁾ PAGE 130

9 MISHANDLING DEVICE

SASH PART 1093907
FRAME PART PAGE 141

10 STRIKERS

STRIKER PAGE 139

11 CONCEALED STRIKER

SASH PART 1127509
FRAME PART PAGE 140

12 SASH TURN LIMITER

SASH TURN LIMITER CONCEALED ²⁾ 1136166

13 PACKERS

REBATE STAY ARM PAGE 131
CORNER PIVOT PAGE 131
TURN LIMITER PAGE 131

¹⁾ MISHANDLING DEVICE NOT AVAILABLE

²⁾ WITHOUT PACKERS - SEE **13**

* mishandling device serves as a sash lifter

APPLICATION DIAGRAM

Sash rebate height (SRH) in mm

Sash rebate width (SRW) in mm

Glass mass [kg/m²]

- Impermissible size range
- 20 kg/m²
- 30 kg/m²
- 40 kg/m²
- 50 kg/m²
- 60 kg/m²
- 70 kg/m²

Conditions for the use of the application diagram:

- Bearing loads:
 - top hinge: 2200 N
 - bottom hinge: 2310 N
- The following values are to be observed with all window systems:
 - width/height ratio $Q_{\frac{B}{H}} \leq 1,5$
 - sash size $H_{\max} \leq 3 \text{ m}^2$
 - glass deduction dim. CG: $\geq 28 \text{ mm}$
 - profile weight PG: $\leq 3,25 \text{ kg/m}$

The application diagrams are generated according to IFT guidelines.

TILT - BASIC | FACE-FIT HINGE SIDE

Centered / variable handle height

1 ESPAGNOLETTE M BS 14,5 mm

Sash rebate width	Handle width	Length	Material
250-500	125-250	500	1 R 1083164
501-900	251-450	900	2 R 1083165
901-1400	451-700	1400	3 R 1083166
1401-1900	701-950	1900	4 R 1083167
1901-2400	951-1200	2400	4 R 1083168

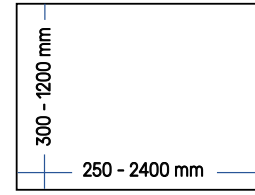
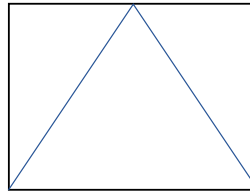

2 REBATE CENTER HINGE

REBATE CENTER HINGE 12/20-13 - adjustable 1083268

3 STAY BEARING

STAY BEARING WITH PIN K3 1083250

4 TILT STAY

TILT STAY for GROOVE 1099154
TILT STAY for ESPAGNOLETTE 1099152

5 STRIKERS

STRIKER [PAGE 139](#)

6 COVER CAPS

STAY BEARING [PAGE 134](#)
REBATE CENTER HINGE / STAY ARM [PAGE 134](#)

* for SRH > 800 mm, next scheme (STANDARD) is recommended

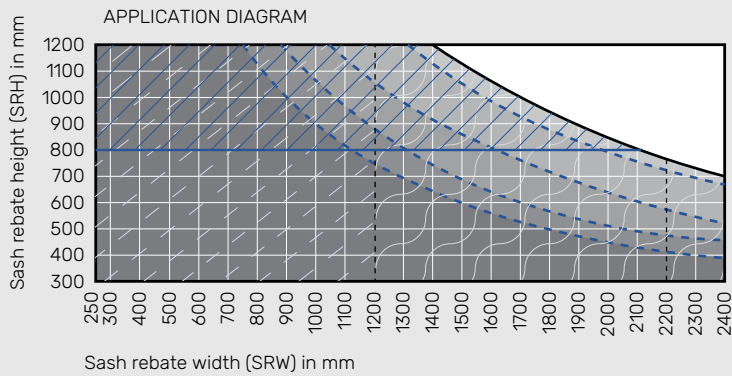
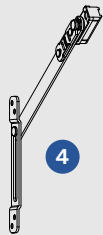
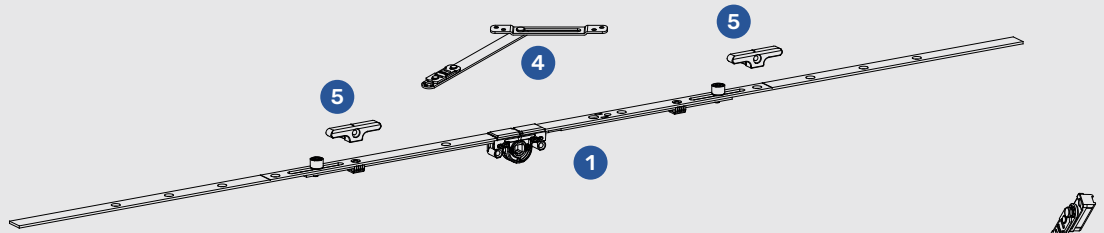

- Glass mass [kg/m²]
- Impermissible size range
 - 30 kg/m²
 - 40 kg/m²
 - 50 kg/m²
 - 60 kg/m²
 - 70 kg/m²



Conditions for the use of the application diagram:

- Glass deduction dim. CG: ≥ 28 mm,
- profile weight PG: $\leq 3,25$ kg/m.

* The application diagrams are generated according to IFT guidelines.

! TILT STAYS MUST BE INSTALLED ON BOTH SIDES - recommended by directive FPKF

- ONE TILT STAY UP
- TWO TILT STAY UPS

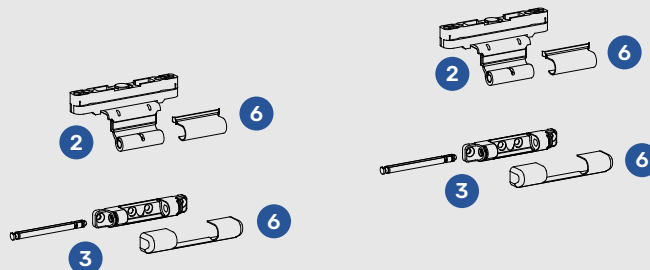

TILT - STANDARD | FACE-FIT HINGE SIDE

Centered / variable handle height

1 T&T ESPAGNOLETTE M BS 14,5 mm

Sash rebate width	Handle width	Lenght	Material
420-660	210-330	380	1083117
601-1000	300-500	720	1 R 1088473
900-1400	450-700	1120	1 R 1098964
1401-1800	701-900	1520	1 R 1098965
1601-2000	801-1000	1720	2 R 1098966
2001-2400	1001-1200	2120	2 R 1098967

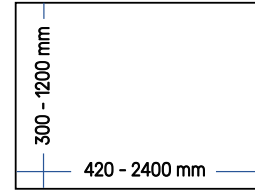
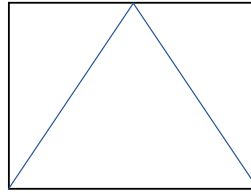

2 LOCK BOLT

LOCK BOLT 140 1 R 1102394

3 LOCK BOLT

LOCK BOLT 140/90 1 R 1102395

4 CENTER LOCK

Sash rebate height	Lenght	Material
801-1200	500/550	2 R 1083058

5 REBATE CENTER HINGE

REBATE CENTER HINGE 12/20-13 - adjustable 1083268

6 STAY BEARING

STAY BEARING WITH PIN K3 1083250

7 TILT STAY

TILT STAY for GROOVE 1099154
TILT STAY for ESPAGNOLETTE / CENTER LOCK 1099152

8 STRIKERS

STRIKER PAGE 139

9 COVER CAPS

STAY BEARING PAGE 134
REBATE CENTER HINGE / STAY ARM PAGE 134

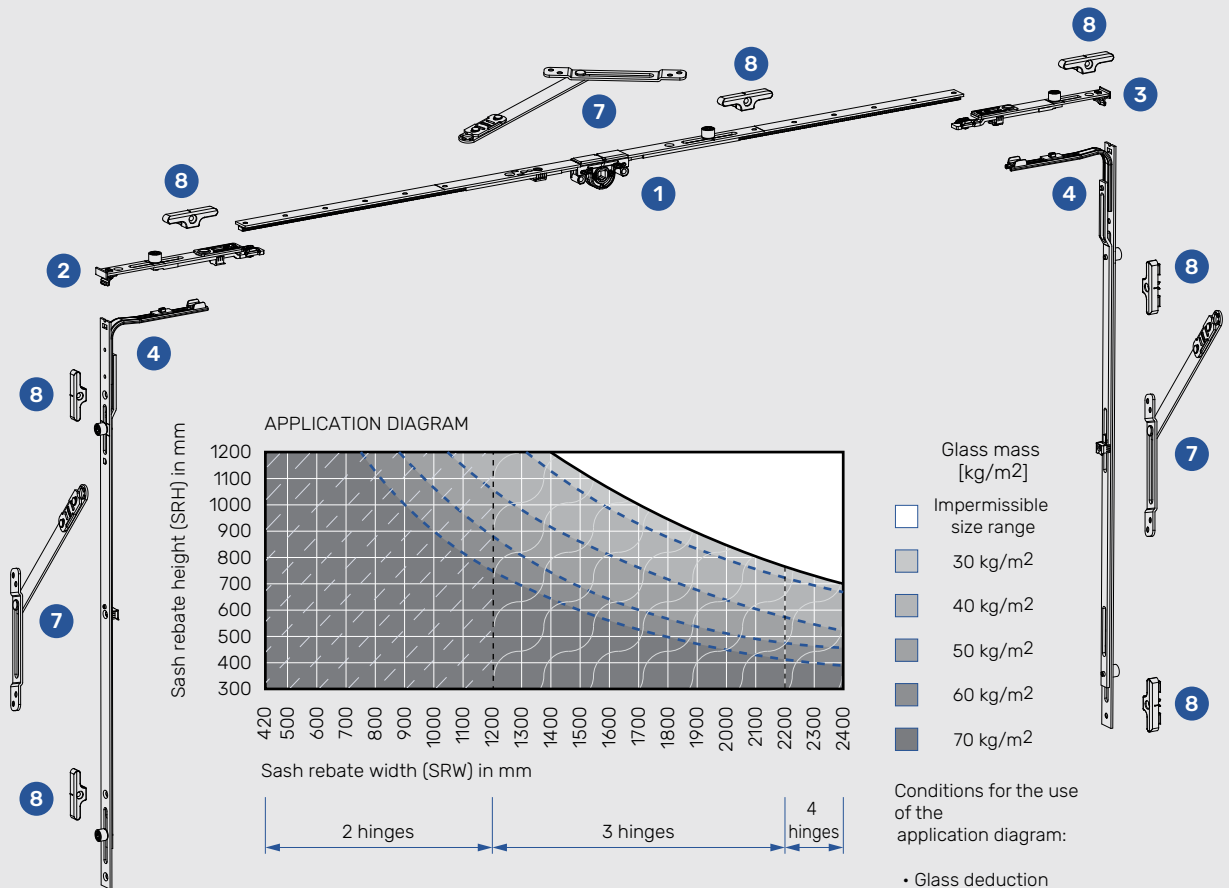

* The application diagrams are generated according to IFT guidelines.

! TILT STAYS MUST BE INSTALLED ON BOTH SIDES - recommended by directive FPKF

- ONE TILT STAY UP
- TWO TILT STAY UPS

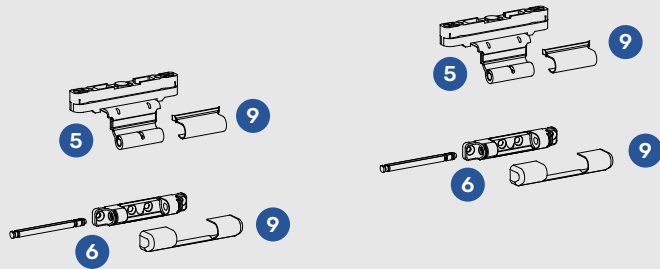

TILT - BASIC | CONCEALED HINGE SIDE

Centered / variable handle height

1 ESPAGNOLETTE M BS 14,5 mm

Sash rebate width	Handle width	Length	Material
250-500	125-250	500	1 R 1083164
501-900	251-450	900	2 R 1083165
901-1400	451-700	1400	3 R 1083166
1401-1900	701-950	1900	4 R 1083167
1901-2400	951-1200	2400	4 R 1083168

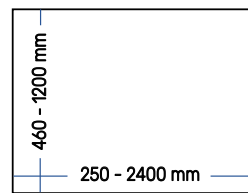
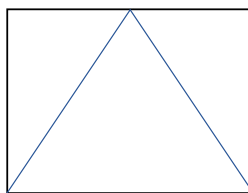

2 REBATE STAY ARM

REBATE STAY ARM CONCEALED 12/20-13¹⁾ L PAGE 129

3 REBATE STAY ARM

REBATE STAY ARM CONCEALED 12/20-13¹⁾ R PAGE 129

4 REBATE STAY ARM GUIDE

REBATE STAY ARM GUIDE 1141516

5 TILT STAY

TILT STAY for GROOVE 1099154
TILT STAY for ESPAGNOLETTE 1099152

6 STRIKERS

STRIKER PAGE 139

7 CONCEALED STRIKER

SASH PART 1127509
FRAME PART PAGE 140

8 PACKERS

REBATE STAY ARM PAGE 131

¹⁾ WITHOUT PACKERS - SEE 8

* for SRH > 800 mm, next scheme (STANDARD) is recommended

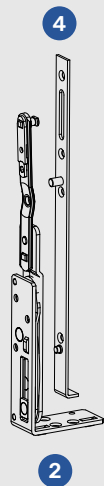
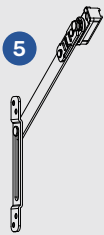
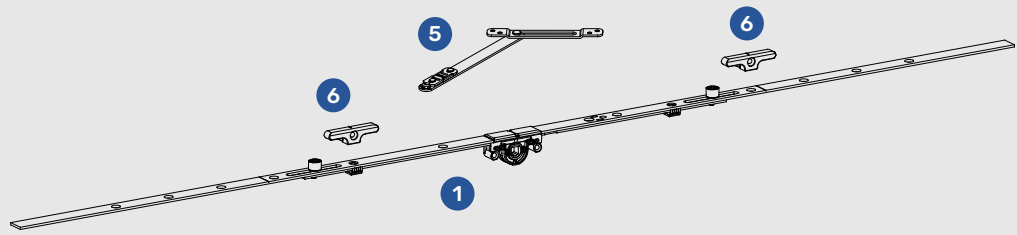

Sash rebate height (SRH) in mm

APPLICATION DIAGRAM

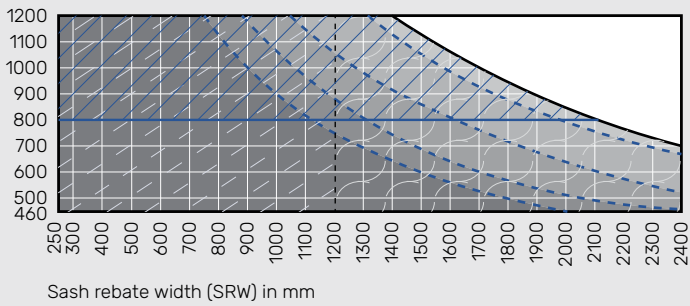

Sash rebate width (SRW) in mm

* The application diagrams are generated according to IFT guidelines.

! TILT STAYS MUST BE INSTALLED ON BOTH SIDES - recommended by directive FPKF

- ONE TILT STAY UP
- TWO TILT STAY UPS

Glass mass [kg/m²]

- Impermissible size range
- 30 kg/m²
- 40 kg/m²
- 50 kg/m²
- 60 kg/m²
- 70 kg/m²

Conditions for the use of the application diagram:

- Glass deduction dim. CG: ≥ 28 mm,
- profile weight PG: ≤ 3,25 kg/m.

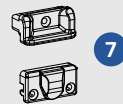
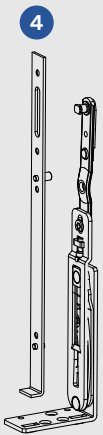

TILT - STANDARD | CONCEALED HINGE SIDE

Centered / variable handle height

1 T&T ESPAGNOLETTE M BS 14,5 mm

Sash rebate width	Handle width	Lenght	Material
420-660	210-330	380	1083117
601-1000	300-500	720	1 R 1088473
900-1400	450-700	1120	1 R 1098964
1401-1800	701-900	1520	1 R 1098965
1601-2000	801-1000	1720	2 R 1098966
2001-2400	1001-1200	2120	2 R 1098967

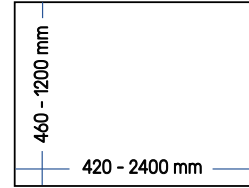
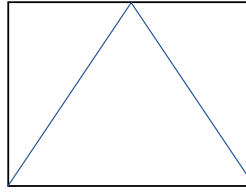

2 LOCK BOLT

LOCK BOLT 140 1 R 1102394

3 LOCK BOLT

LOCK BOLT 140/90 1 R 1102395

4 CENTER LOCK

Sash rebate height	Lenght	Material
801-1200	500/550	2 R 1083058

5 REBATE STAY ARM

REBATE STAY ARM CONCEALED 12/20-13¹⁾ L PAGE 129

6 REBATE STAY ARM

REBATE STAY ARM CONCEALED 12/20-13¹⁾ R PAGE 129

7 REBATE STAY ARM GUIDE

REBATE STAY ARM GUIDE 1141516

8 TILT STAY

TILT STAY for GROOVE 1099154
TILT STAY for ESPAGNOLETTE 1099152

9 STRIKERS

STRIKER PAGE 139

10 CONCEALED STRIKER

SASH PART 1127509
FRAME PART PAGE 140

11 PACKERS



REBATE STAY ARM PAGE 131

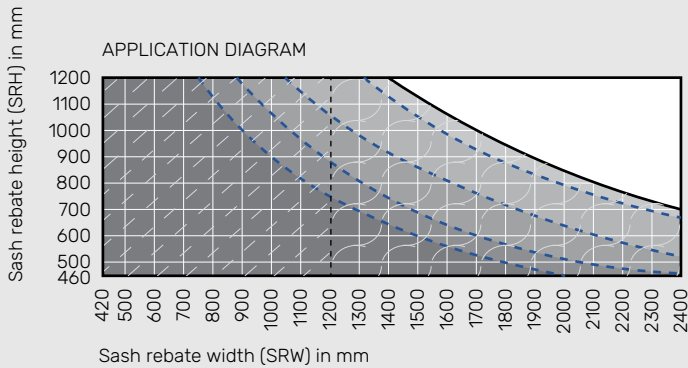
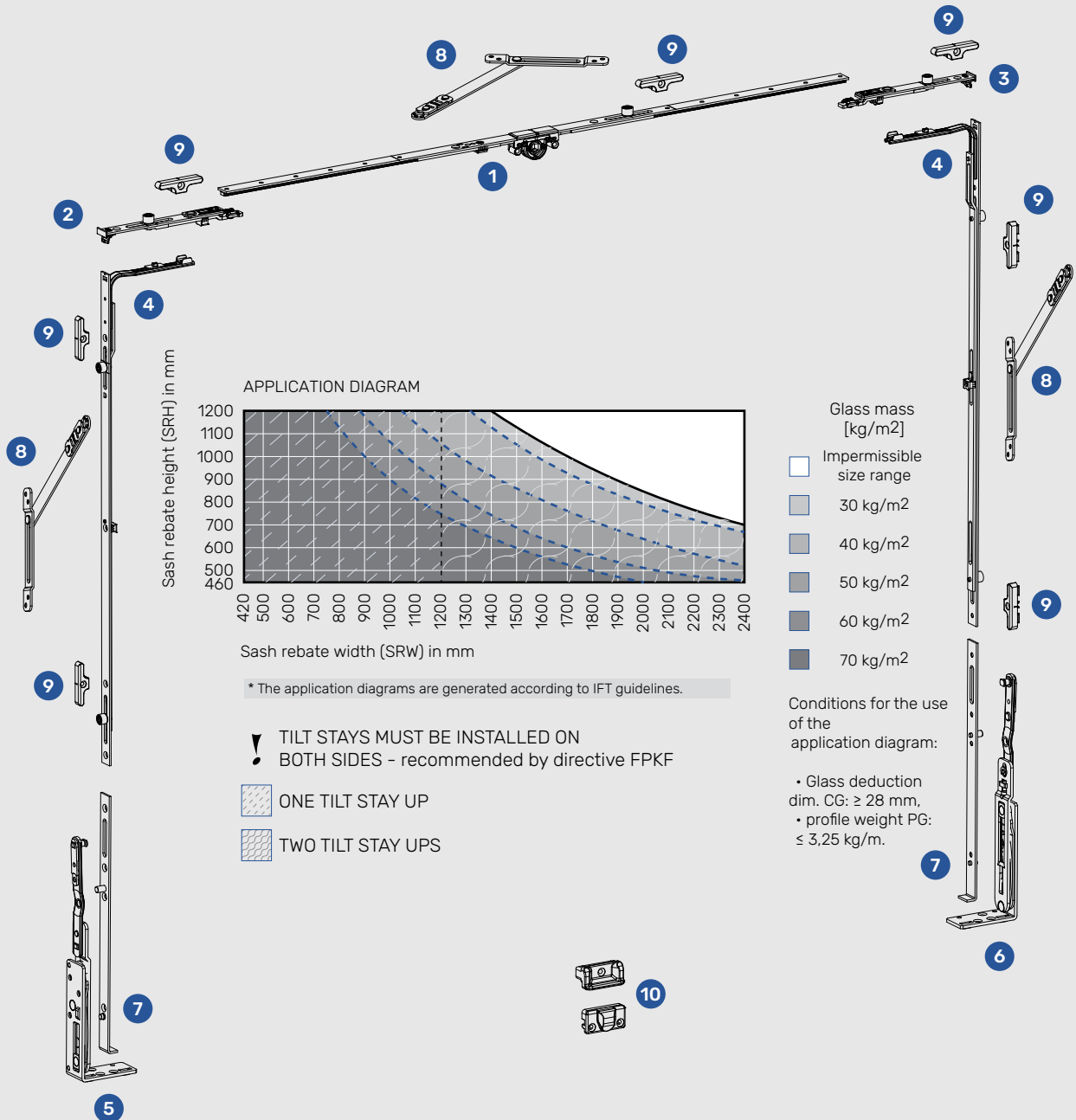





¹⁾ WITHOUT PACKERS - SEE 8



* The application diagrams are generated according to IFT guidelines.

! TILT STAYS MUST BE INSTALLED ON BOTH SIDES - recommended by directive FPKF

-  ONE TILT STAY UP
-  TWO TILT STAY UPS

- Glass mass [kg/m²]
-  Impermissible size range
 -  30 kg/m²
 -  40 kg/m²
 -  50 kg/m²
 -  60 kg/m²
 -  70 kg/m²

- Conditions for the use of the application diagram:
- Glass deduction dim. CG: ≥ 28 mm.
 - profile weight PG: ≤ 3,25 kg/m.

TURN - SECOND SASH | FACE-FIT HINGE SIDE

Fixed handle height | First sash T&Ti

1 FR. WIN. KV ESPAGNOLETTE

Sash rebate height	Handle height	Lenght	Material
460-600 ¹⁾²⁾	230	410	1118420
601-800 ²⁾	335	520	1118421
801-1000	490	720	1 R 1118423
1001-1200	335	920	1 R 1118424
1201-1400	335	1120	1 R 1118425
1401-1600	335	1320	1 R 1118426
1601-1800	335	1520	1 R 1118427
1801-2000	640	1720	2 R 1118428
2001-2200	640	1920	2 R 1118429
2201-2400	640	2120	2 R 1118430

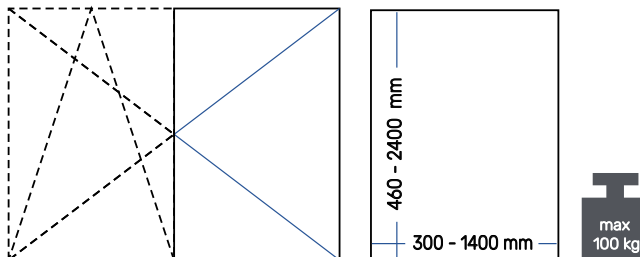

2 CORNER DRIVE - BOTTOM

STANDARD CORNER DRIVE	1 R	1103158
SHORT CORNER DRIVE	1 R	1103162

3 CORNER DRIVE - TOP

CORNER DRIVE	1 R	1103158
--------------	-----	---------

4 CENTER LOCK

Sash rebate width	Lenght	Material
801-1200	400	1 R 1083061
1201-1400	600	1 R 1083062

5 REBATE STAY ARM

REBATE STAY ARM 12/20-13	L	1083263
REBATE STAY ARM 12/20-13	R	1083262

6 STAY BEARING

STAY BEARING WITH PIN K3	1083250
--------------------------	---------

7 CORNER HINGE

CORNER HINGE K3	1083241
-----------------	---------

8 CORNER PIVOT REST

CORNER PIVOT REST K3	1083247
----------------------	---------

9 MISHANDLING DEVICE

MISHANDLING DEVICE for espagnolette	1083295
-------------------------------------	---------

10 STRIKERS

STRIKER	PAGE 139
---------	----------

11 CONCEALED STRIKER

SASH PART	1127509
FRAME PART	PAGE 140

12 COVER CAPS

STAY BEARING	PAGE 134
REBATE STAY ARM / STAY ARM	PAGE 134
CORNER HINGE	PAGE 134
CORNER PIVOT REST	PAGE 134
CORNER PIVOT REST - FLAT	PAGE 134

¹⁾ MUST USE SHORT CORNER DRIVE **1103162** ON BOTTOM

²⁾ MISHANDLING DEVICE NOT AVAILABLE

* position the upper corner drives' R cams into vertical position

APPLICATION DIAGRAM

Sash rebate height (SRH) in mm

Sash rebate width (SRW) in mm

Glass mass [kg/m²]

- Impermissible size range
- 20 kg/m²
- 30 kg/m²
- 40 kg/m²
- 50 kg/m²
- 60 kg/m²
- 70 kg/m²

Conditions for the use of the application diagram:

- Bearing loads:
 - top hinge: 2710 N
 - bottom hinge: 2890 N
- The following values are to be observed with all window systems:
 - width/height ratio $Q_{B/H} \leq 1,5$
 - sash size $H_{max} \leq 3 \text{ m}^2$
 - glass deduction dim. CG: $\geq 28 \text{ mm}$
 - profile weight PG: $\leq 3,25 \text{ kg/m}$

* The application diagrams are generated according to IFT guidelines.

TURN - SECOND SASH | FACE-FIT HINGE SIDE

Centered / variable handle height | First sash T&Ti

1 FR. WIN. ESPAGNOLETTE M

Sash rebate height	Handle height	Lenght	Material
500-680 ¹⁾	250-380	400	1098116
600-1000	387-586	720	1 R 1098120
900-1400	350-550	1120	1 R 1098122
1401-1800	350-550	1520	1 R 1098123
1601-2000	350-550	1720	2 R 1098124
2001-2400	350-550	2120	2 R 1098125

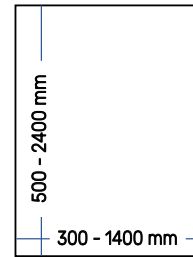
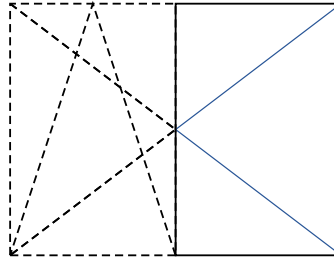

2 CORNER DRIVE - BOTTOM

STANDARD CORNER DRIVE 1 R 1103158

3 CORNER DRIVE - TOP

STANDARD CORNER DRIVE 1 R 1103158

4 CENTER LOCK

Sash rebate width	Lenght	Material
801-1200	400	1 R 1083061
1201-1400	600	1 R 1083062

5 REBATE STAY ARM

REBATE STAY ARM 12/20-13 L 1083263
REBATE STAY ARM 12/20-13 R 1083262

6 STAY BEARING

STAY BEARING WITH PIN K3 1083250

7 CORNER HINGE

CORNER HINGE K3 1083241

8 CORNER PIVOT REST

CORNER PIVOT REST K3 1083247

9 MISHANDLING DEVICE

MISHANDLING DEVICE for espagnolette 1083295

10 STRIKERS

STRIKER PAGE 139

11 CONCEALED STRIKER

SASH PART 1127509
FRAME PART PAGE 140

12 COVER CAPS

STAY BEARING PAGE 134
REBATE STAY ARM / STAY ARM PAGE 134
CORNER HINGE PAGE 134
CORNER PIVOT REST PAGE 134
CORNER PIVOT REST - FLAT PAGE 134

¹⁾ MISHANDLING DEVICE NOT AVAILABLE

* position the upper corner drives' R cams into vertical position

APPLICATION DIAGRAM

Sash rebate height (SRH) in mm

Sash rebate width (SRW) in mm

Glass mass [kg/m²]

- Impermissible size range
- 20 kg/m²
- 30 kg/m²
- 40 kg/m²
- 50 kg/m²
- 60 kg/m²
- 70 kg/m²

Conditions for the use of the application diagram:

- Bearing loads:
 - top hinge: 2710 N
 - bottom hinge: 2890 N
- The following values are to be observed with all window systems:
 - width/height ratio $Q_{B/H} \leq 1,5$
 - sash size $H_{max} \leq 3 \text{ m}^2$
 - glass deduction dim. CG: $\geq 28 \text{ mm}$
 - profile weight PG: $\leq 3,25 \text{ kg/m}$

* The application diagrams are generated according to IFT guidelines.

TURN - SECOND SASH | FACE-FIT HINGE SIDE

Fixed handle height | First sash T&T

1 FR. WIN. KV ESPAGNOLETTE

Sash rebate height	Handle height	Lenght	Material
600-800 ¹⁾	335	520	1118421
801-1000	490	720	1 R 1118423
1001-1200	335	920	1 R 1118424
1201-1400	335	1120	1 R 1118425
1401-1600	335	1320	1 R 1118426
1601-1800	335	1520	1 R 1118427
1801-2000	640	1720	2 R 1118428
2001-2200	640	1920	2 R 1118429
2201-2400	640	2120	2 R 1118430

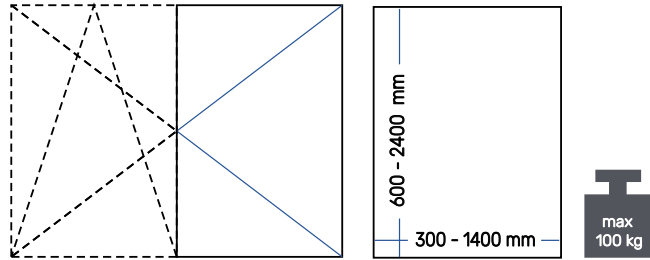

2 FR. WIN. T&T LOCK BOLT

T&T LOCK BOLT 11 mm 1102621

3 FR. WIN. CONNECTOR with STRIKER

CONNECTOR WITH STRIKER 1110929

4 CENTER LOCK

Sash rebate width	Lenght	Material
801-1200	500 / 550	2 R 1083058
1201-1400	800 / 850	2 R 1083059

5 REBATE STAY ARM

REBATE STAY ARM 12/20-13 L 1083263
REBATE STAY ARM 12/20-13 R 1083262

6 STAY BEARING

STAY BEARING WITH PIN K3 1083250

7 CORNER HINGE

CORNER HINGE K3 1083241

8 CORNER PIVOT REST

CORNER PIVOT REST K3 1083247

9 MISHANDLING DEVICE

MISHANDLING DEVICE for espagnolette 1083295

10 STRIKERS

STRIKER PAGE 139
SECOND SASH STRIKER for shootbolt PAGE 142

11 CONCEALED STRIKER

SASH PART 1127509
FRAME PART PAGE 140

12 COVER CAPS

STAY BEARING PAGE 134
REBATE STAY ARM / STAY ARM PAGE 134
CORNER HINGE PAGE 134
CORNER PIVOT REST PAGE 134
CORNER PIVOT REST - FLAT PAGE 134

¹⁾ MISHANDLING DEVICE NOT AVAILABLE

APPLICATION DIAGRAM

Sash rebate height (SRH) in mm

Sash rebate width (SRW) in mm

Glass mass [kg/m²]

- Impermissible size range
- 20 kg/m²
- 30 kg/m²
- 40 kg/m²
- 50 kg/m²
- 60 kg/m²
- 70 kg/m²

Conditions for the use of the application diagram:

- Bearing loads:
 - top hinge: 2710 N
 - bottom hinge: 2890 N
- The following values are to be observed with all window systems:
 - width/height ratio $Q_{B/H} \leq 1,5$
 - sash size $H_{max} \leq 3 \text{ m}^2$
 - glass deduction dim. CG: $\geq 28 \text{ mm}$
 - profile weight PG: $\leq 3,25 \text{ kg/m}$

* The application diagrams are generated according to IFT guidelines.

TURN - SECOND SASH | FACE-FIT HINGE SIDE

Centered / variable handle height | First sash T&T

1 FR. WIN. ESPAGNOLETTE M

Sash rebate height	Handle height	Lenght	Material
500-680 ¹⁾	290-380	400	1098116
600-1000 ¹⁾	387-586	720	1 R 1098120
900-1400	350-550	1120	1 R 1098122
1401-1800	350-550	1520	1 R 1098123
1601-2000	350-550	1720	2 R 1098124
2001-2400	350-550	2120	2 R 1098125

2 FR. WIN. T&T LOCK BOLT

T&T LOCK BOLT 11 mm 1102621

3 FR. WIN. CONNECTOR with STRIKER

CONNECTOR WITH STRIKER 1110929

4 CENTER LOCK

Sash rebate width	Lenght	Material
801-1200	500 / 550	2 R 1083058
1201-1400	800 / 850	2 R 1083059

5 REBATE STAY ARM

REBATE STAY ARM 12/20-13 L 1083263
REBATE STAY ARM 12/20-13 R 1083262

6 STAY BEARING

STAY BEARING WITH PIN K3 1083250

7 CORNER HINGE

CORNER HINGE K3 1083241

8 CORNER PIVOT REST

CORNER PIVOT REST K3 1083247

9 MISHANDLING DEVICE

MISHANDLING DEVICE for espagnolette 1083295

10 STRIKERS

STRIKER PAGE 139
SECOND SASH STRIKER for shootbolt PAGE 142

11 CONCEALED STRIKER

SASH PART 1127509
FRAME PART PAGE 140

12 COVER CAPS

STAY BEARING PAGE 134
REBATE STAY ARM / STAY ARM PAGE 134
CORNER HINGE PAGE 134
CORNER PIVOT REST PAGE 134
CORNER PIVOT REST - FLAT PAGE 134

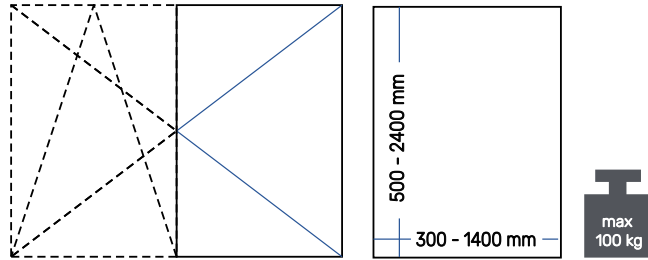

¹⁾ MISHANDLING DEVICE NOT AVAILABLE

APPLICATION DIAGRAM

Sash rebate height (SRH) in mm

Sash rebate width (SRW) in mm

Glass mass [kg/m²]

- Impermissible size range
- 20 kg/m²
- 30 kg/m²
- 40 kg/m²
- 50 kg/m²
- 60 kg/m²
- 70 kg/m²

Conditions for the use of the application diagram:

- Bearing loads:
 - top hinge: 2710 N
 - bottom hinge: 2890 N
- The following values are to be observed with all window systems:
 - width/height ratio $Q_{B/H}$: ≤ 1.5
 - sash size H_{max} : $\leq 3 \text{ m}^2$
 - glass deduction dim. CG: $\geq 28 \text{ mm}$
 - profile weight PG: $\leq 3,25 \text{ kg/m}$

* The application diagrams are generated according to IFT guidelines.

TURN - SECOND SASH | FACE-FIT HINGE SIDE

Shootbolts

- 1 SHOOTBOLT with striker - TOP
SHOOTBOLT WITH STRIKER 11 mm 1083253
- 2 SHOOTBOLT with striker - TOP
SHOOTBOLT WITHOUT STRIKER 140 11 mm 1083254
- 3 SHOOTBOLT with T&T striker - BOTTOM
SHOOTBOLT WITH T&T STRIKER 11 mm 1083252

4 CENTER LOCK

Sash rebate width	Lenght	Material
801-1200	500 / 550	2 R 1083058
1201-1400	800 / 850	2 R 1083059

- 5 REBATE STAY ARM
REBATE STAY ARM 12/20-13 L 1083263
REBATE STAY ARM 12/20-13 R 1083262

- 6 STAY BEARING
STAY BEARING WITH PIN K3 1083250

- 7 CORNER HINGE
CORNER HINGE K3 1083241

- 8 CORNER PIVOT REST
CORNER PIVOT REST K3 1083247

- 9 MISHANDLING DEVICE
MISHANDLING DEVICE - OHG 1083293

- 10 STRIKERS
STRIKER [PAGE 139](#)
STRIKER - OHG 1083207
SECOND SASH STRIKER for shootbolt [PAGE 142](#)

- 11 CONCEALED STRIKER
SASH PART 1127509
FRAME PART [PAGE 140](#)

- 12 COVER CAPS
STAY BEARING [PAGE 134](#)
REBATE STAY ARM / STAY ARM [PAGE 134](#)
CORNER HINGE [PAGE 134](#)
CORNER PIVOT REST [PAGE 134](#)
CORNER PIVOT REST - FLAT [PAGE 134](#)

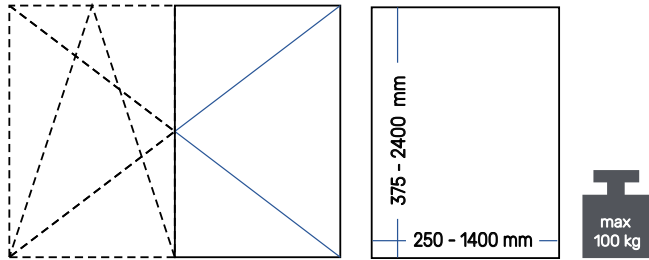

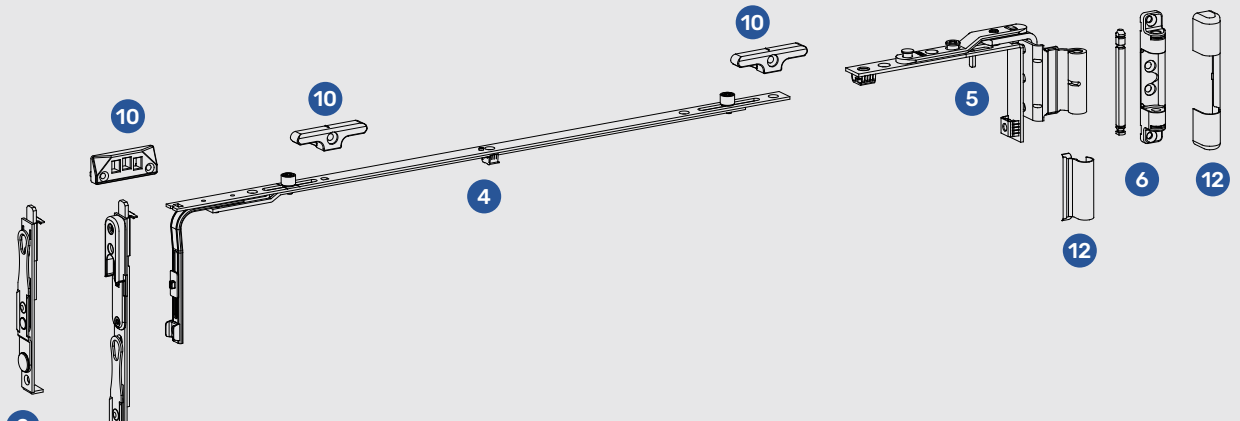

APPLICATION DIAGRAM

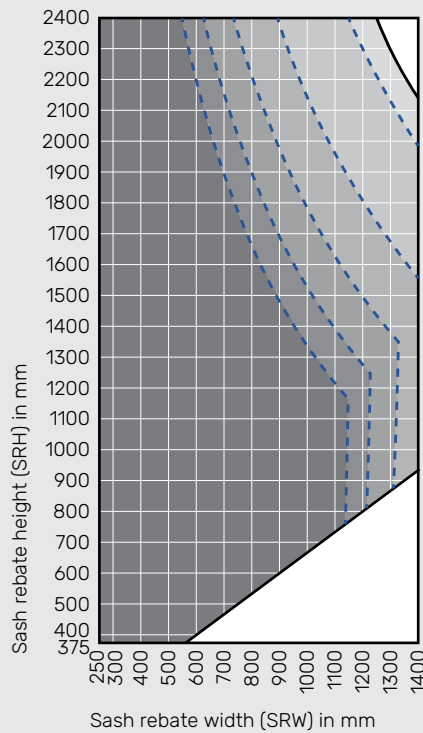

Glass mass [kg/m²]

- Impermissible size range
- 20 kg/m²
- 30 kg/m²
- 40 kg/m²
- 50 kg/m²
- 60 kg/m²
- 70 kg/m²

Conditions for the use of the application diagram:

- Bearing loads:
 - top hinge: 2710 N
 - bottom hinge: 2890 N
- The following values are to be observed with all window systems:
 - width/height ratio $Q_{G/H} \leq 1.5$
 - sash size $H_{max} \leq 3 \text{ m}^2$
 - glass deduction dim. CG: $\geq 28 \text{ mm}$
 - profile weight PG: $\leq 3.25 \text{ kg/m}$

* The application diagrams are generated according to IFT guidelines.

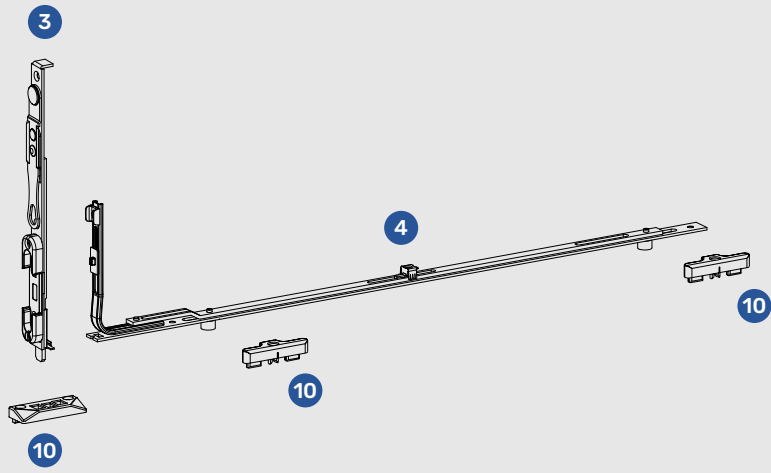
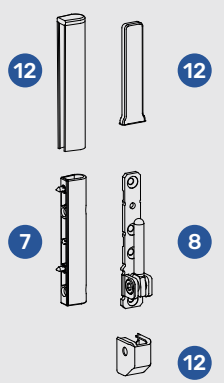
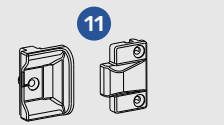

TURN - SECOND SASH - RC 1 SECURITY

FACE-FIT HINGE SIDE

Fixed handle height | First sash T&Ti

1 FR. WIN. KV ESPAGNOLETTE

Sash rebate height	Handle height	Length	Material
460-600 ¹⁾²⁾	170	410	1118420
601-800 ²⁾	263	520	1118421
801-1000	413	720	1 R 1118423
1001-1200	513	920	1 R 1118424
1201-1400	563	1120	1 R 1118425
1401-1600	563	1320	1 R 1118426
1601-1800	563	1520	1 R 1118427
1801-2000	1000	1720	2 R 1118428
2001-2200	1000	1920	2 R 1118429
2201-2400	1000	2120	2 R 1118430

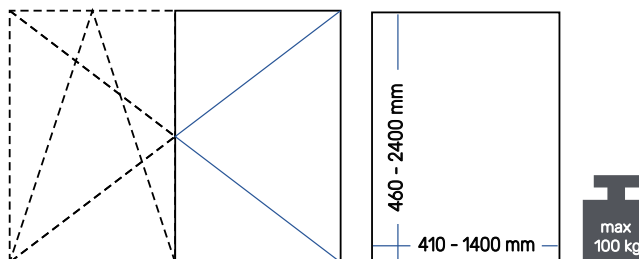

2 CORNER DRIVE - TOP

STANDARD CORNER DRIVE	1 RS	1100983
-----------------------	------	---------

3 CORNER DRIVE - BOTTOM

STANDARD CORNER DRIVE	1 RS	1100983
SHORT CORNER DRIVE	1 RS	1100986

4 SASH STAY GUIDE - turn only

Sash rebate width	Type / length	Material Nr.
410-610	250 / 470	1105855
611-810	350 / 670	1105856
811-1010	500 / 870	1 R 1105857
1011-1210	350 / 670 + 400	1 R 1105856+1102897
1211-1400	500 / 870 + 400	1+1 R 1105857+1102897

5 STAY ARM

ONLY SYSTEM 12/20-13

Sash rebate width	Type / length	Pos.	Material
411-610	250	L	1083016
		R	1083017
611-810	350	L	1083018
		R	1083019
811-1400	500	L	1083020
		R	1083021

6 SECURITY CORNER LOCK

SECURITY CORNER LOCK 180 mm	1 RS	1100987
-----------------------------	------	---------

7 CENTER LOCK - VERTICAL

Sash rebate height	Length	Material
801-1200	400 1 R	1083061
1201-1600	600 1 R	1083062
1601-2000	600 EX 1 R + 600 1 R	1102900+1083062
2001-2200	2 x 600 EX 1 R + 400 1 R	2x1102900+1083061
2201-2400	2 x 600 EX 1 R + 600 1 R	2x1102900+1083062

8 CENTER LOCK - HORIZONTAL

Sash rebate width	Length	Material
340-410	200 1 RS	1101005
541-740	400 1 RS	1101006
741-940	600 1 RS	1101012
941-1140	600 EX 1 R + 200 1 RS	1102900+1101005
1141-1340	600 EX 1 R + 400 1 RS	1102900+1101006
1341-1400	600 EX 1 R + 600 1 RS	1102900+1101012

9 STAY BEARING

STAY BEARING WITH PIN K6	1105598
--------------------------	---------

10 CORNER HINGE

CORNER HINGE K6	1083242
-----------------	---------

11 CORNER PIVOT REST

CORNER PIVOT REST K6	1105596
----------------------	---------

12 MISHANDLING DEVICE

MISHANDLING DEVICE for espagnolette	1083295
-------------------------------------	---------

13 STRIKERS

SECURITY STRIKER	PAGE 140
STRIKER	PAGE 139

14 GROOVE SPACER

GROOVE SPACER 12 mm	1127521
---------------------	---------

15 COVER CAPS

STAY BEARING	PAGE 134
STAY ARM	PAGE 134
CORNER HINGE	PAGE 134
CORNER PIVOT REST	PAGE 134
CORNER PIVOT REST - FLAT	PAGE 134

¹⁾ MUST USE SHORT CORNER DRIVE **1100986** ON BOTTOM

²⁾ MISHANDLING DEVICE NOT AVAILABLE

* 4 security locking points

* groove spacers are necessary

* position the **RS** cam on the upper corner drive into vertical position

APPLICATION DIAGRAM

Sash rebate height (SRH) in mm

Sash rebate width (SRW) in mm

Glass mass [kg/m²]

- Impermissible size range
- 20 kg/m²
- 30 kg/m²
- 40 kg/m²
- 50 kg/m²
- 60 kg/m²
- 70 kg/m²

Category of resistance: P4A glass

Conditions for the use of the application diagram:

- Bearing loads:
 - top hinge: 2710 N
 - bottom hinge: 2890 N
- The following values are to be observed with all window systems:
 - width/height ratio $Q_{B/H} \leq 1,5$
 - sash size $H_{max} \leq 3 \text{ m}^2$
 - glass deduction dim. CG: $\geq 28 \text{ mm}$
 - profile weight PG: $\leq 3,25 \text{ kg/m}$

* The application diagrams are generated according to IFT guidelines.

RC1 security is a system test meaning, that ARX as a hardware producer can only give recommendations for hardware assembled into finished product (window). ARX can't guarantee that the test will be positive solely on the base of hardware recommendations.

TURN - SECOND SASH - RC 1 SECURITY

FACE-FIT HINGE SIDE

Centered / variable handle height | First sash T&Ti

1 FR. WIN. ESPAGNOLETTE M

Sash rebate height	Handle height	Length	Material
500-680 ¹⁾	290-380	400	1098116
600-1000	387-586	720	1098120
900-1400	350-550	1120	1098122
1401-1800	350-550	1520	1098123
1601-2000	350-550	1720	1098124
2001-2400	350-550	2120	1098125

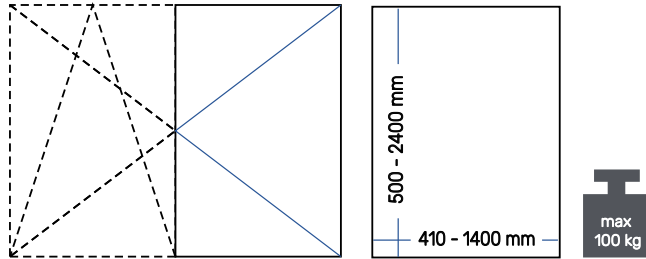

2 CORNER DRIVE - TOP

STANDARD CORNER DRIVE 1 RS 1100983

3 CORNER DRIVE - BOTTOM

STANDARD CORNER DRIVE 1 RS 1100983

4 SASH STAY GUIDE - turn only

Sash rebate width	Type / length	Material Nr.
410-610	250 / 470	1105855
611-810	350 / 670	1105856
811-1010	500 / 870	1 R 1105857
1011-1210	350 / 670 + 400	1 R 1105856+1102897
1211-1400	500 / 870 + 400	1+1 R 1105857+1102897

5 STAY ARM

ONLY SYSTEM 12/20-13

Sash rebate width	Type / length	Pos.	Material
411-610	250	L	1083016
		R	1083017
611-810	350	L	1083018
		R	1083019
811-1400	500	L	1083020
		R	1083021

6 SECURITY CORNER LOCK

SECURITY CORNER LOCK 180 mm 1 RS 1100987

7 CENTER LOCK - VERTICAL

Sash rebate height	Length	Material
801-1200	400 1 R	1083061
1201-1600	600 1 R	1083062
1601-2000	600 EX 1 R + 600 1 R	1102900+1083062
2001-2200	2 x 600 EX 1 R + 400 1 R	2x1102900+1083061
2201-2400	2 x 600 EX 1 R + 600 1 R	2x1102900+1083062

8 CENTER LOCK - HORIZONTAL

Sash rebate width	Length	Material
340-410	200 1 RS	1101005
541-740	400 1 RS	1101006
741-940	600 1 RS	1101012
941-1140	600 EX 1 R + 200 1 RS	1102900+1101005
1141-1340	600 EX 1 R + 400 1 RS	1102900+1101006
1341-1400	600 EX 1 R + 600 1 RS	1102900+1101012

9 STAY BEARING

STAY BEARING WITH PIN K6 1105598

10 CORNER HINGE

CORNER HINGE K6 1083242

11 CORNER PIVOT REST

CORNER PIVOT REST K6 1105596

12 MISHANDLING DEVICE

MISHANDLING DEVICE for espagnolette 1083295

13 STRIKERS

SECURITY STRIKER PAGE 140
STRIKER PAGE 139

14 GROOVE SPACER

GROOVE SPACER 12 mm 1127521

15 COVER CAPS

STAY BEARING PAGE 134
STAY ARM PAGE 134
CORNER HINGE PAGE 134
CORNER PIVOT REST PAGE 134
CORNER PIVOT REST - FLAT PAGE 134

* 4 security locking points

* groove spacers are necessary

* position the RS cam on the upper corner drive into vertical position

¹⁾ MISHANDLING DEVICE NOT AVAILABLE

APPLICATION DIAGRAM

Sash rebate height (SRH) in mm

Sash rebate width (SRW) in mm

Glass mass [kg/m²]

- Impermissible size range
- 20 kg/m²
- 30 kg/m²
- 40 kg/m²
- 50 kg/m²
- 60 kg/m²
- 70 kg/m²

Category of resistance: P4A glass

Conditions for the use of the application diagram:

- Bearing loads:
 - top hinge: 2710 N
 - bottom hinge: 2890 N
- The following values are to be observed with all window systems:
 - width/height ratio $Q_{g/h}$: $\leq 1,5$
 - sash size H_{max} : $\leq 3 \text{ m}^2$
 - glass deduction dim. CG: $\geq 28 \text{ mm}$
 - profile weight PG: $\leq 3,25 \text{ kg/m}$

* The application diagrams are generated according to IFT guidelines.

RC1 security is a system test meaning, that ARX as a hardware producer can only give recommendations for hardware assembled into finished product (window). ARX can't guarantee that the test will be positive solely on the base of hardware recommendations.

TURN - SECOND SASH | CONCEALED HINGE SIDE

Fixed handle height | First sash T&Ti

1 FR. WIN. KV ESPAGNOLETTE

Sash rebate height	Handle height	Lenght	Material
460-600 ¹⁾²⁾	230	410	1118420
601-800 ²⁾	335	520	1118421
801-1000	490	720	1 R 1118423
1001-1200	335	920	1 R 1118424
1201-1400	335	1120	1 R 1118425
1401-1600	335	1320	1 R 1118426
1601-1800	335	1520	1 R 1118427
1801-2000	640	1720	2 R 1118428
2001-2200	640	1920	2 R 1118429
2201-2400	640	2120	2 R 1118430

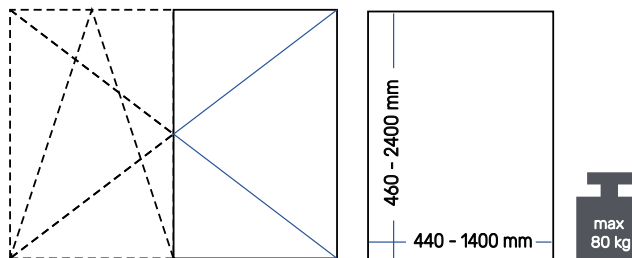

2 CORNER DRIVE - BOTTOM

STANDARD CORNER DRIVE	1 R	1103158
SHORT CORNER DRIVE	1 R	1103162

3 CORNER DRIVE - TOP

CORNER DRIVE	1 R	1103158
--------------	-----	---------

4 CENTER LOCK

Sash rebate width	Lenght	Material
801-1200	400	1 R 1083061
1201-1400	600	1 R 1083062

5 REBATE STAY ARM

REBATE STAY ARM CONCEALED 12/20-13 ³⁾	PAGE 129
--	----------

6 REBATE STAY ARM GUIDE

REBATE STAY ARM GUIDE	1141516
-----------------------	---------

7 CORNER HINGE

CORNER HINGE CONCEALED	1136163
------------------------	---------

8 CORNER PIVOT

CORNER PIVOT CONCEALED ³⁾	PAGE 130
--------------------------------------	----------

9 MISHANDLING DEVICE

MISHANDLING DEVICE for espagnolette	1083295
-------------------------------------	---------

10 STRIKERS

STRIKER	PAGE 139
---------	----------

11 CONCEALED STRIKER

SASH PART	1127509
FRAME PART	PAGE 140

12 SASH TURN LIMITER

SASH TURN LIMITER CONCEALED ³⁾	1136166
---	---------

13 PACKERS

REBATE STAY ARM	PAGE 131
CORNER PIVOT	PAGE 131
TURN LIMITER	PAGE 131

¹⁾ MUST USE SHORT CORNER DRIVE **1100986** ON BOTTOM

²⁾ MISHANDLING DEVICE NOT AVAILABLE

³⁾ WITHOUT PACKERS - SEE **8**

APPLICATION DIAGRAM

Sash rebate height (SRH) in mm

Sash rebate width (SRW) in mm

Glass mass [kg/m²]

- Impermissible size range
- 20 kg/m²
- 30 kg/m²
- 40 kg/m²
- 50 kg/m²
- 60 kg/m²
- 70 kg/m²

Conditions for the use of the application diagram:

- Bearing loads:
 - top hinge: 2200 N
 - bottom hinge: 2310 N
- The following values are to be observed with all window systems:
 - width/height ratio $Q_{B/H}$: ≤ 1.5
 - sash size H_{max} : $\leq 3 \text{ m}^2$
 - glass deduction dim. CG: $\geq 28 \text{ mm}$
 - profile weight PG: $\leq 3,25 \text{ kg/m}$

The application diagrams are generated according to IFT guidelines.

TURN - SECOND SASH | CONCEALED HINGE SIDE

Centered / variable handle height | First sash T&Ti

1 FR. WIN. ESPAGNOLETTE M

Sash rebate height	Handle height	Lenght	Material
500-680 ¹⁾	290-380	400	1098116
600-1000	387-586	720	1 R 1098120
900-1400	350-550	1120	1 R 1098122
1401-1800	350-550	1520	1 R 1098123
1601-2000	350-550	1720	2 R 1098124
2001-2400	350-550	2120	2 R 1098125

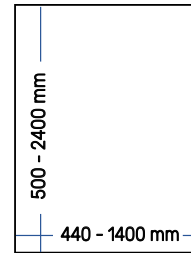
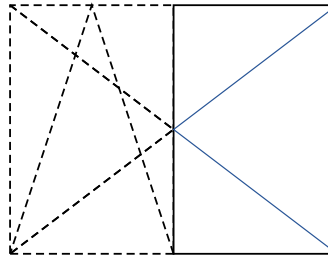

2 CORNER DRIVE

STANDARD CORNER DRIVE	1 R	1103158
-----------------------	-----	---------

3 CENTER LOCK

Sash rebate width	Lenght	Material
801-1200	400	1 R 1083061
1201-1400	600	1 R 1083062

4 REBATE STAY ARM

REBATE STAY ARM CONCEALED 12/20-13 ²⁾	PAGE 129
--	----------

5 REBATE STAY ARM GUIDE

REBATE STAY ARM GUIDE	1141516
-----------------------	---------

6 CORNER HINGE

CORNER HINGE CONCEALED	1136163
------------------------	---------

7 CORNER PIVOT

CORNER PIVOT CONCEALED ²⁾	PAGE 130
--------------------------------------	----------

8 MISHANDLING DEVICE

MISHANDLING DEVICE for espagnolette	1083295
-------------------------------------	---------

9 STRIKERS

STRIKER	PAGE 139
---------	----------

10 CONCEALED STRIKER

SASH PART	1127509
FRAME PART	PAGE 140

11 SASH TURN LIMITER

SASH TURN LIMITER CONCEALED ²⁾	1136166
---	---------

12 PACKERS

REBATE STAY ARM	PAGE 131
CORNER PIVOT	PAGE 131
TURN LIMITER	PAGE 131

¹⁾ MISHANDLING DEVICE NOT AVAILABLE

²⁾ WITHOUT PACKERS - SEE **8**

APPLICATION DIAGRAM

Sash rebate height (SRH) in mm

Sash rebate width (SRW) in mm

Glass mass [kg/m²]

- Impermissible size range
- 20 kg/m²
- 30 kg/m²
- 40 kg/m²
- 50 kg/m²
- 60 kg/m²
- 70 kg/m²

Conditions for the use of the application diagram:

- Bearing loads:
 - top hinge: 2200 N
 - bottom hinge: 2310 N
- The following values are to be observed with all window systems:
 - width/height ratio $Q_{G/H} \leq 1,5$
 - sash size $H_{max} \leq 3 \text{ m}^2$
 - glass deduction dim. CG: $\geq 28 \text{ mm}$
 - profile weight PG: $\leq 3,25 \text{ kg/m}$

The application diagrams are generated according to IFT guidelines.

TURN - SECOND SASH | CONCEALED HINGE SIDE

Fixed handle height | First sash T&T

1 FR. WIN. KV ESPAGNOLETTE

Sash rebate height	Handle height	Lenght	Material
600-800 ¹⁾	335	520	1118421
801-1000	490	720	1 R 1118423
1001-1200	335	920	1 R 1118424
1201-1400	335	1120	1 R 1118425
1401-1600	335	1320	1 R 1118426
1601-1800	335	1520	1 R 1118427
1801-2000	640	1720	2 R 1118428
2001-2200	640	1920	2 R 1118429
2201-2400	640	2120	2 R 1118430

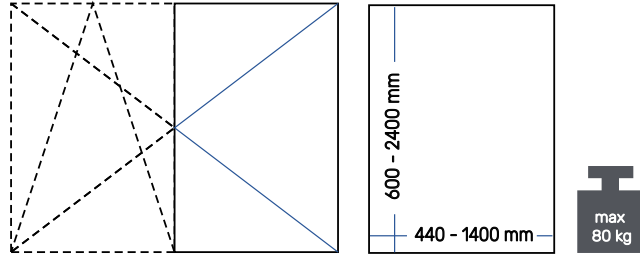

2 FR. WIN. T&T LOCK BOLT

T&T LOCK BOLT 11 mm 1102621

3 FR. WIN. CONNECTOR with STRIKER

CONNECTOR WITH STRIKER 1110929

4 CENTER LOCK

Sash rebate width	Lenght	Material
801-1200	500 / 550	2 R 1083058
1201-1400	800 / 850	2 R 1083059

5 REBATE STAY ARM

REBATE STAY ARM CONCEALED 12/20-13 ²⁾ PAGE 129

6 REBATE STAY ARM GUIDE

REBATE STAY ARM GUIDE 1141516

7 CORNER HINGE

CORNER HINGE CONCEALED 1136163

8 CORNER PIVOT

CORNER PIVOT CONCEALED ²⁾ PAGE 130

9 MISHANDLING DEVICE

MISHANDLING DEVICE for espagnolette 1083295

10 STRIKERS

STRIKER PAGE 139
SECOND SASH STRIKER for shootbolt PAGE 142

11 CONCEALED STRIKER

SASH PART 1127509
FRAME PART PAGE 140

12 SASH TURN LIMITER

SASH TURN LIMITER CONCEALED ²⁾ 1136166

13 PACKERS

REBATE STAY ARM PAGE 131
CORNER PIVOT PAGE 131
TURN LIMITER PAGE 131

¹⁾ MISHANDLING DEVICE NOT AVAILABLE

²⁾ WITHOUT PACKERS - SEE **8**

APPLICATION DIAGRAM

Sash rebate height (SRH) in mm

Sash rebate width (SRW) in mm

Glass mass [kg/m²]

- Impermissible size range
- 20 kg/m²
- 30 kg/m²
- 40 kg/m²
- 50 kg/m²
- 60 kg/m²
- 70 kg/m²

Conditions for the use of the application diagram:

- Bearing loads:
 - top hinge: 2200 N
 - bottom hinge: 2310 N
- The following values are to be observed with all window systems:
 - width/height ratio $Q_{B/H} \leq 1,5$
 - sash size $H_{max} \leq 3 \text{ m}^2$
 - glass deduction dim. CG: $\geq 28 \text{ mm}$
 - profile weight PG: $\leq 3,25 \text{ kg/m}$

The application diagrams are generated according to IFT guidelines.

TURN - SECOND SASH | CONCEALED HINGE SIDE

Centered / variable handle height | First sash T&T

1 FR. WIN. ESPAGNOLETTE M

Sash rebate height	Handle height	Lenght	Material
500-680 ¹⁾	290-380	400	1098116
600-1000 ¹⁾	387-586	720	1 R 1098120
900-1400	350-550	1120	1 R 1098122
1401-1800	350-550	1520	1 R 1098123
1601-2000	350-550	1720	2 R 1098124
2001-2400	350-550	2120	2 R 1098125

2 FR. WIN. T&T LOCK BOLT

T&T LOCK BOLT 11 mm 1102621

3 FR. WIN. CONNECTOR with STRIKER

CONNECTOR WITH STRIKER 1110929

4 CENTER LOCK

Sash rebate width	Lenght	Material
801-1200	500 / 550	2 R 1083058
1201-1400	800 / 850	2 R 1083059

5 REBATE STAY ARM

REBATE STAY ARM CONCEALED 12/20-13 ²⁾ PAGE 129

6 REBATE STAY ARM GUIDE

REBATE STAY ARM GUIDE 1141516

7 CORNER HINGE

CORNER HINGE CONCEALED 1136163

8 CORNER PIVOT

CORNER PIVOT CONCEALED ²⁾ PAGE 130

9 MISHANDLING DEVICE

MISHANDLING DEVICE for espagnolette 1083295

10 STRIKERS

STRIKER PAGE 139
SECOND SASH STRIKER for shootbolt PAGE 142

11 CONCEALED STRIKER

SASH PART 1127509
FRAME PART PAGE 140

12 SASH TURN LIMITER

SASH TURN LIMITER CONCEALED ²⁾ 1136166

13 PACKERS

REBATE STAY ARM PAGE 131
CORNER PIVOT PAGE 131
TURN LIMITER PAGE 131

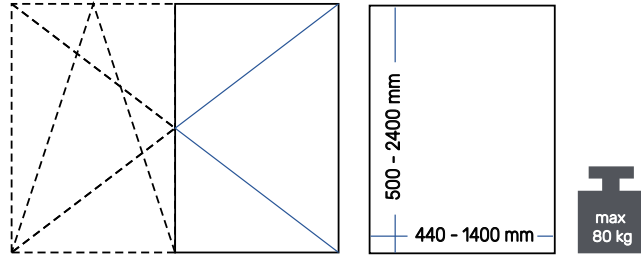

¹⁾ MISHANDLING DEVICE NOT AVAILABLE

²⁾ WITHOUT PACKERS - SEE 8

APPLICATION DIAGRAM

Sash rebate height (SRH) in mm

Sash rebate width (SRW) in mm

Glass mass [kg/m²]

- Impermissible size range
- 20 kg/m²
- 30 kg/m²
- 40 kg/m²
- 50 kg/m²
- 60 kg/m²
- 70 kg/m²

Conditions for the use of the application diagram:

- Bearing loads:
 - top hinge: 2200 N
 - bottom hinge: 2310 N
- The following values are to be observed with all window systems:
 - width/height ratio $Q_{G/Ht} \leq 1,5$
 - sash size $H_{max} \leq 3 \text{ m}^2$
 - glass deduction dim. CG: $\geq 28 \text{ mm}$
 - profile weight PG: $\leq 3,25 \text{ kg/m}$

The application diagrams are generated according to IFT guidelines.

TURN - SECOND SASH | CONCEALED HINGE SIDE

Shootbolts

- 1 **SHOOTBOLT with striker - TOP**
SHOOTBOLT WITH STRIKER 11 mm 1083253
- 2 **SHOOTBOLT with striker - TOP**
SHOOTBOLT WITHOUT STRIKER 140 11 mm 1083254
- 3 **SHOOTBOLT with T&T striker - BOTTOM**
SHOOTBOLT WITH T&T STRIKER 11 mm 1083252

4 CENTER LOCK

Sash rebate width	Lenght	Material
801-1200	500 / 550	2 R 1083058
1201-1400	800 / 850	2 R 1083059

- 5 **REBATE STAY ARM**
REBATE STAY ARM CONCEALED 12/20-13 ¹⁾ [PAGE 129](#)

- 6 **REBATE STAY ARM GUIDE**
REBATE STAY ARM GUIDE 1141516

- 7 **CORNER HINGE**
CORNER HINGE CONCEALED 1136163

- 8 **CORNER PIVOT**
CORNER PIVOT CONCEALED ¹⁾ [PAGE 130](#)

- 9 **MISHANDLING DEVICE**
MISHANDLING DEVICE - OHG 1083293

- 10 **STRIKERS**
STRIKER [PAGE 139](#)
STRIKER - OHG 1083207
SECOND SASH STRIKER for shootbolt [PAGE 142](#)

- 11 **CONCEALED STRIKER**
SASH PART 1127509
FRAME PART [PAGE 140](#)

- 12 **SASH TURN LIMITER**
SASH TURN LIMITER CONCEALED ¹⁾ 1136166

- 13 **PACKERS**
REBATE STAY ARM [PAGE 131](#)
CORNER PIVOT [PAGE 131](#)
TURN LIMITER [PAGE 131](#)

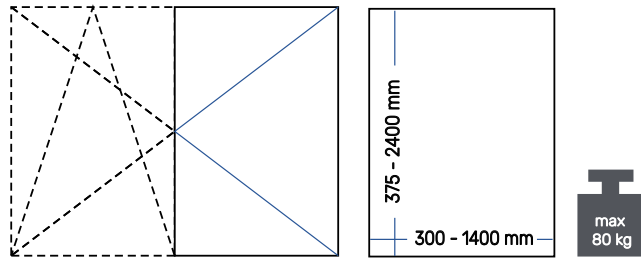

¹⁾ WITHOUT PACKERS - SEE [8](#)

1 **2** **3** **4** **5** **6** **7** **8** **9** **10** **11**

APPLICATION DIAGRAM

Sash rebate height (SRH) in mm

Sash rebate width (SRW) in mm

Glass mass [kg/m²]

- Impermissible size range
- 20 kg/m²
- 30 kg/m²
- 40 kg/m²
- 50 kg/m²
- 60 kg/m²
- 70 kg/m²

Conditions for the use of the application diagram:

- Bearing loads:
 - top hinge: 2200 N
 - bottom hinge: 2310 N
- The following values are to be observed with all window systems:
 - width/height ratio $Q_{B/H} \leq 1,5$
 - sash size $H_{max} \leq 3 \text{ m}^2$
 - glass deduction dim. CG: $\geq 28 \text{ mm}$
 - profile weight PG: $\leq 3,25 \text{ kg/m}$

The application diagrams are generated according to IFT guidelines.

T&TI - ARCHED WINDOW | FACE-FIT HINGE SIDE

Fixed handle height

1 T&T KV ESPAGNOLETTE BS 14,5 mm

Sash rebate height	Handle height	Length	Material
490-600 ¹⁾	170	410	1118431
600-800	263	520	1115131
801-1000	413	720	1 R 1115133
1001-1200	513	920	1 R 1115134
1201-1400	563	1120	1 R 1115135
1401-1600	563	1320	1 R 1115136
1601-1800	563	1520	1 R 1115137
1601-1800	1000	1520	1 R 1115138

2 LOCK BOLT

Sash rebate width	Type / length	Material Nr.
400-800	140	1 R 1102394

2a CENTER LOCK - ARCH

Sash rebate width	Type / length	Material Nr.
801-1400	590	2 R 1103143

3 CORNER DRIVE

STANDARD CORNER DRIVE 1 RS 1100983

4 CENTER LOCK - HORIZONTAL

Sash rebate width	Type / length	Material Nr.
400-650	370	1083076
651-900	620	1 R 1083077
901-1150	870	1 R 1083078
1151-1400	1120	2 R 1083079

5 CORNER LOCK

CORNER LOCK 1 R 1103166

6 CENTER LOCK - VERTICAL

Sash rebate height	Length	Material
490-700	380	1083071
701-900	580	1 R 1083072
901-1100	780	1 R 1083073
1101-1300	980	1 R 1083074
1301-1500	1180	2 R 1083075
1501-1700	1380	2 R 1084924
1701-1900	1580	2 R 1084925

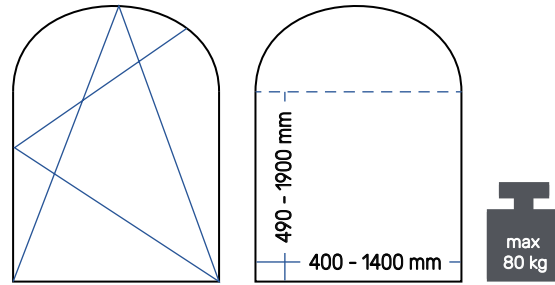

7 STAY ARM SET

STAY ARM 12/20-13 WITH SASH LIFTER 1 R 1103147

8 STAY BEARING - ADJUSTABLE

ADJUSTABLE STAY BEARING WITH PIN 1103601

9 CORNER HINGE

CORNER HINGE K3 1083241

10 CORNER PIVOT REST

CORNER PIVOT REST K3 1083247

11 MISHANDLING DEVICE

SASH PART 1093907
FRAME PART PAGE 141

12 STRIKERS

T&Ti STRIKER PAGE 137
STRIKER PAGE 139

13 COVER CAPS

ADJUSTABLE STAY BEARING PAGE 134
STAY ARM PAGE 134
CORNER HINGE PAGE 134
CORNER PIVOT REST PAGE 134
CORNER PIVOT REST - FLAT PAGE 134

¹⁾ MISHANDLING DEVICE NOT AVAILABLE

APPLICATION DIAGRAM

Sash rebate height (SRH) in mm

Sash rebate width (SRW) in mm

Glass mass [kg/m²]

- Impermissible size range
- 20 kg/m²
- 30 kg/m²
- 40 kg/m²
- 50 kg/m²
- 60 kg/m²
- 70 kg/m²

Conditions for the use of the application diagram:

- Bearing loads:
 - top hinge: 2374 N
 - bottom hinge: 2374 N
- The following values are to be observed with all window systems:
 - width/height ratio $Q_{B/H} \leq 1,5$
 - sash size $H_{max} \leq 3 \text{ m}^2$
 - glass deduction dim. CG: $\geq 28 \text{ mm}$
 - profile weight PG: $\leq 3,25 \text{ kg/m}$

* The application diagrams are generated according to IFT guidelines.

T&TI - ARCHED WINDOW | FACE-FIT HINGE SIDE

Centered / variable handle height

1 T&T ESPAGNOLETTE M BS 14,5 mm

Sash rebate height	Handle height	Length	Material
490-660 ¹⁾	245-330	380	1083117
600-1000	300-500	720	1 R 1088473
900-1400	450-700	1120	1 R 1098964
1401-1800	701-900	1520	1 R 1098965
1601-1900	801-1000	1720	2 R 1098966

2 LOCK BOLT

Sash rebate width	Type / length	Material Nr.
400-800	140	1 R 1102394

2a CENTER LOCK - ARCH

Sash rebate width	Type / length	Material Nr.
801-1400	590	2 R 1103143

3 CORNER DRIVE

STANDARD CORNER DRIVE 1 RS 1100983

4 CENTER LOCK - HORIZONTAL

Sash rebate width	Type / length	Material Nr.
400-650	370	1083076
651-900	620	1 R 1083077
901-1150	870	1 R 1083078
1151-1400	1120	2 R 1083079

5 CORNER LOCK

CORNER LOCK 1 R 1103166

6 CENTER LOCK - VERTICAL

Sash rebate height	Length	Material
490-700	380	1083071
701-900	580	1 R 1083072
901-1100	780	1 R 1083073
1101-1300	980	1 R 1083074
1301-1500	1180	2 R 1083075
1501-1700	1380	2 R 1084924
1701-1900	1580	2 R 1084925

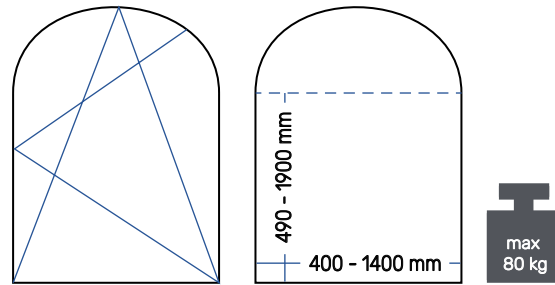

7 STAY ARM SET

STAY ARM 12/20-13 WITH SASH LIFTER 1 R 1103147

8 STAY BEARING - ADJUSTABLE

ADJUSTABLE STAY BEARING WITH PIN 1103601

9 CORNER HINGE

CORNER HINGE K3 1083241

10 CORNER PIVOT REST

CORNER PIVOT REST K3 1083247

11 MISHANDLING DEVICE

SASH PART 1093907
FRAME PART PAGE 141

12 STRIKERS

T&TI STRIKER PAGE 137
STRIKER PAGE 139

13 COVER CAPS

ADJUSTABLE STAY BEARING PAGE 134
STAY ARM PAGE 134
CORNER HINGE PAGE 134
CORNER PIVOT REST PAGE 134
CORNER PIVOT REST - FLAT PAGE 134

¹⁾ MISHANDLING DEVICE NOT AVAILABLE

APPLICATION DIAGRAM

Sash rebate height (SRH) in mm

Sash rebate width (SRW) in mm

Glass mass [kg/m²]

- Impermissible size range
- 20 kg/m²
- 30 kg/m²
- 40 kg/m²
- 50 kg/m²
- 60 kg/m²
- 70 kg/m²

Conditions for the use of the application diagram:

- Bearing loads:
 - top hinge: 2374 N
 - bottom hinge: 2374 N
- The following values are to be observed with all window systems:
 - width/height ratio $Q_{B/H} \leq 1,5$
 - sash size $H_{max} \leq 3 \text{ m}^2$
 - glass deduction dim. CG: $\geq 28 \text{ mm}$
 - profile weight PG: $\leq 3,25 \text{ kg/m}$

* The application diagrams are generated according to IFT guidelines.

T&TI - PITCHED WINDOW | FACE-FIT HINGE SIDE

Fixed handle height

1 T&T KV ESPAGNOLETTE BS 14,5 mm

Sash rebate height	Handle height	Length	Material
461-600 ¹⁾²⁾	170	410	1118431
601-800	263	520	1115131
801-1000	413	720	1 R 1115133
1001-1200	513	920	1 R 1115134
1201-1400	563	1120	1 R 1115135
1401-1600	563	1320	1 R 1115136
1601-1800	563	1520	1 R 1115137
1601-1800	1000	1520	1 R 1115138

2 LOCK BOLT

Sash rebate width	Type / length	Material Nr.
400-800	140	1 R 1102394

2a CENTER LOCK - TOP

Sash rebate width	Type / length	Material Nr.
801-1200	400	1 R 1083061
1201-1400	600	1 R 1083062

2b CORNER DRIVE - TOP

CORNER DRIVE PITCHED 1 R 1103163

3 CORNER DRIVE - BOTTOM

STANDARD CORNER DRIVE 1 RS 1100983
SHORT CORNER DRIVE 1 RS 1100986

4 CENTER LOCK - HORIZONTAL

Sash rebate width	Type / length	Material Nr.
400-650	370	1083076
651-900	620	1 R 1083077
901-1150	870	1 R 1083078
1151-1400	1120	2 R 1083079

5 CORNER LOCK

CORNER LOCK 1 R 1103166

6 CENTER LOCK - VERTICAL

Sash rebate height	Length	Material
600-700	380	1083071
701-900	580	1 R 1083072
901-1100	780	1 R 1083073
1101-1300	980	1 R 1083074
1301-1500	1180	2 R 1083075
1501-1700	1380	2 R 1084924
1701-1900	1580	2 R 1084925

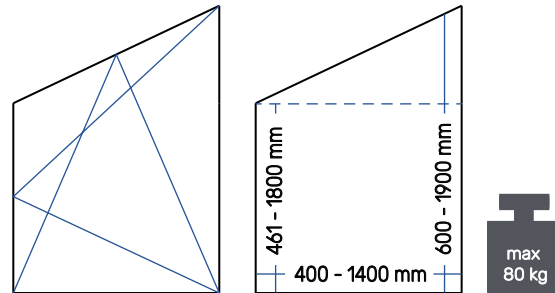

7 STAY ARM SET

STAY ARM 12/20-13 WITH SASH LIFTER 1 R 1103147

8 STAY BEARING - ADJUSTABLE

ADJUSTABLE STAY BEARING WITH PIN 1103601

9 CORNER HINGE

CORNER HINGE K3 1083241

10 CORNER PIVOT REST

CORNER PIVOT REST K3 1083247

11 MISHANDLING DEVICE

SASH PART 1093907
FRAME PART PAGE 141

12 STRIKERS

T&Ti STRIKER PAGE 137
STRIKER PAGE 139

13 COVER CAPS

ADJUSTABLE STAY BEARING PAGE 134
STAY ARM PAGE 134
CORNER HINGE PAGE 134
CORNER PIVOT REST PAGE 134
CORNER PIVOT REST - FLAT PAGE 134

¹⁾ MISHANDLING DEVICE NOT AVAILABLE

²⁾ MUST USE SHORT CORNER DRIVE ON BOTTOM

APPLICATION DIAGRAM

Sash rebate height (SRH) in mm

Sash rebate width (SRW) in mm

Glass mass [kg/m²]

- Impermissible size range
- 20 kg/m²
- 30 kg/m²
- 40 kg/m²
- 50 kg/m²
- 60 kg/m²
- 70 kg/m²

Conditions for the use of the application diagram:

- Bearing loads:
 - top hinge: 2374 N
 - bottom hinge: 2374 N
- The following values are to be observed with all window systems:
 - width/height ratio $Q_{B/H} \leq 1,5$
 - sash size $H_{max} \leq 3 \text{ m}^2$
 - glass deduction dim. CG: $\geq 28 \text{ mm}$
 - profile weight PG: $\leq 3,25 \text{ kg/m}$

* The application diagrams are generated according to IFT guidelines.

T&TI - PITCHED WINDOW | FACE-FIT HINGE SIDE

Centered / variable handle height

1 T&T ESPAGNOLETTE M BS 14,5 mm

Sash rebate height	Handle height	Lenght	Material
490-660 ¹⁾	245-330	380	1083117
600-1000	300-500	720	1 R 1088473
900-1400	450-700	1120	1 R 1098964
1401-1800	701-900	1520	1 R 1098965
1601-1900	801-1000	1720	2 R 1098966

2 LOCK BOLT

Sash rebate width	Type / length	Material Nr.
400-800	140	1 R 1102394

2a CENTER LOCK - TOP

Sash rebate width	Type / length	Material Nr.
801-1200	400	1 R 1083061
1201-1400	600	1 R 1083062

2b CORNER DRIVE - TOP

CORNER DRIVE PITCHED 1 R 1103163

3 CORNER DRIVE - BOTTOM

STANDARD CORNER DRIVE 1 RS 1100983

4 CENTER LOCK - HORIZONTAL

Sash rebate width	Type / length	Material Nr.
400-650	370	1083076
651-900	620	1 R 1083077
901-1150	870	1 R 1083078
1151-1400	1120	2 R 1083079

5 CORNER LOCK

CORNER LOCK 1 R 1103166

6 CENTER LOCK - VERTICAL

Sash rebate width	Length	Material
490-700	380	1083071
701-900	580	1 R 1083072
901-1100	780	1 R 1083073
1101-1300	980	1 R 1083074
1301-1500	1180	2 R 1083075
1501-1700	1380	2 R 1084924
1701-1900	1580	2 R 1084925

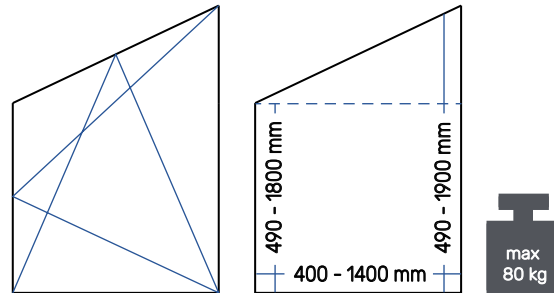

7 STAY ARM SET

STAY ARM 12/20-13 WITH SASH LIFTER 1 R 1103147

8 STAY BEARING - ADJUSTABLE

ADJUSTABLE STAY BEARING WITH PIN 1103601

9 CORNER HINGE

CORNER HINGE K3 1083241

10 CORNER PIVOT REST

CORNER PIVOT REST K3 1083247

11 MISHANDLING DEVICE

SASH PART 1093907
FRAME PART PAGE 141

12 STRIKERS

T&Ti STRIKER PAGE 137
STRIKER PAGE 139

13 COVER CAPS

ADJUSTABLE STAY BEARING PAGE 134
STAY ARM PAGE 134
CORNER HINGE PAGE 134
CORNER PIVOT REST PAGE 134
CORNER PIVOT REST - FLAT PAGE 134

¹⁾ MISHANDLING DEVICE NOT AVAILABLE

APPLICATION DIAGRAM

Sash rebate height (SRH) in mm

Sash rebate width (SRW) in mm

Glass mass [kg/m²]

- Impermissible size range
- 20 kg/m²
- 30 kg/m²
- 40 kg/m²
- 50 kg/m²
- 60 kg/m²
- 70 kg/m²

Conditions for the use of the application diagram:

- Bearing loads:
 - top hinge: 2374 N
 - bottom hinge: 2374 N
- The following values are to be observed with all window systems:
 - width/height ratio $Q_{B/H} \leq 1,5$
 - sash size $H_{max} \leq 3 \text{ m}^2$
 - glass deduction dim. CG: $\geq 28 \text{ mm}$
 - profile weight PG: $\leq 3,25 \text{ kg/m}$

* The application diagrams are generated according to IFT guidelines.





Product portfolio

Individual products
Detailed information

T&T ESPAGNOLETTE M

Centered / variable handle height

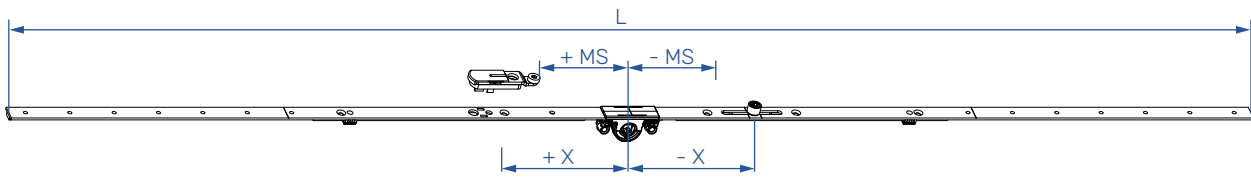

Backset 14,5 mm

SRH	HH	L	X	X	MS				PACK.	MATERIAL
420-660 ¹⁾	210-330	380	•	•	•	•	•	•	10	1083117
600-1000	300-500	720	-111	•	+ 38,5	1	2	2	10	1088473
900-1400	450-700	1120	-111	•	+ 99,5	1	5	5	10	1098964
1401-1800	701-900	1520	-111	•	+ 99,5	1	7	7	10	1098965
1601-2000	801-1000	1720	-311	+ 309	-121,5	2	8	8	10	1098966
2001-2400	1001-1200	2120	-311	+ 309	-121,5	2	10	10	10	1098967

SRH	HH	L	X	X	X	X	MS				PACK.	MATERIAL
900-1400	450-700	1120	•	-211	+ 209	•	+99,5	2	6	6	10	1098973
1401-1800	701-900	1520	•	-211	+ 209	•	+99,5	2	8	8	10	1098974
1601-2000	801-1000	1720	•	-311	+ 109	+ 559	-121,5	3	9	9	10	1098975
2001-2400	1001-1200	2120	-631	-311	+ 309	+ 629	-121,5	4	12	12	10	1098976

SRH	HH	L	X	X	MS				PACK.	MATERIAL
600-1000	300-500	720	-111	•	+ 38,5	1	2	2	10	1101035
900-1400	450-700	1120	-111	•	+ 99,5	1	5	5	10	1101036
1401-1800	701-900	1520	-111	•	+ 99,5	1	7	7	10	1101037
1601-2000	801-1000	1720	-311	+ 309	-121,5	2	8	8	10	1101038
2001-2400	1001-1200	2120	-311	+ 309	-121,5	2	10	10	10	1101039

SRH	HH	L	X	X	X	X	MS				PACK.	MATERIAL
900-1400	450-700	1120	•	-211	+ 209	•	+ 99,5	2	6	6	10	1105851
1401-1800	701-900	1520	•	-211	+ 209	•	+ 99,5	2	8	8	10	1105852
1601-2000	801-1000	1720	•	-311	+ 109	+ 559	-121,5	3	9	9	10	1105853
2001-2400	1001-1200	2120	-631	-311	+ 309	+ 629	-121,5	4	12	12	10	1105854

Backset 7,5 mm

SRH	HH	L	X	X	MS				PACK.	MATERIAL
470-820 ¹⁾	210-410	540	•	•	•	•	•	•	10	1083123
600-1000 ¹⁾	300-500	720	-111	•	•	1	2	2	10	1083124
900-1400	450-700	1120	-111	•	+ 99,5	1	5	5	10	1083125
1401-1800	701-900	1520	-111	•	+ 99,5	1	7	7	10	1083126
1601-2000	801-1000	1720	-311	+ 309	-121,5	2	8	8	10	1083127
2001-2400	1001-1200	2120	-311	+ 309	-121,5	2	10	10	10	1083128

¹⁾ MISHANDLING DEVICE NOT AVAILABLE

T&T ESPAGNOLETTE M - LARGER BACKSETS

Centered / variable handle height

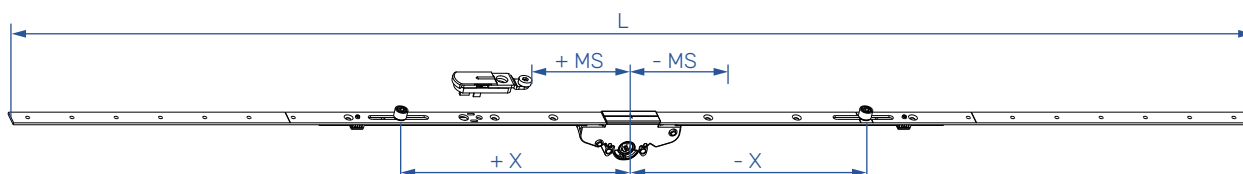

Backset 25 mm

SRH	HH	L	X	X	X	X	MS				PACK.	MATERIAL
420-660 ¹⁾	210-330	380	•	•	•	•	•	•	•	•	6	1104484
600-1000	300-500	720	•	•	-111	•	+38,5	1	2	6	6	1104485
900-1400	450-700	1120	•	+209	-211	•	+99,5	2	6	6	6	1104486
1401-1800	701-900	1520	•	+209	-211	•	+99,5	2	8	6	6	1104487
1601-2000	801-1000	1720	+559	+109	-311	•	-121,5	3	9	6	6	1104488
2001-2400	1001-1200	2120	+629	+309	-311	-631	-121,5	4	12	6	6	1104489

Backset 30 mm

SRH	HH	L	X	X	X	X	MS				PACK.	MATERIAL
420-660 ¹⁾	210-330	380	•	•	•	•	•	•	•	•	6	1107647
600-1000	300-500	720	•	•	-111	•	+38,5	1	2	6	6	1107648
900-1400	450-700	1120	•	+209	-211	•	+99,5	2	6	6	6	1107649
1401-1800	701-900	1520	•	+209	-211	•	+99,5	2	8	6	6	1107650
1601-2000	801-1000	1720	+559	+109	-311	•	-121,5	3	9	6	6	1107651
2001-2400	1001-1200	2120	+629	+309	-311	-631	-121,5	4	12	6	6	1107652

Backset 35 mm

SRH	HH	L	X	X	X	X	MS				PACK.	MATERIAL
420-660 ¹⁾	210-330	380	•	•	•	•	•	•	•	•	6	1107653
600-1000	300-500	720	•	•	-111	•	+38,5	1	2	6	6	1107654
900-1400	450-700	1120	•	+209	-211	•	+99,5	2	6	6	6	1107655
1401-1800	701-900	1520	•	+209	-211	•	+99,5	2	8	6	6	1107656
1601-2000	801-1000	1720	+559	+109	-311	•	-121,5	3	9	6	6	1107657
2001-2400	1001-1200	2120	+629	+309	-311	-631	-121,5	4	12	6	6	1107658

Backset 45 mm

SRH	HH	L	X	X	X	X	MS				PACK.	MATERIAL
420-660 ¹⁾	210-330	380	•	•	•	•	•	•	•	•	6	1104490
600-1000	300-500	720	•	•	-111	•	+38,5	1	2	6	6	1104491
900-1400	450-700	1120	•	+209	-211	•	+99,5	2	6	6	6	1104492
1401-1800	701-900	1520	•	+209	-211	•	+99,5	2	8	6	6	1104493
1601-2000	801-1000	1720	+559	+109	-311	•	-121,5	3	9	6	6	1104494
2001-2400	1001-1200	2120	+629	+309	-311	-631	-121,5	4	12	6	6	1104495

¹⁾ MISHANDLING DEVICE NOT AVAILABLE

T&T ESPAGNOLETTE M - LARGER BACKSETS + LOCKABLE

Centered / variable handle height

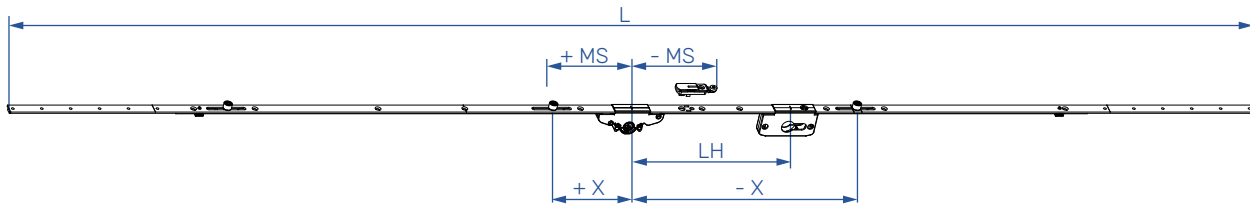

Backset 25 mm



SRH	HH	L	X	X	X	X	MS	LH			PACK.	MATERIAL
1601-2000	801-1000	1720	+559	+109	-311	•	-121,5	220	3	10	6	1104477
2001-2400	1001-1200	2120	+629	+309	-311	-631	-121,5	220	4	13	6	1104480

Backset 30 mm



SRH	HH	L	X	X	X	X	MS	LH			PACK.	MATERIAL
1601-2000	801-1000	1720	+559	+109	-311	•	-121,5	220	3	10	6	1107659
2001-2400	1001-1200	2120	+629	+309	-311	-631	-121,5	220	4	13	6	1107661

Backset 35 mm



SRH	HH	L	X	X	X	X	MS	LH			PACK.	MATERIAL
1601-2000	801-1000	1720	+559	+109	-311	•	-121,5	220	3	10	6	1107662
2001-2400	1001-1200	2120	+629	+309	-311	-631	-121,5	220	4	13	6	1107663

Backset 45 mm



SRH	HH	L	X	X	X	X	MS	LH			PACK.	MATERIAL
1601-2000	801-1000	1720	+559	+109	-311	•	-121,5	220	3	10	6	1104482
2001-2400	1001-1200	2120	+629	+309	-311	-631	-121,5	220	4	13	6	1104483

ESPAÑOLETE M

Centered / variable handle height

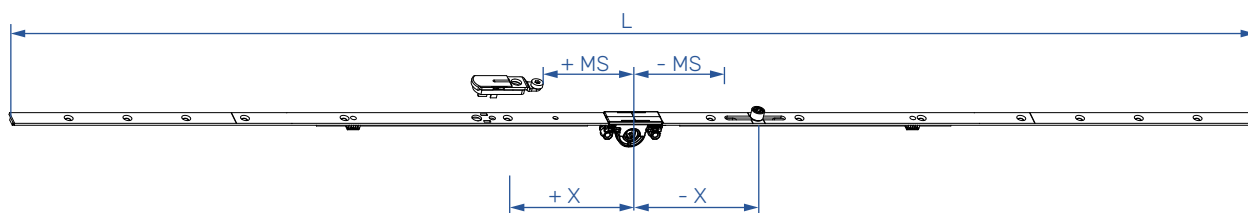

Backset 14,5mm

SRH	HH	L	X	X	X	X	MS			PACK.	MATERIAL
180-250 ¹⁾²⁾	90-125	180	•	- 65	•	•	•	1	2	20	1083163
251-500 ¹⁾	126-250	500	•	- 76	•	•	•	1	6	10	1083164
501-900	251-450	900	•	- 201	+ 199	•	- 128,5	2	12	10	1083165
901-1400	451-700	1400	•	- 401	+ 112	+ 399	- 128,5	3	16	10	1083166
1401-1900	701-950	1900	- 651	- 251	+ 249	+ 649	+ 89,5	4	20	10	1083167
1901-2400	951-1200	2400	- 901	- 351	+ 349	+ 899	+ 89,5	4	20	10	1083168

Backset 7,5 mm

SRH	HH	L	X	X	X	X	MS			PACK.	MATERIAL
251-500 ¹⁾	126-250	500	•	•	+ 74	•	•	1	6	10	1083169
501-900	251-450	900	•	- 201	+ 199	•	- 128,5	2	12	10	1083170
901-1400	451-700	1400	•	- 401	+ 112	+ 399	- 128,5	3	16	10	1083171
1401-1900	701-950	1900	- 651	- 251	+ 249	+ 649	+ 89,5	4	20	10	1083172
1901-2400	951-1200	2400	- 901	- 351	+ 349	+ 899	+ 89,5	4	20	10	1083173

¹⁾ MISHANDLING DEVICE NOT AVAILABLE

²⁾ HARDWARE SHORTENING NOT POSSIBLE

T&T ESPAGNOLETTE KV

Fixed handle height

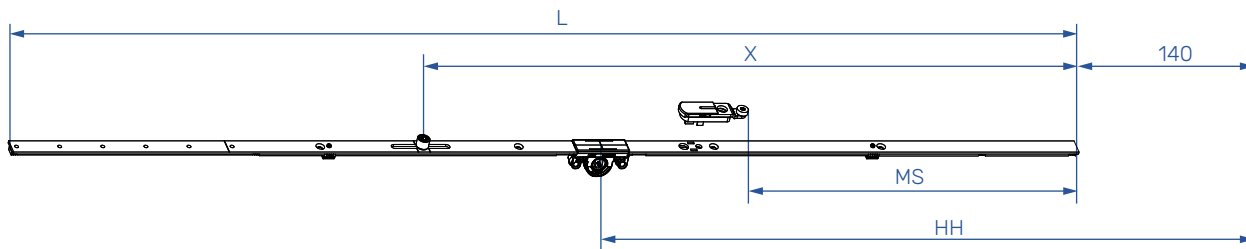

Backset 14,5 mm

SRH	HH	L	X	X	MS			PACK.	MATERIAL
320-460 ^{1) 3)}	120	320	•	•	•	•	1	10	1083081
320-460 ^{1) 2) 4)}	120	320	•	•	•	•	2	10	1105430
461-600 ⁵⁾	170	410	•	•	168	•	1	10	1118431
601-800	263	520	•	•	176	•	1	10	1115131
801-1000	413	720	•	•	145	•	3	10	1115132
801-1000	413	720	389	•	145	1	3	10	1115133
1001-1200	513	920	539	•	244	1	4	10	1115134
1201-1400	563	1120	539	•	244	1	6	10	1115135
1401-1600	563	1320	539	•	244	1	7	10	1115136
1601-1800	563	1520	539	•	244	1	8	10	1115137
1601-1800	1000	1520	539	•	244	1	8	10	1115167
1801-2000	1000	1720	1209	539	977	2	11	10	1115138
2001-2200	1000	1920	1209	539	977	2	12	10	1115139
2201-2400	1000	2120	1209	539	977	2	13	10	1115140

SRH	HH	L	X	X	MS			PACK.	MATERIAL
801-1000	413	720	389	•	145	1	3	10	1142916
1001-1200	513	920	539	•	244	1	4	10	1142919
1201-1400	563	1120	539	•	244	1	6	10	1142921
1401-1600	563	1320	539	•	244	1	7	10	1142922
1601-1800	563	1520	539	•	244	1	8	10	1142923
1601-1800	1000	1520	539	•	244	1	8	10	1142924
1801-2000	1000	1720	1209	539	977	2	11	10	1142925
2001-2200	1000	1920	1209	539	977	2	12	10	1142926
2201-2400	1000	2120	1209	539	977	2	13	10	1142927

¹⁾ MISHANDLING DEVICE NOT AVAILABLE

²⁾ WITH INTEGRATED CORNER DRIVE 1 RS

³⁾ SIDE TILT - T&T

⁴⁾ BOTTOM TILT - T&Ti

⁵⁾ MUST USE SHORT CORNER DRIVE ON BOTTOM











* T&T = WITH T&T LOCK BOLT











* T&Ti = WITH CORNER DRIVE 1 RS

T&T ESPAGNOLETTE KV

Fixed handle height

Backset 7,5 mm

									
SRH	HH	L	X	X	MS			PACK.	MATERIAL
320-460 ^{1) 2) 3)}	120	320	•	•	•	•	2	10	1083104
461-600 ⁴⁾	170	410	•	•	168	•	1	10	1144252
601-800	263	520	•	•	176	•	1	10	1144253
801-1000	413	720	•	•	145	•	3	10	1144254
801-1000	413	720	389	•	145	1	3	10	1144255
1001-1200	513	920	539	•	244	1	4	10	1144256
1201-1400	563	1120	539	•	244	1	6	10	1144257
1401-1600	563	1320	539	•	244	1	7	10	1144258
1601-1800	563	1520	539	•	244	1	8	10	1144259
1801-2000	1000	1720	1209	539	977	2	11	10	1144260
2001-2200	1000	1920	1209	539	977	2	12	10	1144261
2201-2400	1000	2120	1209	539	977	2	13	10	1144262

									
SRH	HH	L	X	X	MS			PACK.	MATERIAL
801-1000	413	720	389	•	145	1	3	10	1144266
1001-1200	513	920	539	•	244	1	4	10	1144267
1201-1400	563	1120	539	•	244	1	6	10	1144268
1401-1600	563	1320	539	•	244	1	7	10	1144269
1601-1800	563	1520	539	•	244	1	8	10	1144270
1801-2000	1000	1720	1209	539	977	2	11	10	1144271
2001-2200	1000	1920	1209	539	977	2	12	10	1144272
2201-2400	1000	2120	1209	539	977	2	13	10	1144273

¹⁾ MISHANDLING DEVICE NOT AVAILABLE

²⁾ WITH INTEGRATED CORNER DRIVE 1 RS

³⁾ BOTTOM TILT - T&Ti

⁴⁾ MUST USE SHORT CORNER DRIVE ON BOTTOM

ESPAÑOLETE

Fixed handle height

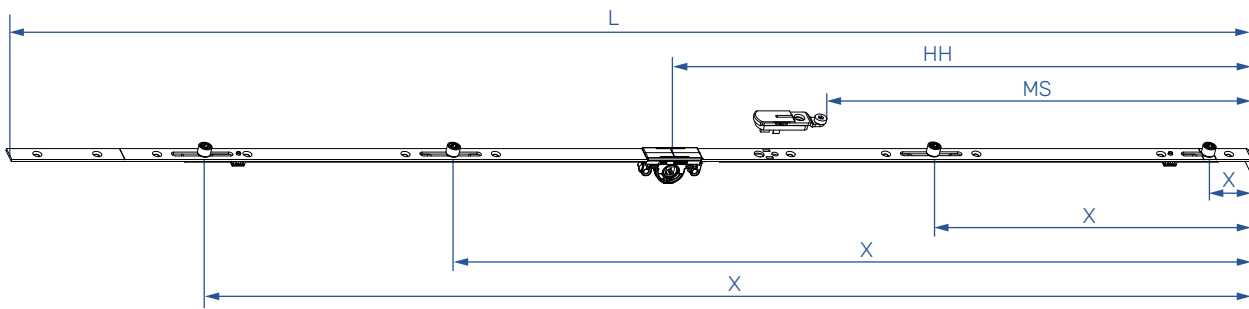

Backset 14,5 mm

SRH	HH	L	X	X	X	X	MS				PACK.	MATERIAL
400-500 ¹⁾	170	500	39	•	•	328	•	2	6	10	1083129	
501-600	170	600	39	•	•	428	219,5	2	7	10	1083130	
601-700	263	700	39	•	•	528	134,5	2	8	10	1083131	
701-800	263	800	39	•	•	628	134,5	2	9	10	1083132	
801-900	413	900	39	•	•	728	284,5	2	9	10	1083133	
901-1000	413	1000	39	•	•	828	284,5	2	9	10	1083134	
1001-1100	513	1100	39	•	708	928	384,5	2	10	10	1083135	
1101-1200	513	1200	39	•	708	1028	384,5	3	10	10	1083136	
1201-1300	563	1300	39	•	708	1128	384,5	3	11	10	1083137	
1301-1400	563	1400	39	•	708	1228	384,5	3	11	10	1083138	
1401-1500	563	1500	39	•	708	1328	384,5	3	11	10	1083139	
1501-1600	563	1600	39	•	708	1428	384,5	3	12	10	1083140	
1601-1700	563	1700	39	•	708	1528	384,5	3	12	10	1083141	
1701-1800	563	1800	39	708	1128	1628	384,5	4	14	10	1083142	
1801-2000	1000	2000	39	684	1278	1728	1117,5	4	15	10	1083143	
2001-2200	1000	2200	39	684	1328	1928	1117,5	4	15	10	1083144	
2201-2400	1000	2400	39	684	1528	2128	1117,5	4	17	10	1083145	

Backset 7,5 mm

SRH	HH	L	X	X	X	X	MS				PACK.	MATERIAL
400-500 ¹⁾	170	500	39	•	•	328	•	2	6	10	1083146	
501-600 ¹⁾	170	600	39	•	•	428	•	2	7	10	1083147	
601-700	263	700	39	•	•	528	134,5	2	8	10	1083148	
701-800	263	800	39	•	•	628	134,5	2	8	10	1083149	
801-900	413	900	39	•	•	728	284,5	2	8	10	1083150	
901-1000	413	1000	39	•	•	828	284,5	2	9	10	1083151	
1001-1100	513	1100	39	•	708	928	384,5	3	10	10	1083152	
1101-1200	513	1200	39	•	708	1028	384,5	3	10	10	1083153	
1201-1300	563	1300	39	•	708	1128	384,5	3	11	10	1083154	
1301-1400	563	1400	39	•	708	1228	384,5	3	11	10	1083155	
1401-1500	563	1500	39	•	708	1328	384,5	3	11	10	1083156	
1501-1600	563	1600	39	•	708	1428	384,5	3	12	10	1083157	
1601-1700	563	1700	39	•	708	1528	384,5	3	12	10	1083158	
1701-1800	563	1800	39	708	1128	1628	384,5	4	14	10	1083159	
1801-2000	1000	2000	39	684	1278	1728	1117,5	4	16	10	1083160	
2001-2200	1000	2200	39	684	1328	1928	1117,5	4	16	10	1083161	
2201-2400	1000	2400	39	684	1528	2128	1117,5	4	17	10	1083162	

¹⁾ MISHANDLING DEVICE NOT AVAILABLE

T&T ESPAGNOLETTE

Fixed handle height

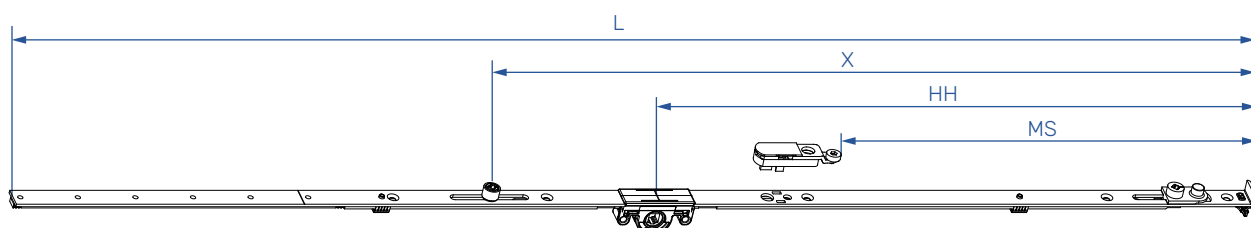

Backset 14,5 mm

SRH	HH	L	X	X	MS				PACK.	MATERIAL
320-460 ¹⁾	120	320	•	•	•	•	•	1* (0)	10	1083081
461-600	170	460	•	•	219,5	•	•	3* (2)	10	1083082
601-800	263	660	•	•	134,5	•	•	4* (3)	10	1083083
801-1000	413	860	•	•	284,5	•	•	5* (4)	10	1083084
801-1000	413	860	529	•	284,5	1	•	5* (4)	10	1083085
1001-1200	513	1060	679	•	384,5	1	•	6* (5)	10	1083086
1201-1400	563	1260	679	•	384,5	1	•	8* (7)	10	1083087
1401-1600	563	1460	679	•	384,5	1	•	9* (8)	10	1083088
1601-1800	563	1660	679	•	384,5	1	•	10* (9)	10	1083089
1601-1800	1000	1660	679	•	384,5	1	•	10* (9)	10	1083090
1801-2000	1000	1860	1349	679	1117,5	2	•	13* (12)	10	1083091
2001-2200	1000	2060	1349	679	1117,5	2	•	14* (13)	10	1083092
2201-2400	1000	2260	1349	679	1117,5	2	•	15* (14)	10	1083093

SRH	HH	L	X	X	X	MS				PACK.	MATERIAL
1201-1400	563	1260	910	679	•	384,5	2	9* (8)	10	1093878	
1401-1600	563	1460	1110	679	•	384,5	2	10* (9)	10	1093877	
1601-1800	563	1660	1110	679	•	384,5	2	11* (10)	10	1093874	
1801-2000	1000	1860	•	1349	679	1117,5	2	12* (11)	10	1083091	
2001-2200	1000	2060	1710	1349	679	1117,5	3	13* (12)	10	1093873	
2201-2400	1000	2260	1710	1349	679	1117,5	3	14* (13)	10	1093872	











SRH	HH	L	X	X	MS				PACK.	MATERIAL
801-1000	413	860	529	•	284,5	1	•	5* (4)	10	1101026
1001-1200	513	1060	679	•	384,5	1	•	6* (5)	10	1101027
1201-1400	563	1260	679	•	384,5	1	•	8* (7)	10	1101028
1401-1600	563	1460	679	•	384,5	1	•	9* (8)	10	1101029
1601-1800	563	1660	679	•	384,5	1	•	10* (9)	10	1101030
1601-1800	1000	1660	679	•	384,5	1	•	10* (9)	10	1101031
1801-2000	1000	1860	1349	679	1117,5	2	•	13* (12)	10	1101032
2001-2200	1000	2060	1349	679	1117,5	2	•	14* (13)	10	1101033
2201-2400	1000	2260	1349	679	1117,5	2	•	15* (14)	10	1101034

¹⁾ MISHANDLING DEVICE NOT AVAILABLE

* WITHOUT THE USE OF CENTER LOCK

(X) WITH THE USE OF CENTER LOCK

Backset 7,5 mm

 SRH	 HH	 L	 X	 X	 MS			 PACK.	 MATERIAL
330-460 ¹⁾²⁾	120	320	•	•	•	•	1* (0)	10	1083104
461-600 ²⁾	170	460	•	•	•	•	3* (2)	10	1083105
601-800	263	660	•	•	134,5	•	4* (3)	10	1083106
801-1000	413	860	•	•	284,5	•	5* (4)	10	1083107
801-1000	413	860	529	•	284,5	1	5* (4)	10	1083108
1001-1200	513	1060	679	•	384,5	1	6* (5)	10	1083109
1201-1400	563	1260	679	•	384,5	1	8* (7)	10	1083110
1401-1600	563	1460	679	•	384,5	1	9* (8)	10	1083111
1601-1800	563	1660	679	•	384,5	1	10* (9)	10	1083112
1601-1800	1000	1660	679	•	384,5	1	10* (9)	10	1083113
1801-2000	1000	1860	1349	679	1117,5	2	13* (12)	10	1083114
2001-2200	1000	2060	1349	679	1117,5	2	14* (13)	10	1083115
2201-2400	1000	2260	1349	679	1117,5	2	15* (14)	10	1083116

¹⁾ WITH INTEGRATED CORNER DRIVE 1 RS

²⁾ MISHANDLING DEVICE NOT AVAILABLE

* WITHOUT THE USE OF CENTER LOCK

(X) WITH THE USE OF CENTER LOCK

REVERSE ACTION ESPAGNOLETTE

Fixed handle height

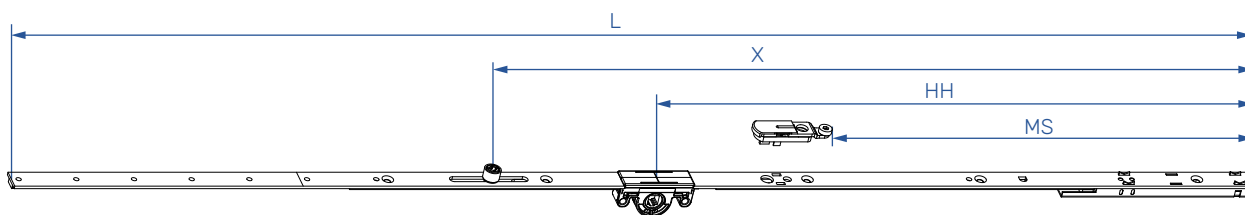

Backset 14,5 mm

SRH	HH	L	X	X	MS			PACK.	MATERIAL
440-600	170	460	•	•	•	•	2	10	1105363
601-800	263	660	•	•	134,5	•	4	10	1105364
801-1000	413	860	529	•	284,5	1	5	10	1105365
1001-1200	513	1060	679	•	384,5	1	6	10	1105366
1201-1400	563	1260	679	•	384,5	1	8	10	1105367
1401-1600	563	1460	679	•	384,5	1	8	10	1105368
1601-1800	563	1660	679	1349	384,5	2	10	10	1105369
1801-2000	1000	1860	679	1349	384,5	2	12	10	1105370
2001-2200	1000	2060	679	1349	384,5	2	13	10	1105371
2201-2400	1000	2260	679	1349	384,5	2	14	10	1105372

¹⁾ MISHANDLING DEVICE NOT AVAILABLE

²⁾ WITH INTEGRATED CORNER DRIVE 1 RS

FRENCH WINDOW ESPAGNOLETTE M

Centered / variable handle height

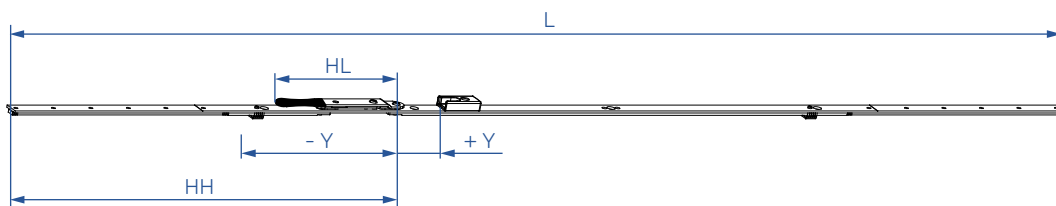

SRH	HH	L	Y ³⁾	Y	Y	Y ³⁾	HL	PACK.	BACKSET ²⁾	MATERIAL	
500-680 ¹⁾	290-380	400	•	•	•	•	2	130	10	14,5	1098116
600-1000 ¹⁾	387-586	720	•	- 189,5	•	•	3	130	10	14,5	1098120
800-1000 ¹⁾	587-686	720	•	- 289,5	•	•	3	130	10	7,5	1098121
900-1400	350-550	1120	•	+ 61,5	•	•	4	130	10	14,5/7,5	1098122
900-1400	350-550	1120	•	- 178,5	+ 241,5	•	4	130	10	14,5	1099308
1401-1800	350-550	1520	+ 161,5	+ 261,5	•	+ 581,5	6	130	10	14,5/7,5	1098123
1601-2000	350-550	1720	+ 581,5	+ 161,5	+ 781,5	+ 1031,5	8	130	10	14,5/7,5	1098124
2001-2400	350-550	2120	+ 41,5	+ 361,5	+ 981,5	+ 1301,5	10	130	10	14,5/7,5	1098125

¹⁾ MISHANDLING DEVICE NOT AVAILABLE

²⁾ T&T ESPAGNOLETTE M BACKSET COMPATIBLE

³⁾ FOR ADDITIONAL LOCKING CAM - INSTALL STRIKER **1100213**

• POSSIBLE FR. WIN. ESPAGNOLETTE BULLET CATCH

FRENCH WINDOW ESPAGNOLETTE KV

Fixed handle height

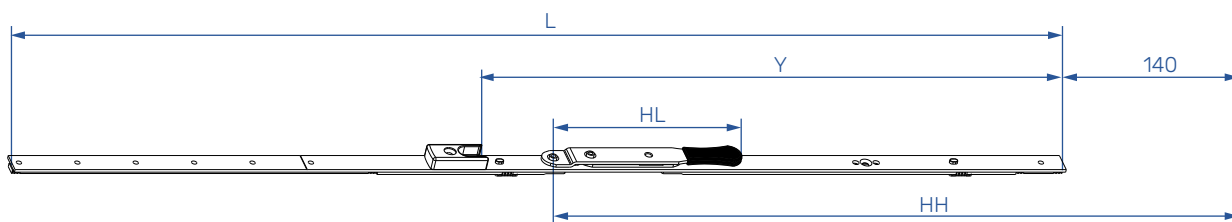

SRH	HH	L	Y	Y	HL	PACK.	MATERIAL
460-600 ^{1) 2)}	230	410	•	•	2	130	1118420
601-800 ²⁾	335	520	•	•	2	130	1118421
801-1000	490	720	397,5	•	3	130	1118423
1001-1200	335	920	547,5	•	4	130	1118424
1201-1400	335	1120	547,5	•	6	130	1118425
1401-1600	335	1320	547,5	•	7	130	1118426
1601-1800 •	335	1520	547,5	•	8	130	1118427
1801-2000 •	640	1720	547,5	1217,5	11	130	1118428
2001-2200 •	640	1920	547,5	1217,5	12	130	1118429
2201-2400 •	640	2120	547,5	1217,5	13	130	1118430

FRENCH WINDOW ESPAGNOLETTE T&T

Fixed handle height

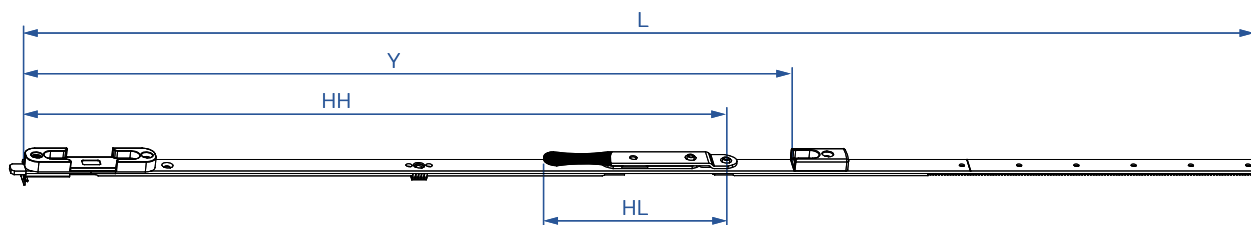

SRH	HH	L	Y	Y	HL	PACK.	MATERIAL
600-800 ²⁾	335	660	•	•	4*(3)	10	1083174
801-1000	490	860	536,5	•	4*(3)	10	1083175
1001-1200	335	1060	687,5	•	5*(4)	10	1083176
1201-1400	335	1260	687,5	•	8*(7)	10	1083177
1401-1600	335	1460	687,5	•	8*(7)	10	1083178
1601-1800 •	335	1660	687,5	•	9*(8)	10	1083179
1801-2000 •	640	1860	687,5	1357,5	10*(9)	10	1083180
2001-2200 •	640	2060	687,5	1357,5	11*(10)	10	1083181
2201-2400 •	640	2260	687,5	1357,5	12*(11)	10	1083182

¹⁾ MUST USE SHORT CORNER DRIVE ON BOTTOM

²⁾ MISHANDLING DEVICE NOT AVAILABLE

• POSSIBLE FR. WIN. ESPAGNOLETTE BULLET CATCH

* WITHOUT THE USE OF CENTER LOCK

(X) WITH THE USE OF CENTER LOCK

CORNER DRIVE

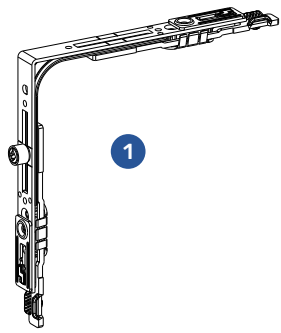

1

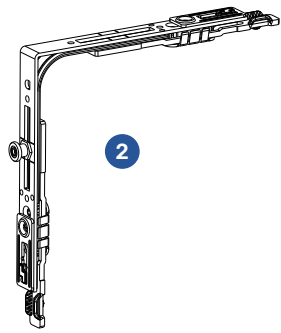

2

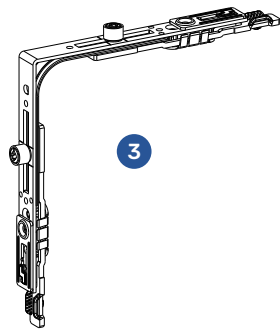

3

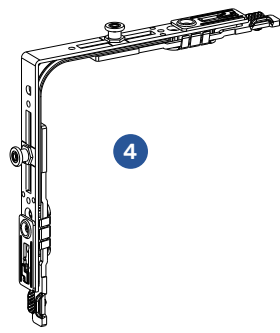

4

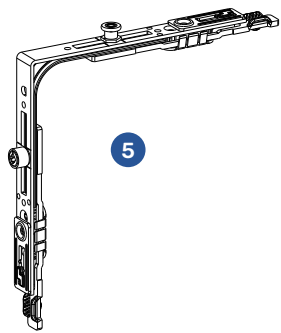

5

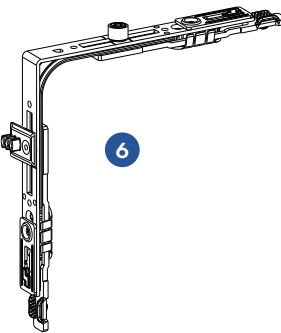

6

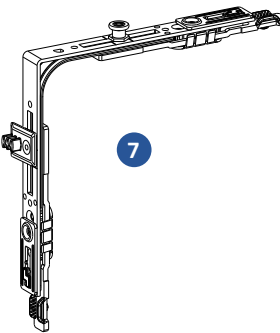

7

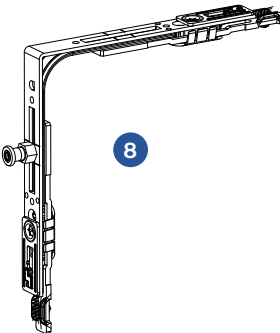

8

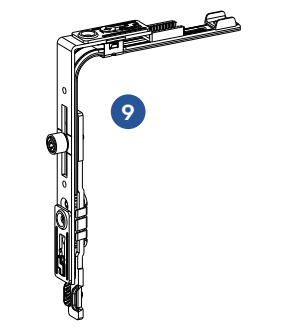

9

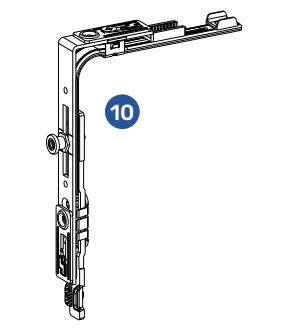

10

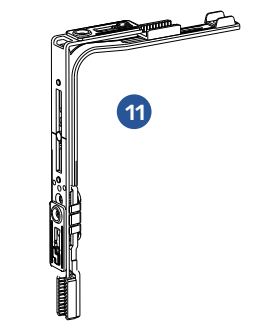

11



17

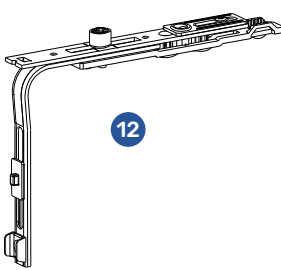

12

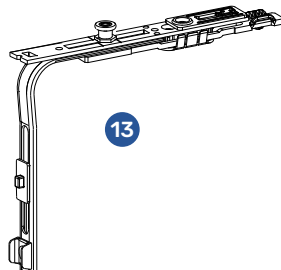

13

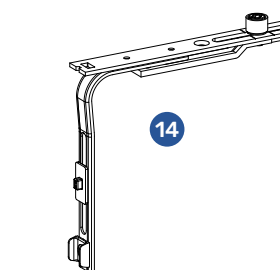

14

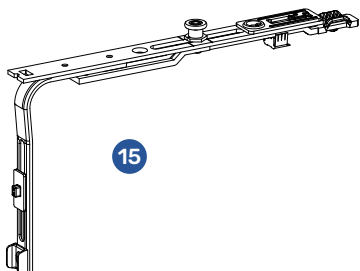

15

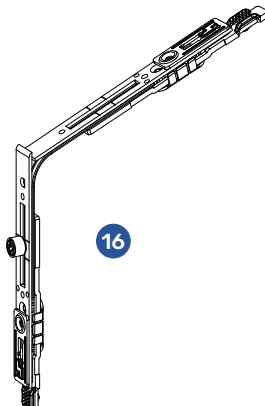

16

CORNER DRIVE



TYPE	DESCRIPTION	CAM				PACK.	MATERIAL	
1	Corner drive	1 R	1	•	4	10	1103158	
2	Corner drive	1 RS	1	•	4	10	1100983	
3	Corner drive	2 R	2	•	4	10	1103159	
4	Corner drive	2 RS	2	•	4	10	1100984	
5	Corner drive	1 R + 1 RS	2	•	4	10	1100985	
6	Corner drive	1 R + NV	R	1	1	4	10	1103160
6a	Corner drive	1 R + NV	L	1	1	4	10	1103165
7	Corner drive	1 RS + NV	R	1	1	4	10	1116988
7a	Corner drive	1 RS + NV	L	1	1	4	10	1116987
8*	Corner drive	1 RS LONG	1	•	4	10	1113170	
9	Short corner drive	1 R	1	•	3	10	1103162	
10	Short corner drive	1 RS	1	•	3	10	1100986	
11	Short corner drive	Shootbolt	1	•	3	10	1103161	
12	Corner lock 140	1 R	1	•	2	10	1103166	
13	T&Ti Corner lock 140 - SECURITY	1 RS	1	•	2	10	1100988	
14	Corner lock 180	1 R	1	•	2	10	1103164	
15	T&Ti Corner lock 180 - SECURITY	1 RS	1	•	2	10	1100987	
16	Corner drive - Pitched window	1 R	1	•	4	10	1103163	
17	Movement restrictor 90° for corner drive	•	•	•	1	100	1142599	

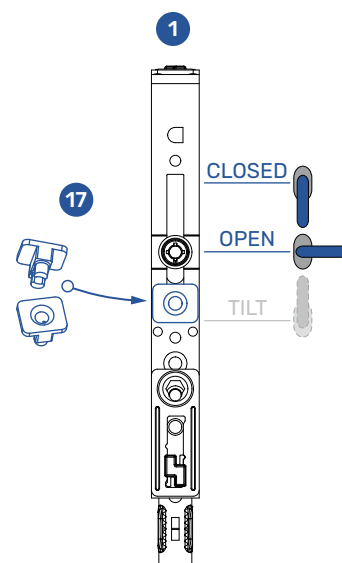
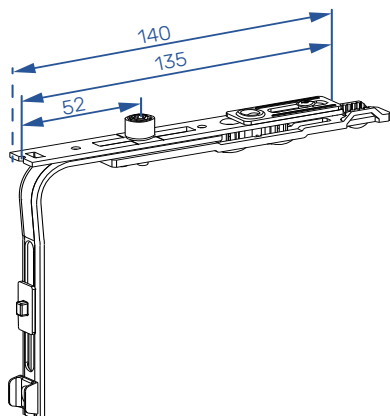
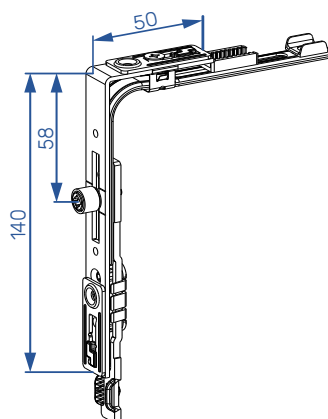
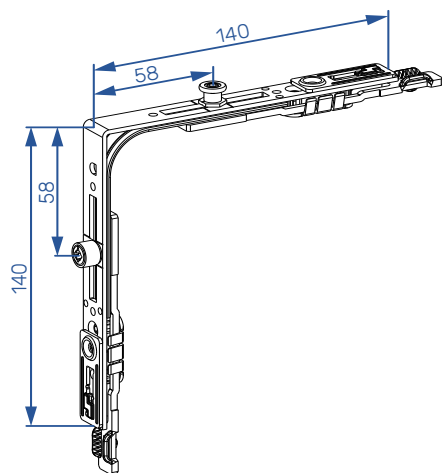





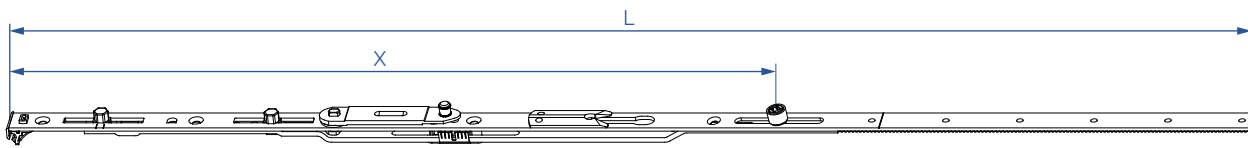



* FOR LOW THRESHOLD - USE IN COMBINATION WITH T&TI STRIKER 1116153

SASH-STAY GUIDE







Turn & tilt

SRW	L	X				
SRW	L	X			PACK.	MATERIAL
250-430 ¹⁾	150 / 290	•	•	2* (1)	10	1123308
411-610	250 / 470	•	•	3* (2)	10	1083038
611-810	350 / 670	•	•	5* (4)	10	1083039
811-1010	500 / 870	547	1	6* (5)	10	1083040
1011-1210	500 / 1070	608	1	8* (7)	10	1083041
1211-1400	500 / 1270	808	1	9* (8)	10	1083042

SRW	L	X				
SRW	L	X			PACK.	MATERIAL
811-1010	500 / 870	547	1	6* (5)	10	1100978
1011-1210	500 / 1070	608	1	8* (7)	10	1100980
1211-1410	500 / 1270	808	1	9* (8)	10	1100981

Turn only - SECOND SASH

SRW	L	X				
SRW	L	X			PACK.	MATERIAL
410-610	250 / 470	•	•	3* (2)	10	1105855
611-810	350 / 670	•	•	5* (4)	10	1105856
811-1010	500 / 870	547	1	6* (5)	10	1105857
1011-1211	350 / 670+400	547	2	8* (7)	10	1105856 + 1102897
1211-1400	500 / 870+400	547	2	9* (8)	10	1105857 + 1102897

¹⁾ SRW = 250 - 340 mm, WITH SHORT CORNER DRIVE





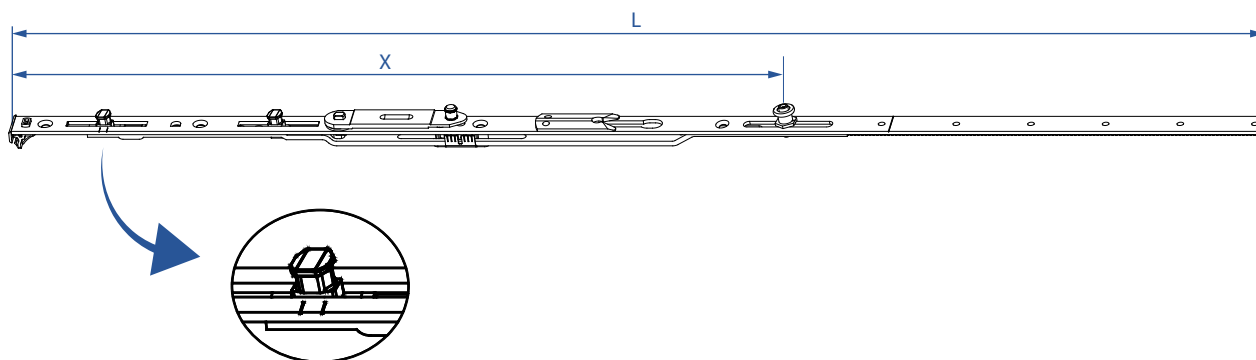

* WITHOUT THE USE OF CENTER LOCK

(X) WITH THE USE OF CENTER LOCK

* SRH < 500 mm, move the anti-slam device to reduce the tilt

Sash stay guide - additional security



 SRW	 L	 X			 PACK.	 MATERIAL
250-430 ¹⁾	150 / 290	•	•	2* (1)	10	1144882
411-610	250 / 470	•	•	3* (2)	10	1144883
611-810	350 / 670	•	•	5* (4)	10	1144884
811-1010	500 / 870	547	1	6* (5)	10	1144885
1011-1210	500 / 1070	608	1	8* (7)	10	1144886
1211-1400	500 / 1270	808	1	9* (8)	10	1144887

¹⁾ SRW = 250 - 340 mm, WITH SHORT CORNER DRIVE

* WITHOUT THE USE OF CENTER LOCK

(X) WITH THE USE OF CENTER LOCK

Stay arm

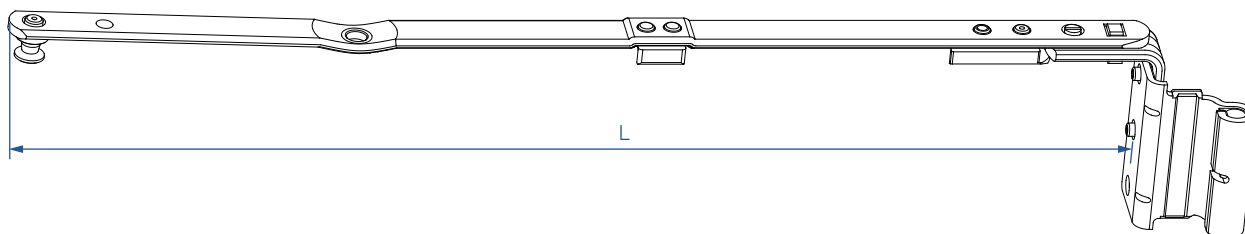

SYSTEM	SRW	L	POSITION	PACK.	MATERIAL
12/20-9	250-430 ¹⁾	150	L	10	1131552
	250-430 ¹⁾	150	R	10	1131553
	410-610	250	L	10	1083008
	410-610	250	R	10	1083009
	611-810	350	L	10	1083010
	611-810	350	R	10	1083011
	811-1400	500	L	10	1083012
	811-1400	500	R	10	1083013
12/20-13	250-430 ¹⁾	150	L	10	1123306
	250-430 ¹⁾	150	R	10	1123307
	410-610	250	L	10	1083016
	410-610	250	R	10	1083017
	611-810	350	L	10	1083018
	611-810	350	R	10	1083019
	811-1400	500	L	10	1083020
	811-1400	500	R	10	1083021
12/22-13	250-430 ¹⁾	150	L	10	1131554
	250-430 ¹⁾	150	R	10	1131555
	410-610	250	L	10	1083030
	410-610	250	R	10	1083031
	611-810	350	L	10	1083032
	611-810	350	R	10	1083033
	811-1400	500	L	10	1083034
	811-1400	500	R	10	1083035
TILT FIRST 12/20-13	320-610 ²⁾	250	L	10	1083025
	320-610 ²⁾	250	R	10	1083024
	611-810	350	L	10	1083027
	611-810	350	R	10	1083026
	811-1400	500	L	10	1083029
	811-1400	500	R	10	1083028

¹⁾ SRW = 250 - 340 mm, WITH SHORT CORNER DRIVE AND SASH STAY GUIDE 150 / 290

²⁾ SRW = 320 - 410 mm, WITH SHORT CORNER DRIVE AND SASH STAY GUIDE 250 / 470

Stay arm - additional security

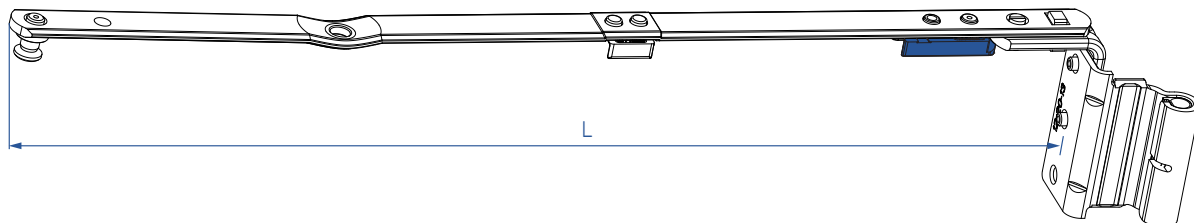

SYSTEM	SRW	L	POSITION	PACK.	MATERIAL
12/20-13	250-430 ¹⁾	150	L	10	1144380
	250-430 ¹⁾	150	R	10	1144381
	410-610	250	L	10	1144382
	410-610	250	R	10	1144383
	611-810	350	L	10	1144384
	611-810	350	R	10	1144385
	811-1400	500	L	10	1144386
	811-1400	500	R	10	1144387

¹⁾ SRW = 250 - 340 mm, WITH SHORT CORNER DRIVE AND SASH STAY GUIDE 150 / 290

STAY ARM

Rebate stay arm

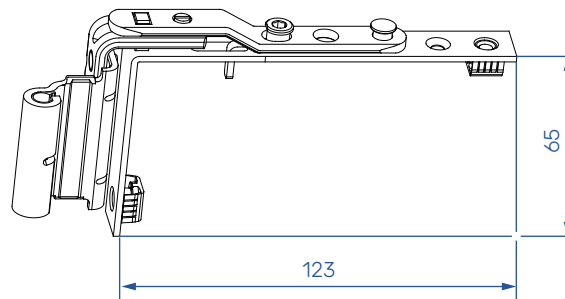

SYSTEM	POSITION		PACK.	MATERIAL
12/20-9	L	4	40	1083265
	R	4	40	1083264
12/20-13	L	4	40	1083263
	R	4	40	1083262
12/22-13	L	4	40	1083266
	R	4	40	1083267

Rebate stay arm - ALU

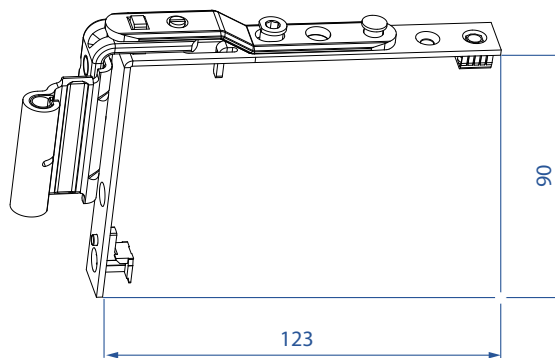

SYSTEM	POSITION		PACK.	MATERIAL
12/20-9	L	4	40	1146161
	R	4	40	1146162

STAY ARM

Tilt stay

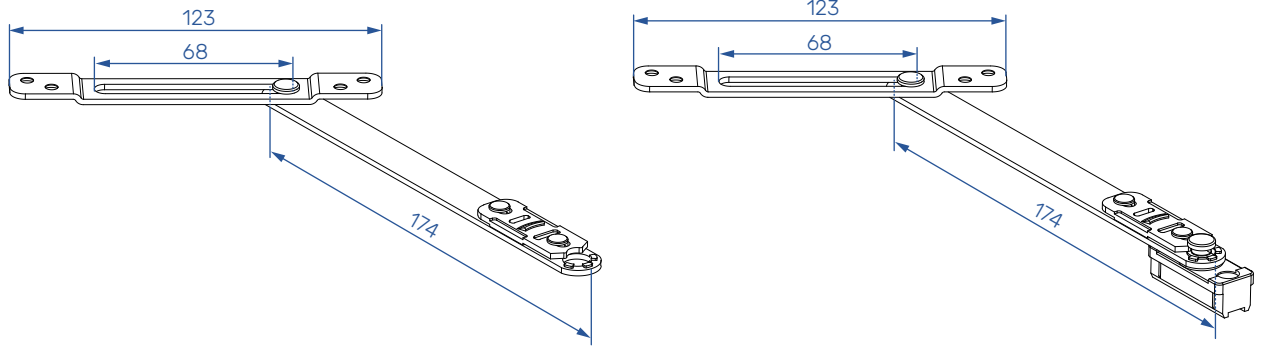

TYPE	DESCRIPTION		PACK.	MATERIAL
1	TILT STAY for espagnolette	5	100	1099152
2	TILT STAY for groove	7	100	1099154

Stay arm & lifter for arched / pitched window

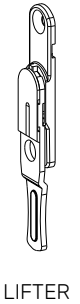
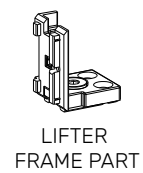
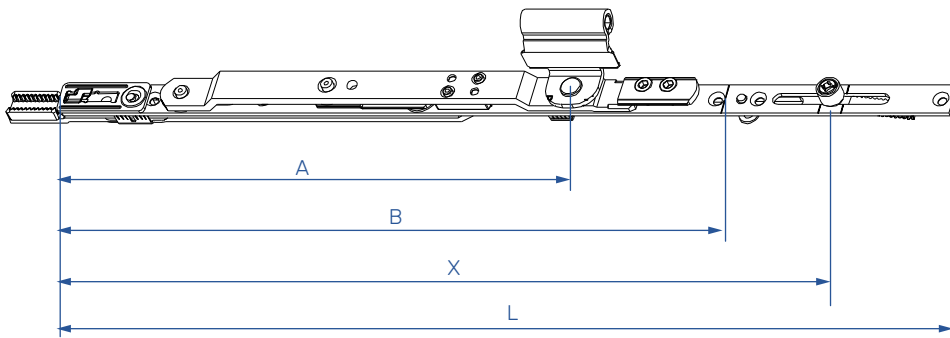

SYSTEM	L	X	A	B			PACK.	MATERIAL
12/20-9	430	372	249	320	1	1	10	1103144
12/20-13	430	372	249	320	1	1	10	1103147
12/22-13	430	372	249	320	1	1	10	1103148

CENTER LOCK

With guide

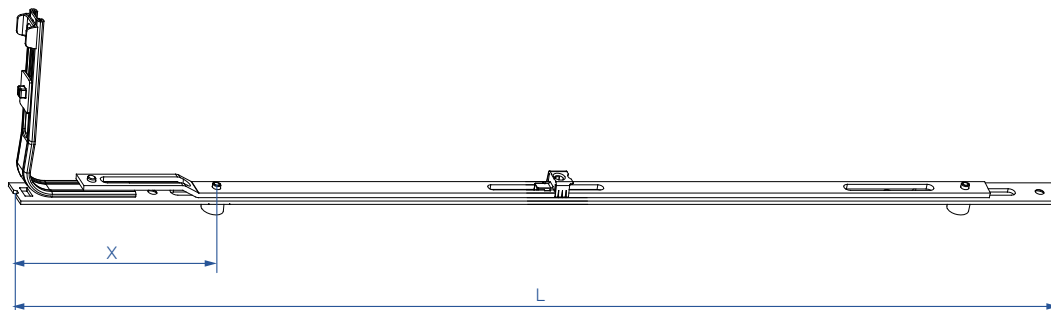

SRH	SRW	L	X	X	X	X			PACK.	MATERIAL
600-800	600-800	350	299	•	•	•	1	4	10	1093871
801-1200	801-1200	550	105	499	•	•	2	4	10	1083058
1201-1600	1201-1400	850	105	799	•	•	2	6	10	1083059
1601-2200	•	1550	105	799	1499	•	3	10	10	1083060
2201-2400	•	2000	105	799	1499	1949	4	11	10	1083064

SRH	SRW	L	X	X	X	X			PACK.	MATERIAL
801-1200	801-1200	550	105	499	•	•	2	4	10	1101000
1201-1600	1201-1400	850	105	799	•	•	2	6	10	1101002
1601-2200	•	1550	105	799	1499	•	3	10	10	1101003
2201-2400	•	2000	105	799	1499	1949	4	11	10	1101004

Without guide

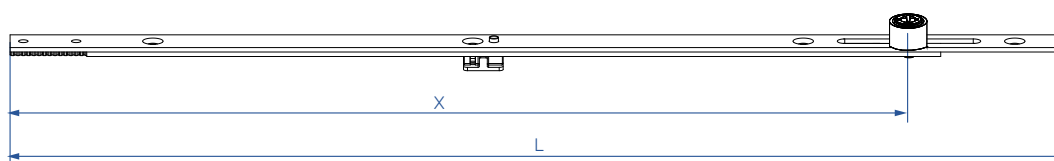

DESCRIPTION	L	X			PACK.	MATERIAL
400	400	339	1	4	10	1083061
600	600	539	1	4	10	1083062
600 coupling	600	539	1	4	10	1102900







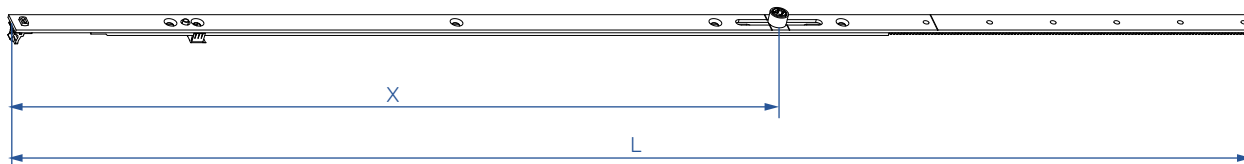

DESCRIPTION	L	X			PACK.	MATERIAL
200	200	139	1	2	10	1101005
400	400	339	1	4	10	1101006
400*	400	339	1	4	10	1121626
600	600	539	1	4	10	1101012
200 coupling	200	139	1	2	10	1101015
400 coupling	400	339	1	4	10	1101016
600 coupling	600	539	1	4	10	1101017

* FOR LOW THRESHOLD - USE IN COMBINATION WITH T&TI STRIKER 1116153

CENTER LOCK - ARCHED / PITCHED WINDOW







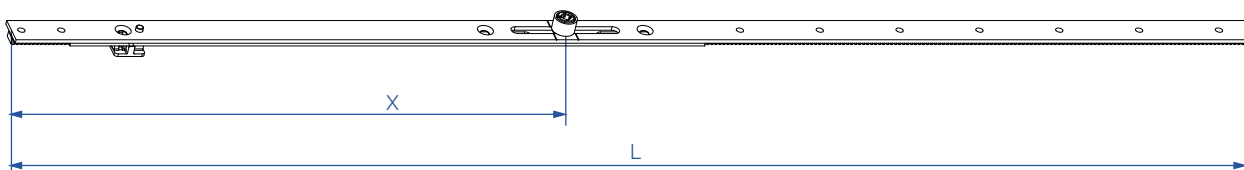

Vertical



 SRH	 L	 X	 X			 PACK.	 MATERIAL
491-700	380	•	•	•	2	10	1083071
701-900	580	281	•	1	4	10	1083072
901-1100	780	481	•	1	5	10	1083073
1101-1300	980	681	•	1	5	10	1083074
1301-1500	1180	281	881	2	7	10	1083075
1501-1700	1380	481	1081	2	8	10	1084924
1701-1900	1580	681	1281	2	8	10	1084925

Horizontal



 SRW	 L	 X	 X			 PACK.	 MATERIAL
400-650	370	•	•	•	1	10	1083076
651-900	620	276	•	1	3	10	1083077
901-1150	870	526	•	1	4	10	1083078
1151-1400	1120	276	776	2	6	10	1083079

CENTER LOCK - ARCHED / PITCHED WINDOW

Arched

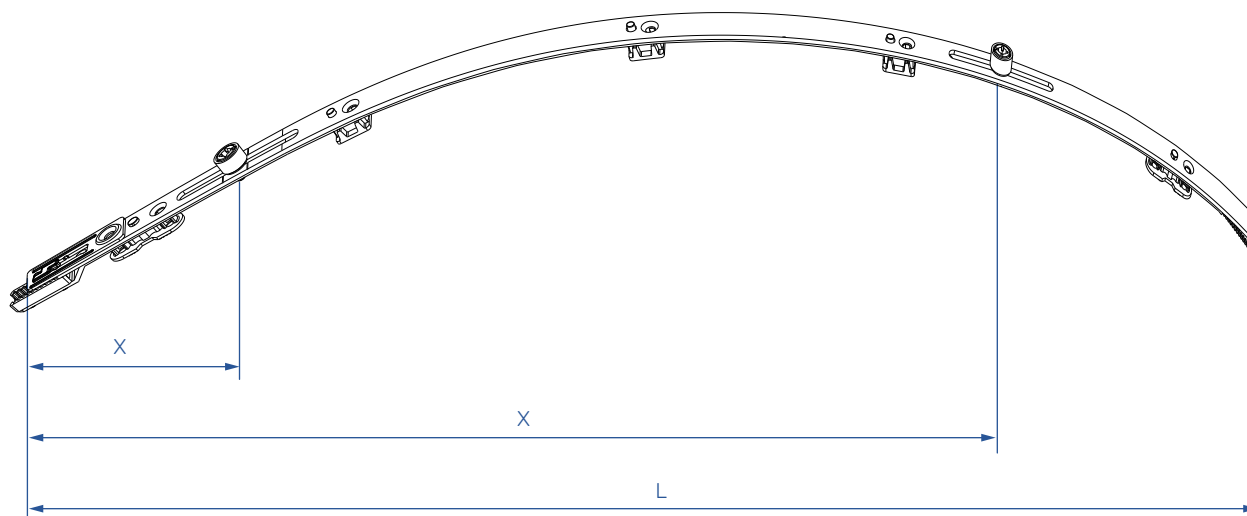







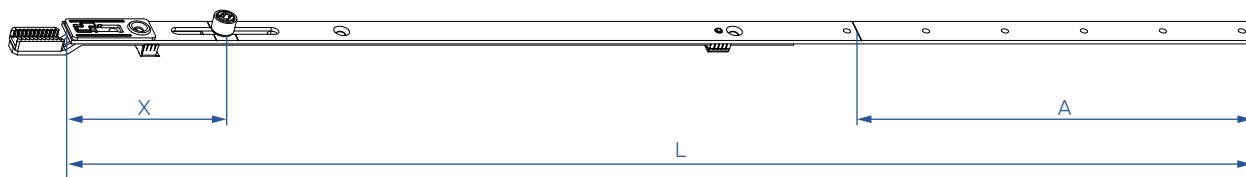

							
SRW	L	X	X			PACK.	MATERIAL
800-1400	590	79	429	2	6	10	1103143







* dimensions in table are given for a stretched / straight center lock (before bending)

ESPAGNOLETTE EXTENSION

Primary window







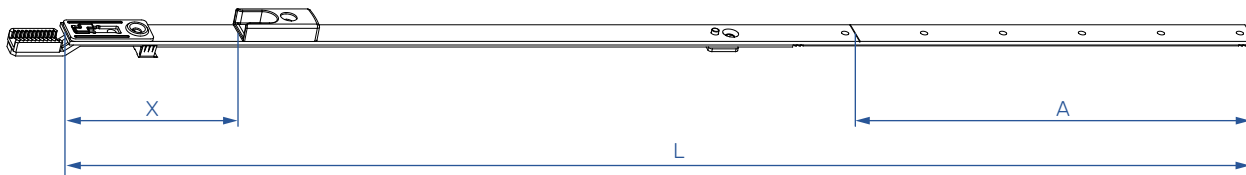

							
DESCRIPTION	A	L	X			PACK.	MATERIAL
400	200	400	79	1	3	10	1102897
600	200	600	79	1	4	10	1102898
800	200	800	79	1	5	10	1102899

							
DESCRIPTION	A	L	X			PACK.	MATERIAL
400	200	400	79	1	3	10	1137685
600	200	600	79	1	4	10	1140952
800	200	800	79	1	5	10	1144538

French window



							
DESCRIPTION	A	L	X			PACK.	MATERIAL
400	200	400	87,5	1	3	10	1105373
600	200	600	87,5	1	4	10	1105374

ESPAGNOLETTE EXTENSION

Lock bolt

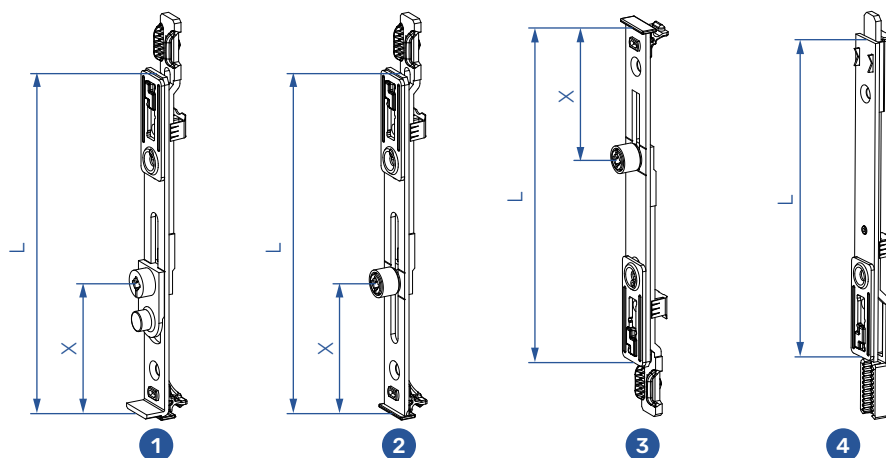

TYPE	DESCRIPTION	L		X	PACK.	MATERIAL
1	TILT LOCK BOLT < 1000	140	1	•	3* (2)	100 1102388
	TILT LOCK BOLT > 1001	140	1	•	3* (2)	100 1102391
2	TILT LOCK BOLT 140	140	•	1	53,5	3* (2) 100 1102394
3	TILT LOCK BOLT 140/90	140	•	1	53,5	3* (2) 100 1102395
4	EXT.FR.WIN.ESPAGNO. - 11 - TOP	140	•	•	•	3* (2) 50 1103211

* WITHOUT THE USE OF CENTER LOCK
(X) WITH THE USE OF CENTER LOCK

French window lock bolt

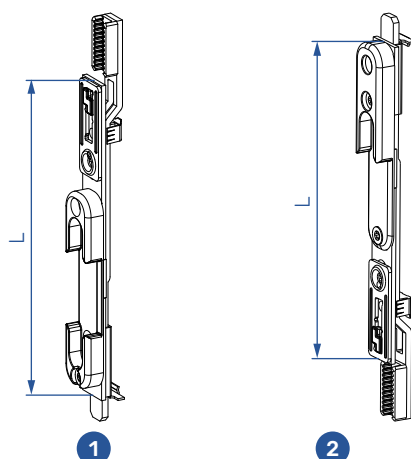

TYPE	DESCRIPTION	L	PACK.	MATERIAL
1	T&T EXT. FR. WIN. ESPAGNOLETTE M - 11 mm	140	3* (2)	50 1102621
2	EXT. FR. WIN. ESPAGNOLETTE - 11 mm - TOP	140	3* (2)	50 1110929

* WITHOUT THE USE OF CENTER LOCK
(X) WITH THE USE OF CENTER LOCK

SHOOTBOLT - OHG

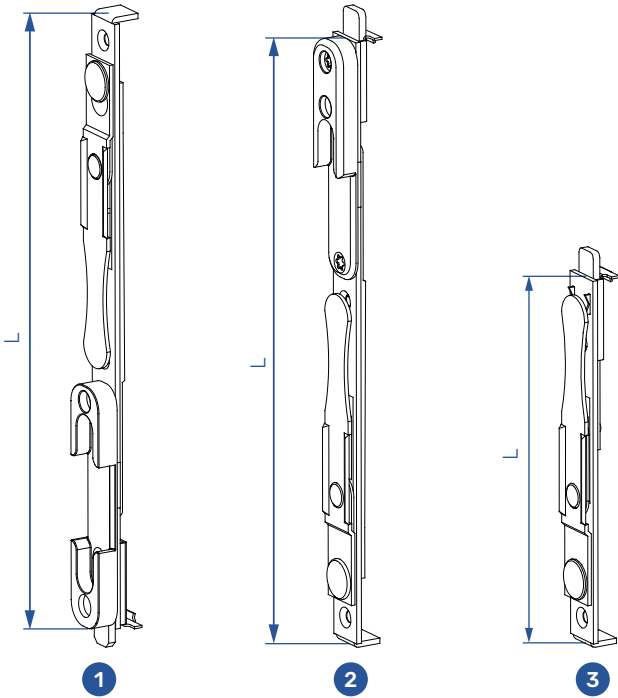

TYPE	DESCRIPTION	L			
1	T&T SHOOTBOLT - BOTTOM	230	3* (2)	50	1083252
2	SHOOTBOLT with STRIKER - TOP	230	3* (2)	50	1083253
3	SHOOTBOLT without STRIKER - TOP	140	2	100	1083254

* WITHOUT THE USE OF CENTER LOCK
 (X) WITH THE USE OF CENTER LOCK

CONCEALED HINGE SIDE

Affiliation by profiles

Affiliation by profiles

PROFILE	HINGE TYPE	PACKER
ALUPLAST 2000 / 3000	A	3 mm
ALUPLAST 4000 / 5000 / 6000 / 8000	A	5 mm
BRUGMANN BluEvolution	B	3 mm
GEALAN 7000/ 8000/ S9000	D	4 mm
PROFINE KBE 76/ 70AD	C	3 mm
PROFINE KÖMMERLING C70/ 76 MD	C	4 mm
PROFINE TROCAL 70.A5 AD/ 70.M5 MD/ 76 AD/ 76 MD	A	3 mm
REHAU Geneo/ Synego/ S706/ S730	A	4 mm
ROLOPLAST 7000/ 7500/ 7500 3D	C	4 mm
SCHÜCO Corona AD/ CT70 AD/ CT70 MD/ S182 MD	A	3 mm
SELECTA Advance 70	C	4 mm
VEKA Matrix/ Softline/ Softline 82/ Topline	B	3 mm
WEISS WP3000/ WP4000/ WP5000	A	3 mm
WHS Halo System 10	A	5 mm

* select hinges and packers according to the table

CONCEALED HINGE SIDE

Sash stay guide

Standard

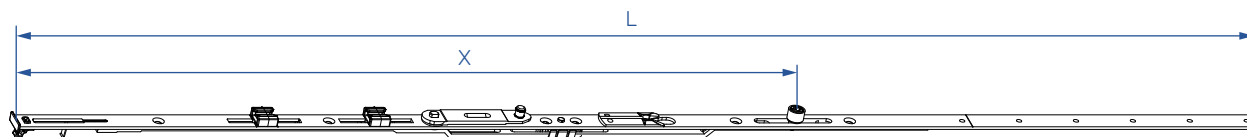

SRW	L	X	(R)			PACK.	MATERIAL
380-610 ¹⁾	170 / 470	•	•	3	10	1136634	
611-810	170 / 670	•	•	4	10	1136635	
811-1010	350 / 870	546	1	6	10	1136636	
1011-1210	350 / 1070	607	1	7	10	1136637	
1211-1400	500 / 1270	807	1	9	10	1136638	

SRW	L	X	(RS)			PACK.	MATERIAL
811-1010	350 / 870	546	1	6	10	1147277	
1011-1210	350 / 1070	607	1	7	10	1147278	
1211-1400	500 / 1270	807	1	9	10	1147279	

Tilt first

SRW	L	X	(R)			PACK.	MATERIAL
380-610 ¹⁾	170 / 470	•	•	3	10	1136158	
611-810	170 / 670	•	•	4	10	1136159	
811-1010	350 / 870	546	1	6	10	1136160	
1011-1210	350 / 1070	607	1	7	10	1136161	
1211-1400	500 / 1270	807	1	9	10	1136162	

¹⁾ SRW = 380 - 470 mm, WITH SHORT CORNER DRIVE

* SRH < 500 mm, move the anti-slam device to reduce the tilt

CONCEALED HINGE SIDE

Hinge side - UP

Stay arm

ONLY 12/20-13

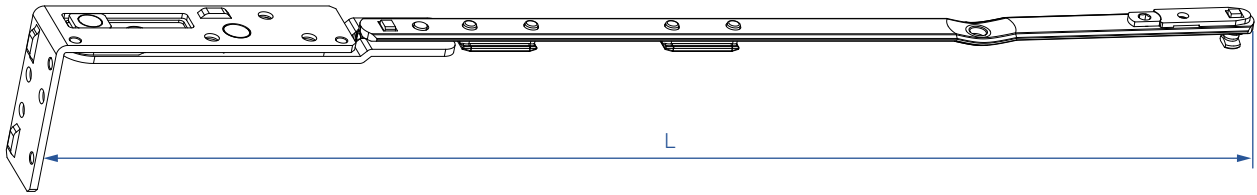

TYPE	SRW	L	POSITION		PACK.	TILT FIRST	TURN FIRST
A	380-810 ¹⁾	170	L		10	1136152	1136871
	380-810 ¹⁾	170	R		10	1136153	1136872
	811-1210	350	L		10	1136154	1136873
	811-1210	350	R		10	1136155	1136874
	1211-1400	500	L		10	1136156	1136875
	1211-1400	500	R		10	1136157	1136876
B	380-810 ¹⁾	170	L		10	1136392	1136877
	380-810 ¹⁾	170	R		10	1136393	1136878
	811-1210	350	L		10	1136394	1136879
	811-1210	350	R		10	1136395	1136880
	1211-1400	500	L		10	1136396	1136881
	1211-1400	500	R		10	1136397	1136882
C	380-810 ¹⁾	170	L		10	1136398	1136883
	380-810 ¹⁾	170	R		10	1136399	1136884
	811-1210	350	L		10	1136400	1136885
	811-1210	350	R		10	1136401	1136886
	1211-1400	500	L		10	1136402	1136887
	1211-1400	500	R		10	1136403	1136888
D	380-810 ¹⁾	170	L		10	1136404	1136889
	380-810 ¹⁾	170	R		10	1136405	1136890
	811-1210	350	L		10	1136406	1136891
	811-1210	350	R		10	1136407	1136892
	1211-1400	500	L		10	1136408	1136893
	1211-1400	500	R		10	1136409	1136894

¹⁾ SRW = 380 - 470 mm, WITH SHORT CORNER DRIVE AND SASH STAY GUIDE 170 / 470

* select packer - page 131

* select type according to the table - page 126





CONCEALED HINGE SIDE

Hinge side - UP

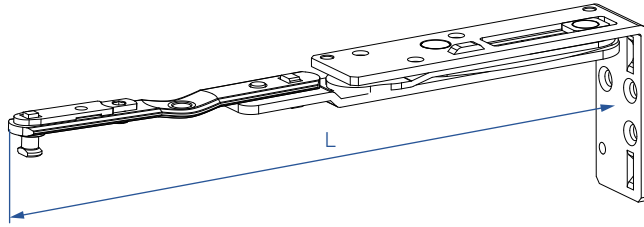
Rebate stay arm

ONLY 12/20-13



					
TYPE	L	POSITION		PACK.	MATERIAL
A	250	L	6	10	1141493
	250	R	6	10	1141492
B	250	L	6	10	1141499
	250	R	6	10	1141494
C	250	L	6	10	1141502
	250	R	6	10	1141500
D	250	L	6	10	1141504
	250	R	6	10	1141503

Rebate stay arm guide

ONLY 12/20-13

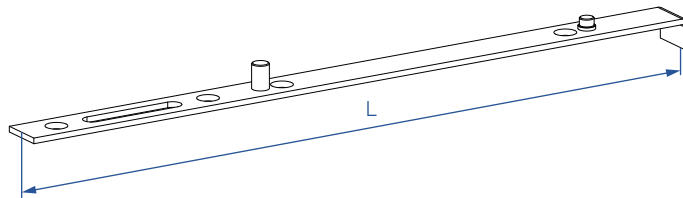

				
DESCRIPTION	L		PACK.	MATERIAL
REBATE STAY ARM GUIDE	260	4	10	1141516

* select packer - page 131

* select type according to the table - page 126

CONCEALED HINGE SIDE

Hinge side - DOWN

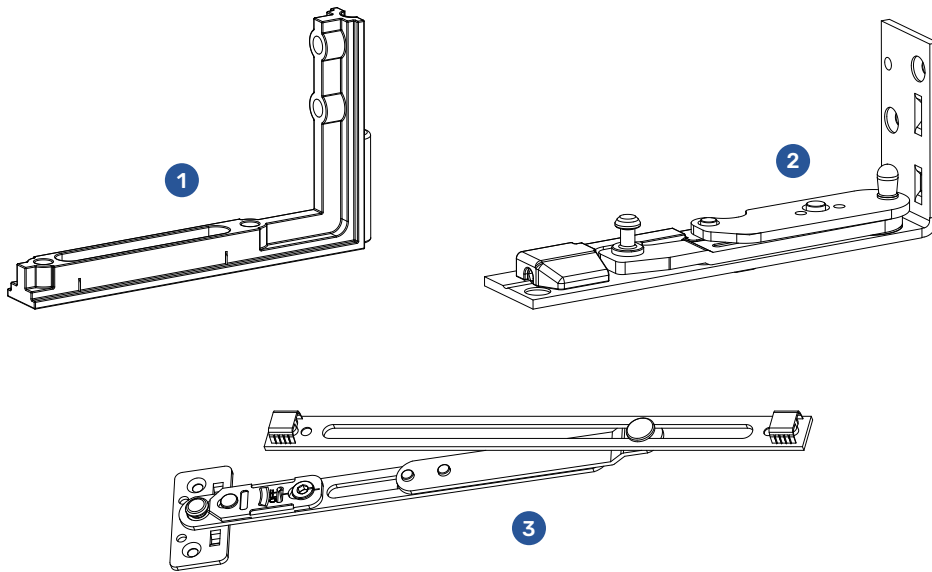

TYPE	DESCRIPTION	POS.	PACK.	MATERIAL
1	CORNER HINGE	L / R	40	1136163
2	CORNER PIVOT A	L	50	1136164
		R	50	1136165
	CORNER PIVOT B	L	50	1136410
		R	50	1136411
	CORNER PIVOT C	L	50	1136412
		R	50	1136413
	CORNER PIVOT D	L	50	1136414
		R	50	1136415
3*	SASH TURN LIMITER	L / R	100	1136166

* SRW 650 < Sash turn limiter

* select corner pivot and sash turn limiter packer - page 131

* select corner pivot type according to the table - page 126

CONCEALED HINGE SIDE

Hinge side - PACKERS

Stay arm

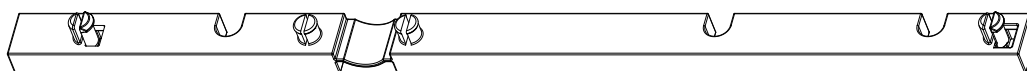

PACKER	POS.	MATERIAL
STAY ARM 3 mm	R	1136676
	L	1136677
STAY ARM 4 mm	R	1136674
	L	1136675
STAY ARM 5 mm	R	1135662
	L	1135663

Corner pivot

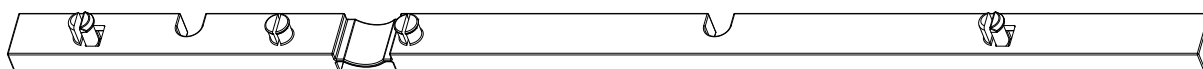

PACKER	POS.	MATERIAL
CORNER PIVOT REST 3 mm	R	1136683
	L	1136682
CORNER PIVOT REST 4 mm	R	1136679
	L	1136678
CORNER PIVOT REST 5 mm	R	1135665
	L	1135664

Turn limiter

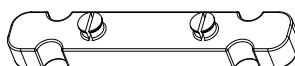

PACKER	POS.	MATERIAL
TURN LIMITER 3 mm	L / R	1136685
TURN LIMITER 4 mm	L / R	1136684
TURN LIMITER 5 mm	L / R	1135667

* select packer according to the table - page 126

FACE-FIT HINGE SIDE

Hinge side - UP

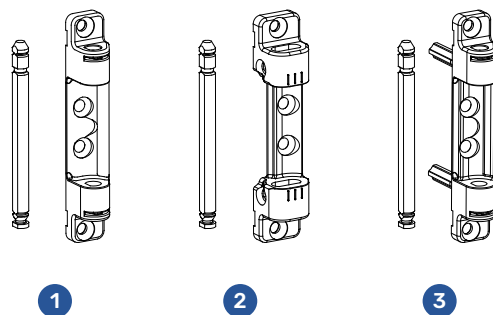

TYPE	DESCRIPTION	POS.		PACK.	MATERIAL
1	SASH STAY BEARING K3	L / R	4	100	1083250
2	SASH STAY BEARING K3 - adjustable	L / R	4	100	1103601
3	SASH STAY BEARING K6	L / R	4	100	1105598

FACE-FIT HINGE SIDE

Hinge side - BOTTOM / SIDE

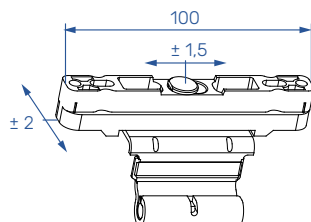

DESCRIPTION	POS.		PACK.	MATERIAL
REBATE CENTER HINGE 12/18-9 - adjustable	L / R	4	50	1104760
REBATE CENTER HINGE 12/18-13 - adjustable	L / R	4	50	1104762
REBATE CENTER HINGE 12/20-9 - adjustable	L / R	4	50	1083269
REBATE CENTER HINGE 12/20-13 - adjustable	L / R	4	50	1083268
REBATE CENTER HINGE 12/22-13 - adjustable	L / R	4	50	1083270

NUMBER OF REBATE CENTER HINGES ACCORDING TO SASH REBATE WIDTH

TILT ONLY WINDOW - SRW	NR. OF HINGES
< 1200	2
1201 - 2200	3
2201 - 2400	4

FACE-FIT HINGE SIDE

Hinge side - DOWN

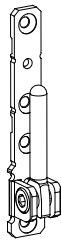

1

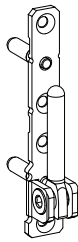

2



3

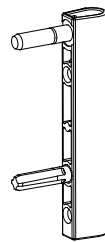

4

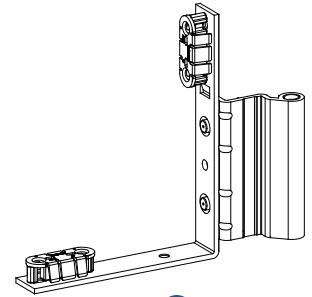

5



TYPE	DESCRIPTION	POS.		PACK.	MATERIAL
1	CORNER PIVOT REST K3	L / R	4	200	1083247
2	CORNER PIVOT REST K6	L / R	4	150	1105596



TYPE	DESCRIPTION	POS.		PACK.	MATERIAL
3	CORNER HINGE K3	L / R	2	200	1083241
	CORNER HINGE K3 - adjustable	L / R	2	200	1083243
4	CORNER HINGE K6	L / R	2	200	1083242



TYPE	DESCRIPTION	POS.		PACK.	MATERIAL
	REBATE CORNER HINGE 12/18-9	L	6	40	1101236
		R	6	40	1101237
	REBATE CORNER HINGE 12/18-13	L	6	40	1101242
		R	6	40	1101243
5	REBATE CORNER HINGE 12/20-9	L	6	40	1101239
		R	6	40	1101241
	REBATE CORNER HINGE 12/20-13	L	6	40	1101244
		R	6	40	1101245
	REBATE CORNER HINGE 12/22-13	L	6	40	1105922
		R	6	40	1105923

COVER CAPS

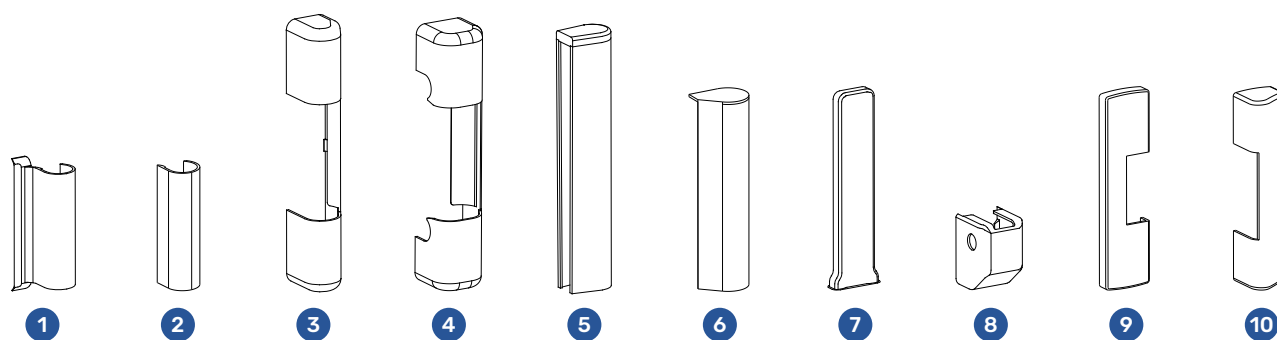

TYPE	DESCRIPTION	RAL	POS.	PACK.	MATERIAL
1	COVER CAP STAY ARM	RAL9016 - White		400	1127415
		RAL8019 - Greybrown		400	1127416
		RAL9005 - Black		400	1127417
		RAL9001 - Cream White		400	1127418
		RAL7016 - Anthracite grey		400	1134364
		SILVER		400	1127425
		DARK BRONZE		400	1127424
		TITANmat		400	1127423
		GOLDshine		400	1127426
		GOLDmat		400	1135425
2	COVER CAP STAY ARM 2	RAL9016 - White		500	1127419
		RAL8019 - Greybrown		500	1127420
		RAL9005 - Black		500	1127421
		RAL9001 - Cream White		500	1127422
		RAL 7016 - Anthracite grey		500	1141060
		SILVER		500	1127430
		DARK BRONZE		500	1127428
		TITANmat		500	1127429
		GOLDshine		500	1127427
		GOLDmat		500	1141059
3	COVER CAP STAY BEARING	RAL9016 - White		100	1127402
		RAL8019 - Greybrown		100	1127403
		RAL9005 - Black		100	1127404
		RAL9001 - Cream White		100	1127405
		RAL7016 - Anthracite grey		100	1134361
		SILVER		100	1127412
		DARK BRONZE		100	1127410
		TITANmat		100	1127411
		GOLDshine		100	1127409
		GOLDmat		100	1135423
4	COVER CAP FOR ADJUSTABLE STAY BEARING	RAL9016 - White		200	1127406
		RAL8019 - Greybrown		200	1127407
		RAL9005 - Black		200	1127408
		RAL7016 - Anthracite grey		200	1134363
		SILVER		200	1127414
		GOLDshine		200	1127413
		GOLDmat		200	1135424
5	COVER CAP CORNER HINGE	RAL9016 - White		100	1127378
		RAL8019 - Greybrown		100	1127379
		RAL9005 - Black		100	1127380
		RAL9001 - Cream White		100	1127381
		RAL7016 - Anthracite grey		100	1134357
		SILVER		100	1127383
		DARK BRONZE		100	1127385
TITANmat		100	1127382		
GOLDshine		100	1127384		
GOLDmat		100	1135420		

COVER CAPS

6	COVER CAP REBATE CORNER HINGE	RAL9016 - White	L	200	1127493
			R	200	1127498
		RAL8019 - Greybrown	L	200	1127494
			R	200	1127499
		RAL9005 - Black	L	200	1127495
			R	200	1127500
		RAL9001 - Cream White	L	200	1127497
			R	200	1127502
		RAL7016 - Anthracite grey	L	200	1134365
			R	200	1134366
		SILVER	L	200	1127496
			R	200	1127501
		DARK BRONZE	L	200	1127505
			R	200	1127506
		TITANmat	L	200	1127504
			R	200	1127508
		GOLDshine	L	200	1127503
			R	200	1127507
		L	200	1135426	
		R	200	1135427	
7	COVER CAP CORNER PIVOT REST - flat	RAL9016 - White		500	1127390
		RAL8019 - Greybrown		500	1127391
		RAL9005 - Black		500	1127392
		RAL9001 - Cream White		500	1127393
		RAL7016 - Anthracite grey		500	1134359
		SILVER		500	1127400
		DARK BRONZE		500	1127398
		TITANmat		500	1127399
		GOLDshine		500	1127401
		GOLDmat		500	1135422
8	COVER CAP CORNER PIVOT REST	RAL9016 - White		300	1127386
		RAL8019 - Greybrown		300	1127387
		RAL9005 - Black		300	1127388
		RAL9001 - Cream White		300	1127389
		RAL7016 - Anthracite grey		300	1134358
		SILVER		300	1127394
		DARK BRONZE		300	1127395
		TITANmat		300	1127397
		GOLDshine		300	1127396
		GOLDmat		300	1135421
9	COVER CAP CENTER STRIKER - sash	RAL9016 - White		500	1127433
		RAL8019 - Greybrown		500	1127434
		SILVER		500	1127438
10	COVER CAP CENTER STRIKER - frame	RAL9016 - White		250	1127431
		RAL8019 - Greybrown		250	1127432
		SILVER		250	1127435

* COVER CAPS "RAL" ARE INJECTED

* COVER CAPS "COLOR" ARE COLORED

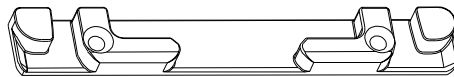

System 12/20-13

T&T STRIKER	PACK.	MATERIAL
ALPHACAN In Alpha/ 70	250	1083186
ALUPLAST 2000/ 3000/ 4000/ 5000/ 6000/ 8000	250	1083185
BRUGMANN BluEvolution	250	1083183
DECEUNINCK 2500/ 2800	250	1083187
EUROCELL Modus	250	1083186
GEALAN 7000/ 8000/ S9000	250	1083186
INOUTIC Prestige/ Arcade	250	1083187
INOUTIC Elegante	250	1131424
LINIAR	250	1097947
PESTAN S509	250	1083186
PIMAPEN Carisma S-7000	250	1131424
PROFINE KBE 76/ 70AD	250	1083186
PROFINE KÖMMERLING Eurofutur Classic/ Elegance/ 88 Plus/ C70/ 76 MD	250	1083186
PROFINE TROCAL 70.A5 AD/ 70.M5 MD/ 76 AD/ 76 MD	250	1083186
REHAU Geneo/ Synego/ S706/ S730/ System 4500/ Brilliant	250	1083185
ROLOPLAST 7000/ 7500/ 7500 3D	250	1083185
ROPLASTO 7001 AD	250	1083185
SALAMANDER 3D/ Streamline 76	250	1083185
SCHÜCO Corona AD/ CT70 AD/ CT70 MD/ S182 MD	250	1083185
SELECTA Advance 70	250	1083186
VEKA Matrix/ Softline/ Softline 82/ Topline	250	1083183
VUJIC 7000/ 8000	250	1097947
WEISS WP3000/ WP4000/ WP5000	250	1083185
WHS Halo System 10	250	1083185

System 12/20-9

T&T STRIKER	PACK.	MATERIAL
PROFINE KBE AD9	250	1083189

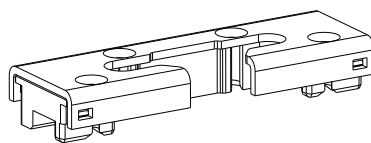

System 12/20-13



T&TI STRIKER	POS.	PACK.	MATERIAL
ALUPLAST 2000/ 3000	R	100	1132249
	L		1132250
ALUPLAST 4000/ 5000/ 6000/ 8000	R	100	1132233
	L		1132234
BRUGMANN BluEvolution	R	100	1132249
	L		1132250
DECEUNINCK 2500/ 2800	R	100	1132245
	L		1132246
EUROCELL Modus	R	100	1132235
	L		1132236
GEALAN 7000/ 8000 /S9000	R	100	1132235
	L		1132236
INOUTIC Prestige/ Arcade	R	100	1132245
	L		1132246
INOUTIC Elegante	R	100	1135570
	L		1135571
LINIAR	R	100	1132249
	L		1132250
PIMAPEN Carisma S-7000	R	100	1135570
	L		1135571
PROFINE KBE 76/ 70AD	R	100	1132235
	L		1132236
PROFINE KÖMMERLING Eurofutur Clasic/ Elegance/ 88 Plus	R	100	1132239
	L		1132240
PROFINE KÖMMERLING C70/ 76 MD	R	100	1132235
	L		1132236
PROFINE TROCAL 70.A5 AD/ 70.M5 MD/ 76 AD/ 76 MD	R	100	1132235
	L		1132236
REHAU S706/ S730/ System 4500/ Brilliant	R	100	1132241
	L		1132242
REHAU Geneo/ Synego	R	100	1139277
	L		1139278
ROLOPLAST 7000/ 7500/ 7500 3D	R	100	1132243
	L		1132244
SALAMANDER 3D/ Streamline 76	R	100	1132243
	L		1132244
SCHÜCO Corona AD/ CT70 AD/ CT70 MD/ S182 MD	R	100	1132231
	L		1132232
SELECTA Advance 70	R	100	1132235
	L		1132236
VEKA Matrix/ Softline/ Softline 82/ Topline	R	100	1132249
	L		1132250
WEISS WP3000/ WP4000/ WP5000	R	100	1132231
	L		1132232
WHS Halo System 10	R	100	1132233
	L		1132234

System 12/20-9



T&TI STRIKER	PACK.	MATERIAL
PROFINE KBE AD9	100	1083193

T&TI STRIKER - TILT FIRST

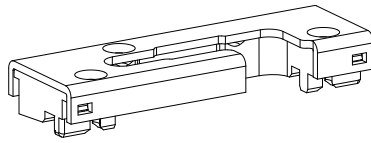

System 12/20-13



T&TI STRIKER - TILT FIRST	POS.	PACK.	MATERIAL
ALUPLAST 2000 / 3000	L	100	1107730
	R		1107729
ALUPLAST 4000 / 5000/ 6000 / 8000	L	100	1107728
	R		1107727
BRUGMANN BluEvolution	L	100	1107732
	R		1107731
EUROCELL Modus	L	100	1107667
	R		1107666
LINIAR	L	100	1107732
	R		1107731
PROFINE KBE 70AD	L	100	1107667
	R		1107666
PROFINE KÖMMERLING C70/ 76 MD	L	100	1107667
	R		1107666
REHAU S706/ S730/ System 4500/ Brilliant	L	100	1083817
	R		1083816
SELECTA Advance 70	L	100	1107667
	R		1107666
VEKA Matrix/ Softline/ Softline 82/ Topline	L	100	1107730
	R		1107729
WHS Halo System 10	L	100	1107728
	R		1107727

STRIKER

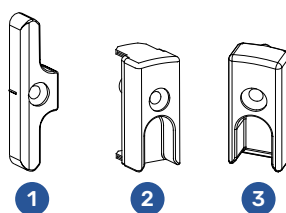

System 12/20-13

TYPE	STRIKER	PACK.	MATERIAL
	ALPHACAN In Alpha/ 70	300	1083205
	ALUPLAST 2000/ 3000/ 4000/ 5000/ 6000/ 8000	300	1083204
	BRUGMANN BluEvolution	300	1083202
	DECEUNINCK 2500/ 2800	300	1083206
	EUROCELL Modus	300	1107664
	GEALAN 7000/ 8000 /S9000	300	1083203
	INOUTIC Prestige/ Arcade	300	1083206
	INOUTIC Elegante	300	1131423
	LINIAR	300	1097948
	PIMAPEN Carisma S-7000	300	1131423
	PESTAN S509	300	1083205
1	PROFINE KBE 76/ 70AD	300	1083205
	PROFINE KÖMMERLING Eurofutur Clasic/ Elegance/ 88 Plus/ C70/ 76 MD	300	1083205
	PROFINE TROCAL 70.A5 AD/ 70.M5 MD/ 76 AD/ 76 MD	300	1083205
	REHAU Geneo/ Synego/ S706/ S730/ System 4500/ Brilliant	300	1083204
	ROLOPLAST 7000/ 7500/ 7500 3D	300	1083204
	ROPLASTO 7001 AD	300	1083204
	SALAMANDER 3D/ Streamline 76	300	1083204
	SCHÜCO Corona AD/ CT70 AD/ CT70 MD/ S182 MD	300	1083204
	SELECTA Advance 70	300	1083205
	VEKA Matrix/ Softline/ Softline 82/ Topline	300	1083202
	VUJIC 7000/8000	300	1097948
	WEISS WP3000/ WP4000/ WP5000	300	1083204
	WHS Halo System 10	300	1083204

System 12/20-9

TYPE	STRIKER	PACK.	MATERIAL
1	3/4 mm	300	1083209
	PROFINE KBE AD9	300	1083208

System independent

TYPE	SYSTEM INDEPENDENT STRIKERS	PACK.	MATERIAL
2	STRIKER OHG	300	1083207
3	FRENCH WINDOW ESPAGNOLETTE M - ADDITIONAL STRIKER	300	1100213

SECURITY STRIKER

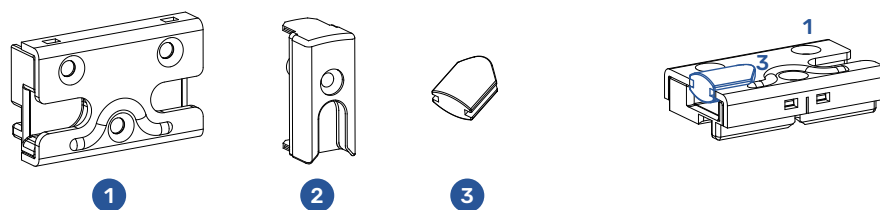

System 12/20-13

TYPE	SECURITY STRIKER	PACK.	MATERIAL
	ALUPLAST 2000/ 3000	100	1083219
	ALUPLAST 4000/ 5000/ 6000/ 8000	100	1083216
	BRUGMANN BluEvolution	100	1083214
	DECEUNINCK 2500/ 2800	100	1083218
	EUROCELL Modus	100	1083217
	GEALAN 7000/ 8000/ S9000	100	1083217
	INOUTIC Prestige/ Arcade	100	1083218
	INOUTIC Elegante	100	1135572
	LINIAR	100	1083214
	PIMAPEN Carisma S-7000	100	1135572
1	PROFINE KBE 76/ 70AD	100	1083217
	PROFINE KÖMMERLING Eurofutur Clasic/ Elegance/ 88 Plus	100	1098310
	PROFINE KÖMMERLING C70/ 76 MD	100	1083217
	PROFINE TROCAL 70.A5 AD/ 70.M5 MD/ 76 AD/ 76 MD	100	1083217
	REHAU S706/ S730/ System 4500/ Brilliant	100	1089625
	REHAU Geneo/ Synego	100	1139279
	ROLOPLAST 7000/ 7500/ 7500 3D	100	1098609
	SALAMANDER 3D/ Streamline 76	100	1098609
	SCHÜCO Corona AD/ CT70 AD/ CT70 MD/ S182 MD	100	1083219
	SELECTA Advance 70	100	1083217
	VEKA Matrix/ Softline/ Softline 82/ Topline	100	1083214
	WEISS WP3000/ WP4000/ WP5000	100	1083219
	WHS Halo System 10	100	1083216

System 12/20-9

TYPE	SECURITY STRIKER	PACK.	MATERIAL
1	PROFINE KBE AD9	100	1083220

System independent

TYPE	SYSTEM INDEPENDENT SECURITY STRIKER	PACK.	MATERIAL
2	SECURITY STRIKER OHG	100	1066042
3	GROOVE SPACER 12 mm for RC 1	500	1127521

* INSTALL GROOVE SPACER IN EVERY FREE SLOT ON SECURITY STRIKER (OPPOSITE OF THE LOCKING POINT). GROOVE SPACER IS NECESSARY FOR RC 1 SCHEME.

MISHANDLING DEVICE

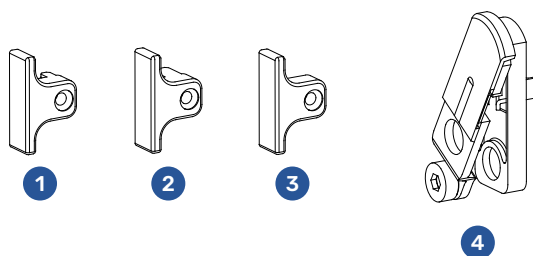

System 12/20-13

TYPE	MISHANDLING DEVICE - FRAME	PACK.	MATERIAL
	ALPHACAN In Alpha/ 70	300	1099867
	ALUPLAST 2000/ 3000	300	1083291
	ALUPLAST 4000/ 5000/ 6000/ 8000	300	1083288
	BRUGMANN BluEvolution	300	1083286
	DECEUNINCK 2500/ 2800	300	1083290
	EUROCELL Modus	300	1107665
	GEALAN 7000/ 8000/ S9000	300	1083289
	INOUTIC Prestige/ Arcade	300	1083290
	INOUTIC Elegante	300	1135573
	LINIAR	300	1098126
	PIMAPEN Carisma S-7000	300	1135573
	PROFINE KBE 76/ 70AD	300	1083289
1	PROFINE KÖMMERLING Eurofutur Clasic/ Elegance/ 88 Plus/ C70/ 76 MD	300	1083289
	PROFINE TROCAL 70.A5 AD/ 70.M5 MD/ 76 AD/ 76 MD	300	1083289
	REHAU S706/ S730/ System 4500/ Brilliant	300	1083287
	REHAU Geneo/ Synego	300	1083289
	ROLOPLAST 7000/ 7500/ 7500 3D	300	1098610
	ROPLASTO 7001 AD	300	1083286
	SALAMANDER 3D/ Streamline 76	300	1098610
	SCHÜCO Corona AD/ CT70 AD/ CT70 MD/ S182 MD	300	1083291
	SELECTA Advance 70	300	1083289
	VEKA Matrix/ Softline/ Softline 82/ Topline	300	1083286
	VUJIC 7000/8000	300	1098126
	WEISS WP3000/ WP4000/ WP5000	300	1083291
	WHS Halo System 10	300	1083288

System 12/20-9

TYPE	MISHANDLING DEVICE - FRAME	PACK.	MATERIAL
1	PROFINE KBE AD9	300	1083292



System independent

TYPE	SYSTEM INDEPENDENT MISHANDLING DEVICE	PACK.	MATERIAL
2	MISHANDLING DEVICE - FRAME - OHG	300	1083293
3	MISHANDLING DEVICE - FRAME - ESPAGNOLETTE OHG	300	1083295
4	MISHANDLING DEVICE - SASH	200	1093907

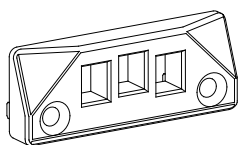
STRIKER - SECOND SASH



System 12/20-13

		
SECOND SASH STRIKER	PACK.	MATERIAL
ALPHACAN In Alpha/ 70	300	1083227
ALUPLAST 2000/ 3000/ 4000/ 5000/ 6000/ 8000	300	1083226
BRUGMANN BluEvolution	300	1083224
DECEUNINCK 2500/ 2800	300	1083228
EUROCELL Modus	300	1083227
GEALAN 7000/ 8000/ S9000	300	1083227
INOUTIC Prestige/ Arcade	300	1083228
INOUTIC Elegante	300	1131425
LINIAR	300	1097949
PESTAN S509	300	1083227
PIMAPEN Carisma S-7000	300	1131425
PROFINE KBE 76/ 70AD	300	1083227
PROFINE KÖMMERLING Eurofutur Clasic/ Elegance/ 88 Plus/ C70/ 76 MD	300	1083227
PROFINE TROCAL 70.A5 AD/ 70.M5 MD/ 76 AD/ 76 MD	300	1083227
REHAU Geneo/ Synego/ S706/ S730/ System 4500/ Brilliant	300	1083226
ROLOPLAST 7000/ 7500/ 7500 3D	300	1083226
ROPLASTO 7001 AD	300	1083226
SALAMANDER 3D/ Streamline 76	300	1083226
SCHÜCO Corona AD/ CT70 AD/ CT70 MD/ S182 MD	300	1083226
SELECTA Advance 70	300	1083227
VEKA Matrix/ Softline/ Softline 82/ Topline	300	1083224
VUJIC 7000/8000	250	1097949
WEISS WP3000/ WP4000/ WP5000	300	1083226
WHS Halo System 10	300	1083226

System 12/20-9

		
SECOND SASH STRIKER	PACK.	MATERIAL
PROFINE KBE AD9	100	1083230

NIGHT VENT STRIKER - R OR RS CAM



System 12/20-13

TYPE	STRIKER	PACK.	MATERIAL
	ALPHACAN In Alpha/ 70	100	1112468
	ALUPLAST 4000/ 5000/ 6000/ 8000	100	1112468
	BRUGMANN BluEvolution	100	1112468
	EUROCELL Modus	100	1112468
	GEALAN 7000/ 8000 /S9000	100	1112468
	INOUTIC Prestige/ Arcade	100	1095741
	INOUTIC Elegante	100	1112468
	LINIAR	100	1112468
	PROFINE KBE 76/ 70AD	100	1112468
1	PROFINE KÖMMERLING Eurofutur Clasic/ Elegance/ 88 Plus/ C70/ 76 MD	100	1112468
	PROFINE TROCAL 70.A5 AD/ 70.M5 MD/ 76 AD/ 76 MD	100	1112468
	REHAU Geneo/ Synego/ S706/ S730/ System 4500/ Brilliant	100	1112468
	ROLOPLAST 7000/ 7500/ 7500 3D	100	1112468
	ROPLASTO 7001 AD	100	1112468
	SALAMANDER 3D/ Streamline 76	100	1112468
	SCHÜCO Corona AD/ CT70 AD/ CT70 MD/ S182 MD	100	1112468
	SELECTA Advance 70	100	1112468
	VUJIC 7000/8000	100	1112468
	WEISS WP3000/ WP4000/ WP5000	100	1112468
	WHS Halo System 10	100	1112468

System 12/20-9



NIGHT VENT STRIKER - for locking cam		PACK.	MATERIAL
	PROFINE KBE AD9	100	1095293

NIGHT VENT STRIKER - R OR RS CAM



NIGHT VENT STRIKER - CORNER DRIVE NV



System 12/20-13

			
TYPE	MISHANDLING DEVICE - FRAME	PACK.	MATERIAL
	ALPHACAN In Alpha/ 70	300	1083236
	ALUPLAST 2000/ 3000	300	1083236
	ALUPLAST 4000/ 5000/ 6000/ 8000	300	1083236
	BRUGMANN BluEvolution	300	1083236
	DECEUNINCK 2500/ 2800	300	1083236
	EUROCELL Modus	300	1083236
	GEALAN 7000/ 8000/ S9000	300	1083236
	INOUTIC Prestige	300	1083238
	INOUTIC Elegante	300	1083236
	LINIAR	300	1083236
	PROFINE KBE 76/ 70AD	300	1083236
1	PROFINE KÖMMERLING Eurofutur Clasic/ Elegance/ 88 Plus/ C70/ 76 MD	300	1083236
	PROFINE TROCAL 70.A5 AD/ 70.M5 MD/ 76 AD/ 76 MD	300	1083236
	REHAU S706/ S730/ System 4500/ Brilliant	300	1083236
	REHAU Geneo/ Synego	300	1083236
	ROLOPLAST 7000/ 7500/ 7500 3D	300	1083236
	ROPLASTO 7001 AD	300	1083236
	SALAMANDER 3D/ Streamline 76	300	1083236
	SCHÜCO Corona AD/ CT70 AD/ CT70 MD/ S182 MD	300	1083236
	SELECTA Advance 70	300	1083236
	VEKA Matrix/ Softline/ Softline 82/ Topline	300	1083236
	VUJIC 7000/8000	300	1083236
	WEISS WP3000/ WP4000/ WP5000	300	1083236
	WHS Halo System 10	300	1083236

System 12/20-9

			
NIGHT VENT STRIKER - for corner drive with NV		PACK.	MATERIAL
	PROFINE KBE AD9	300	1083236

CENTER STRIKER CLOSER

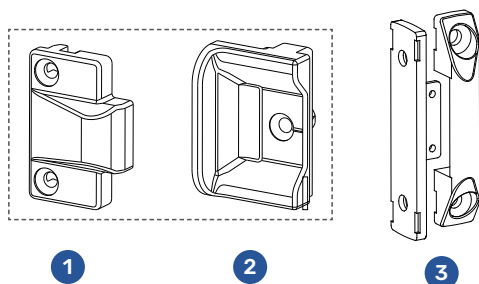

NUMBER OF STRIKERS
ACCORDING TO SASH REBATE HEIGHT

SRH	NR. OF STRIKERS
800 - 1400	1
1401 - 2000	2
2001 - 2400	3

System 12/20-13

TYPE	CONCEALED STRIKER CLOSER - FRAME	PACK.	MATERIAL
	ALPHACAN In Alpha/ 70	300	1127516
	ALUPLAST 2000/ 3000	300	1127938
	ALUPLAST 4000/ 5000/ 6000/ 8000	300	1127510
	BRUGMANN BluEvolution	300	1127937
	DECEUNINCK 2500/ 2800	300	1127517
	EUROCELL Modus	300	1127516
	GEALAN 7000/ 8000/ S9000	300	1127516
	INOUTIC Prestige/ Arcade	300	1127517
	INOUTIC Elegante	300	1131426
	PESTAN S509	300	1096401
	PIMAPEN Carisma S-7000	300	1131426
1	PROFINE KBE 76/ 70AD	300	1127516
	PROFINE KÖMMERLING Eurofutur Clasic/ Elegance/ 88 Plus/ C70/ 76 MD	300	1127516
	PROFINE TROCAL 70.A5 AD/ 70.M5 MD/ 76 AD/ 76 MD	300	1127516
	REHAU Geneo/ Synego/ S706/ S730/ System 4500/ Brilliant	300	1127512
	ROLOPLAST 7000/ 7500/ 7500 3D	300	1098611
	ROPLASTO 7001 AD	300	1127512
	SALAMANDER 3D/ Streamline 76	300	1098611
	SCHÜCO Corona AD/ CT70 AD/ CT70 MD/ S182 MD	300	1127938
	SELECTA Advance 70	300	1127516
	VEKA Matrix/ Softline/ Softline 82/ Topline	300	1127937
	WEISS WP3000/ WP4000/ WP5000	300	1127938
	WHS Halo System 10	300	1127510

System 12/20-9

	CONCEALED STRIKER CLOSER - FRAME	PACK.	MATERIAL
1	PROFINE KBE AD9	300	1127518

System independent

	SYSTEM INDEPENDENT CENTER STRIKER CLOSER	PACK.	MATERIAL
2	CONCEALED STRIKER CLOSER - SASH PART	200	1127509
3	CENTER STRIKER - SASH AND FRAME PART	200	1083304

BULLET CATCH

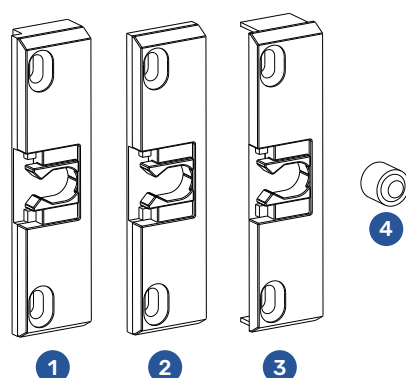

System 12/20-13

TYPE	BULLET CATCH - FRAME	PACK.	MATERIAL
	ALPHACAN In Alpha/ 70	100	1099868
	ALUPLAST 2000/ 3000	100	1083311
	ALUPLAST 4000/ 5000/ 6000/ 8000	100	1083308
	BRUGMANN BluEvolution	100	1083309
	DECEUNINCK 2500/ 2800	100	1083312
	EUROCELL Modus	100	1083309
	GEALAN 7000/ 8000/ S9000	100	1083309
	INOUTIC Prestige/ Arcade	100	1083312
	INOUTIC Elegante	100	1135574
	PIMAPEN Carisma S-7000	100	1135574
1	PROFINE KBE 76/ 70AD	100	1083309
	PROFINE KÖMMERLING Eurofutur Clasic/ Elegance/ 88 Plus/ C70/ 76 MD	100	1083309
	PROFINE TROCAL 70.A5 AD/ 70.M5 MD/ 76 AD/ 76 MD	100	1083309
	REHAU Geneo/ Synego/ S706/ S730/ System 4500/ Brilliant	100	1083307
	ROLOPLAST 7000/ 7500/ 7500 3D	100	1098612
	SALAMANDER 3D/ Streamline 76	100	1098612
	SCHÜCO Corona AD/ CT70 AD/ CT70 MD/ S182 MD	100	1083311
	SELECTA Advance 70	100	1083309
	VEKA Matrix/ Softline/ Softline 82/ Topline	100	1083306
	WEISS WP3000/ WP4000/ WP5000	100	1083311
	WHS Halo System 10	100	1083308

System 12/20-9

TYPE	BULLET CATCH - FRAME	PACK.	MATERIAL
1	PROFINE KBE AD9	100	1093915

System independent

TYPE	SYSTEM INDEPENDENT BULLET CATCH	PACK.	MATERIAL
2	BULLET CATCH - FRAME - ESPAGNOLETTE OHG	100	1093200
3	BULLET CATCH - FRAME - OHG	100	1107887
4	BULLET CATCH CAM - SASH PART	2000	1083305







Installation instructions

Profile treatment, hardware mounting, hardware maintenance
Detailed information

Window-handle drilling

GEAR-CASE SPROCKET AND LUGS' DRILL HOLE

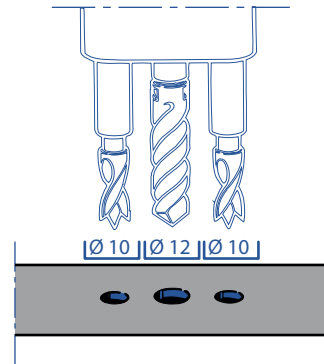
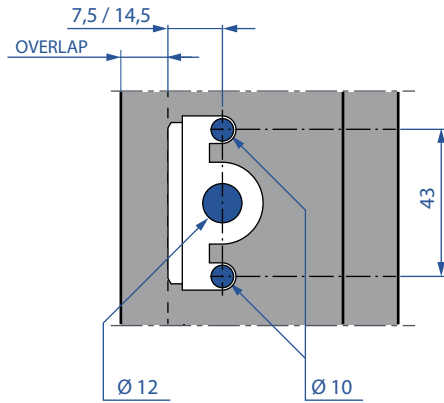

Gear-case routing

ESPAGNOLETTE GEAR-CASING

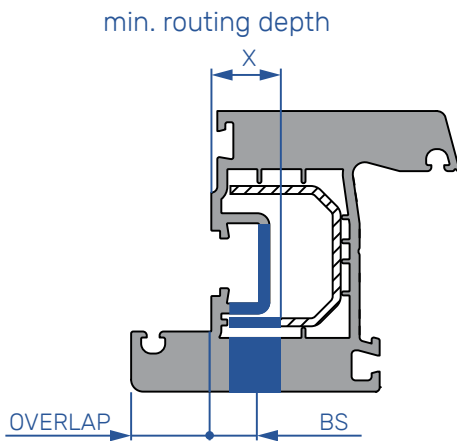

BS	X
7,5	20
14,5	27

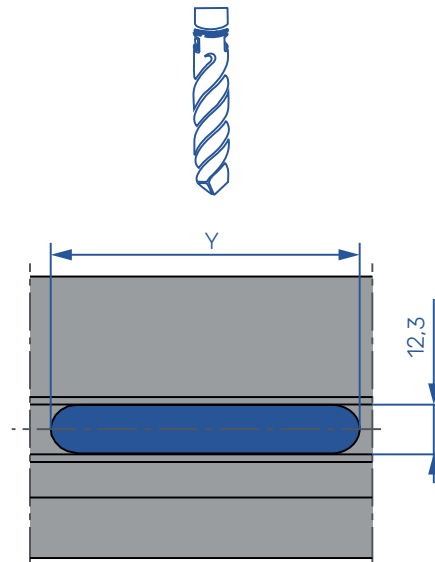

BS	Y
7,5	34
14,5	64

Lock-case drilling

ESPAGNOLETTE LOCK-CASING

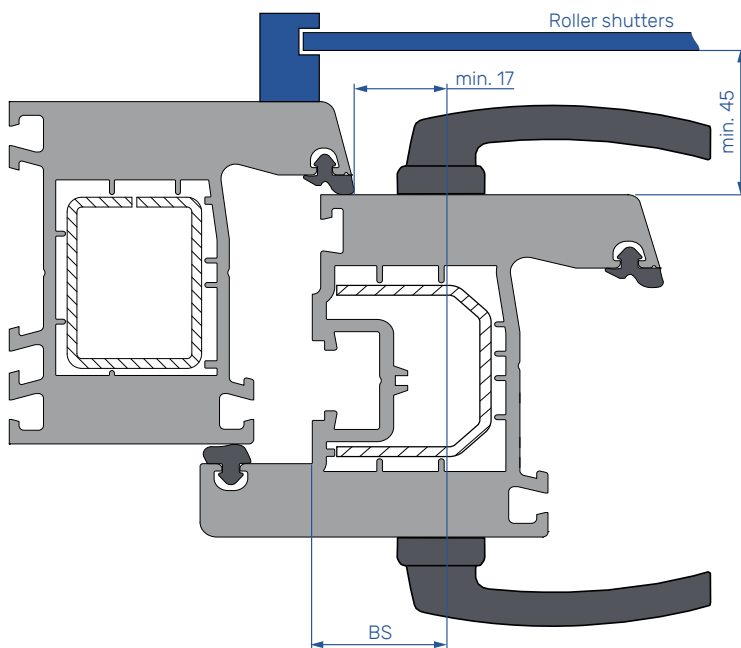
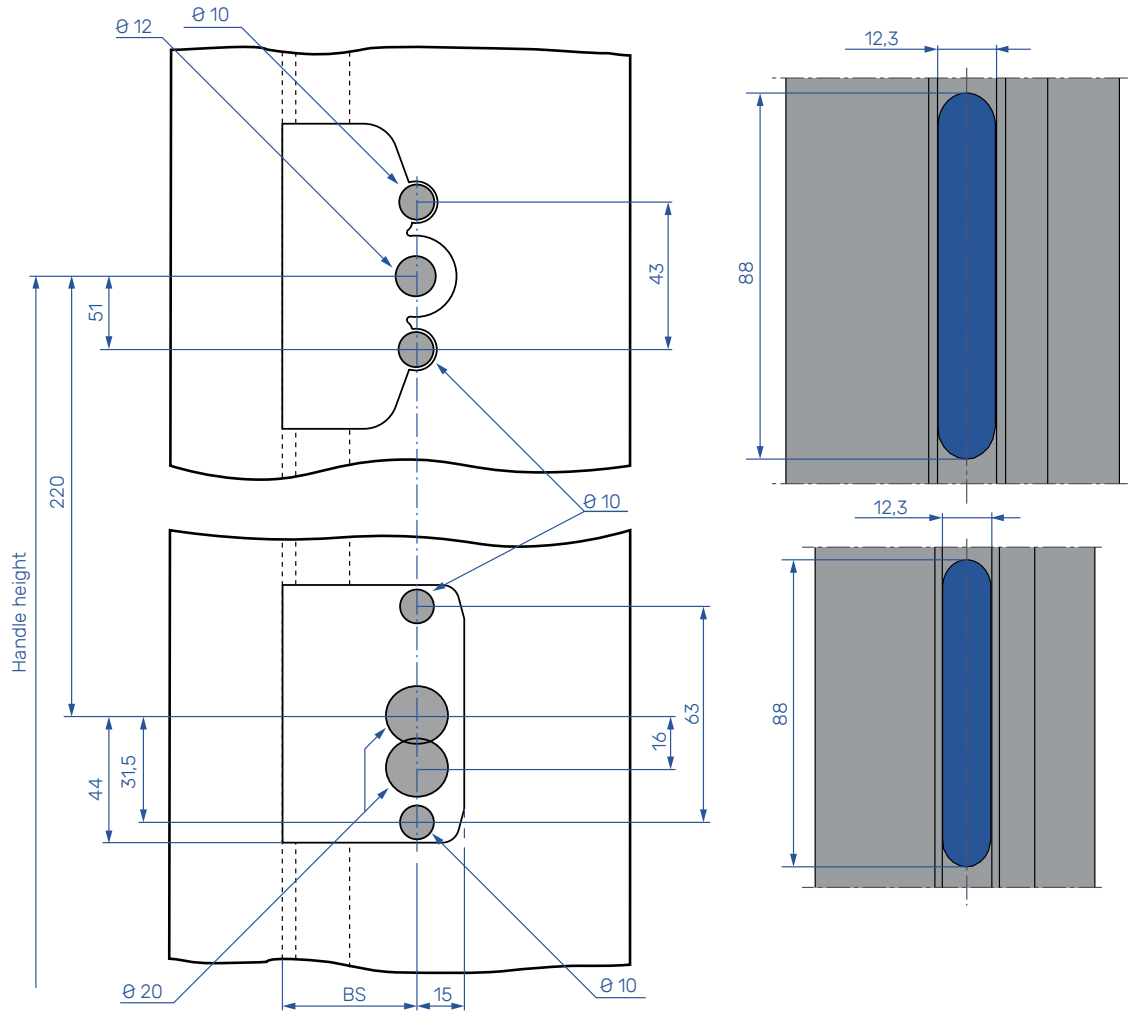

Corner hinge K3

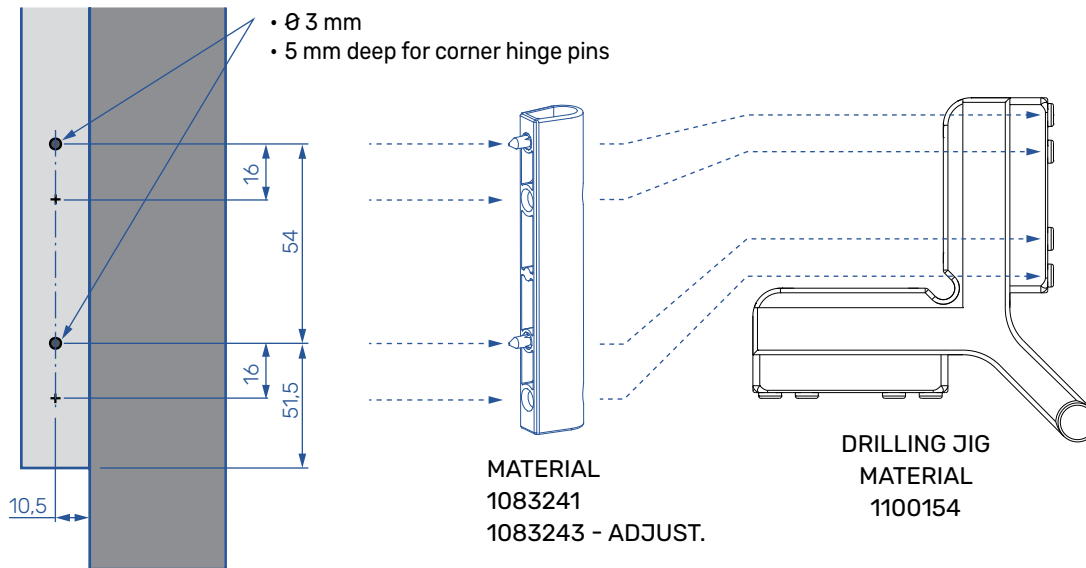

Recommendation:

- Pre-drill 2 shallow pilot holes for better screw guidance.

*WHEN USING AN 18 OR 22 mm HARDWARE OVERLAP, READJUST THE DRILLING JIG.

Corner hinge K6

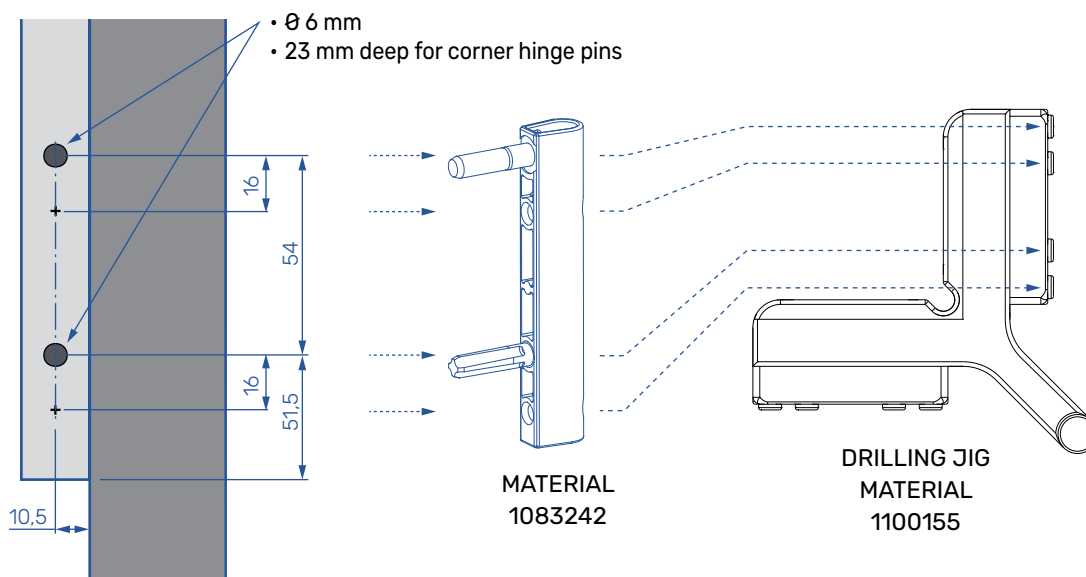

Recommendation:

- Pre-drill 2 shallow pilot holes for better screw guidance.

*WHEN USING AN 18 OR 22 mm HARDWARE OVERLAP, READJUST THE DRILLING JIG,

*SUPPORTING-PINS AND SCREWS MUST PENETRATE AT LEAST TWO PROFILE WALLS.

Sash stay bearing K3

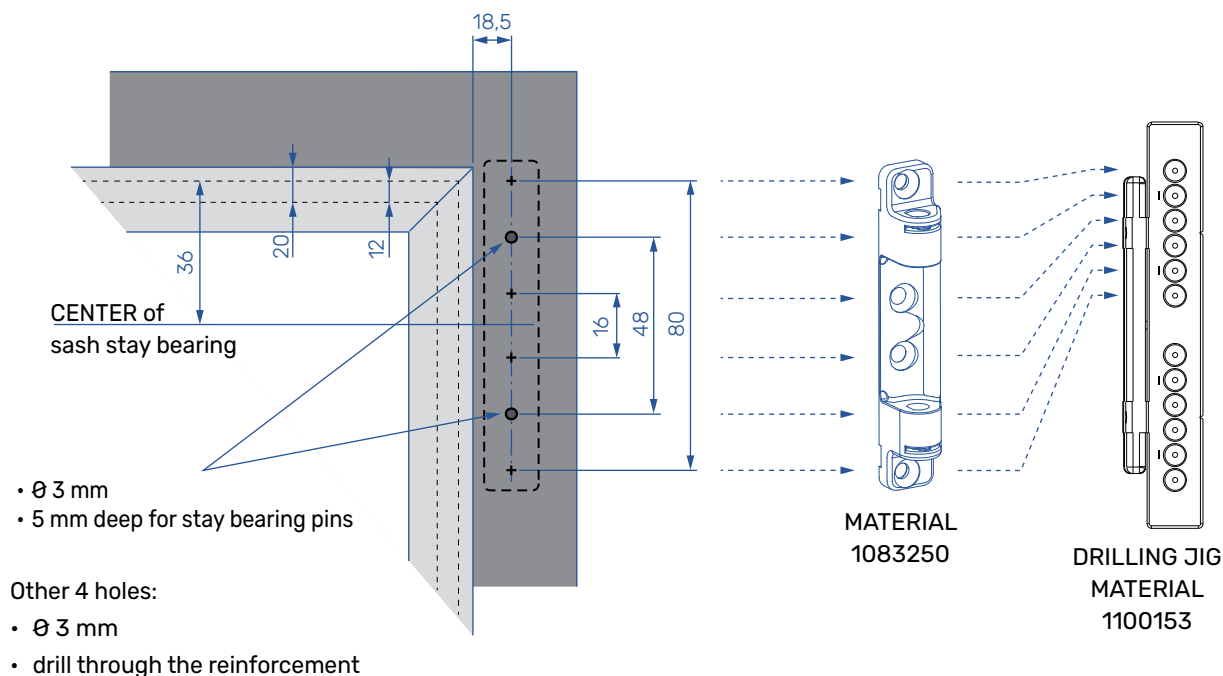

*WHEN USING AN 18 OR 22 mm HARDWARE OVERLAP, READJUST THE DRILLING JIG.

Sash stay bearing K6

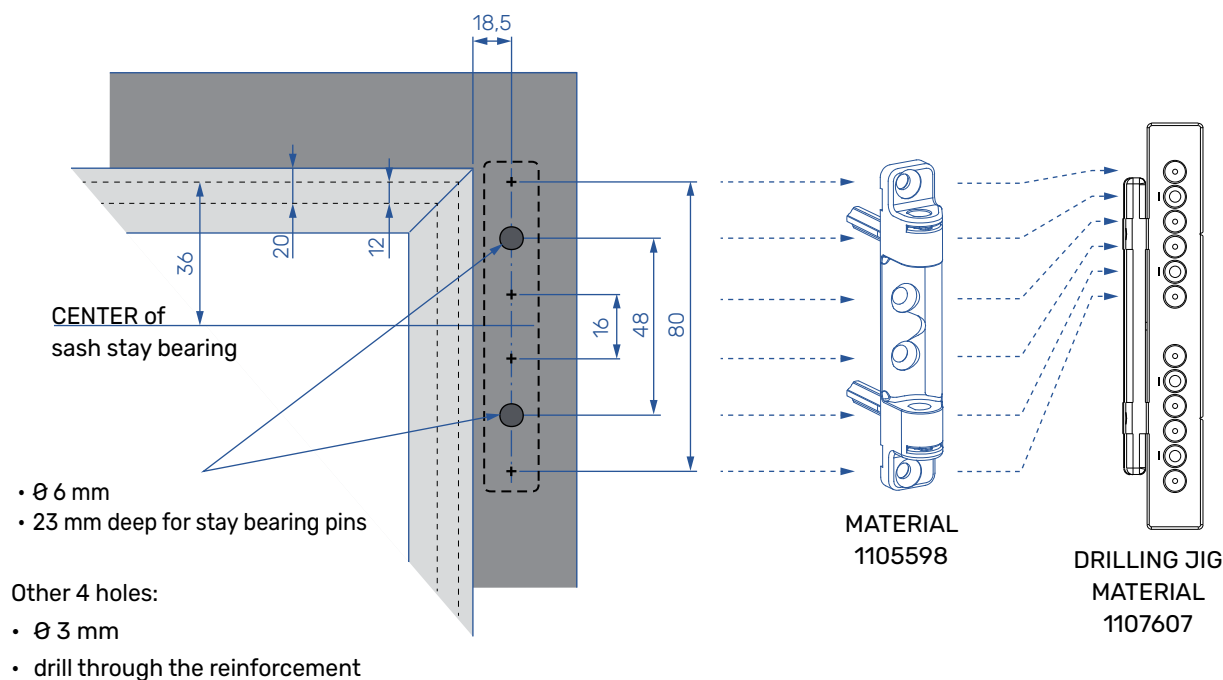

*WHEN USING AN 18 OR 22 mm HARDWARE OVERLAP, READJUST THE DRILLING JIG,

*SUPPORTING-PINS AND SCREWS MUST PENETRATE AT LEAST TWO PROFILE WALLS.

Corner pivot rest K3

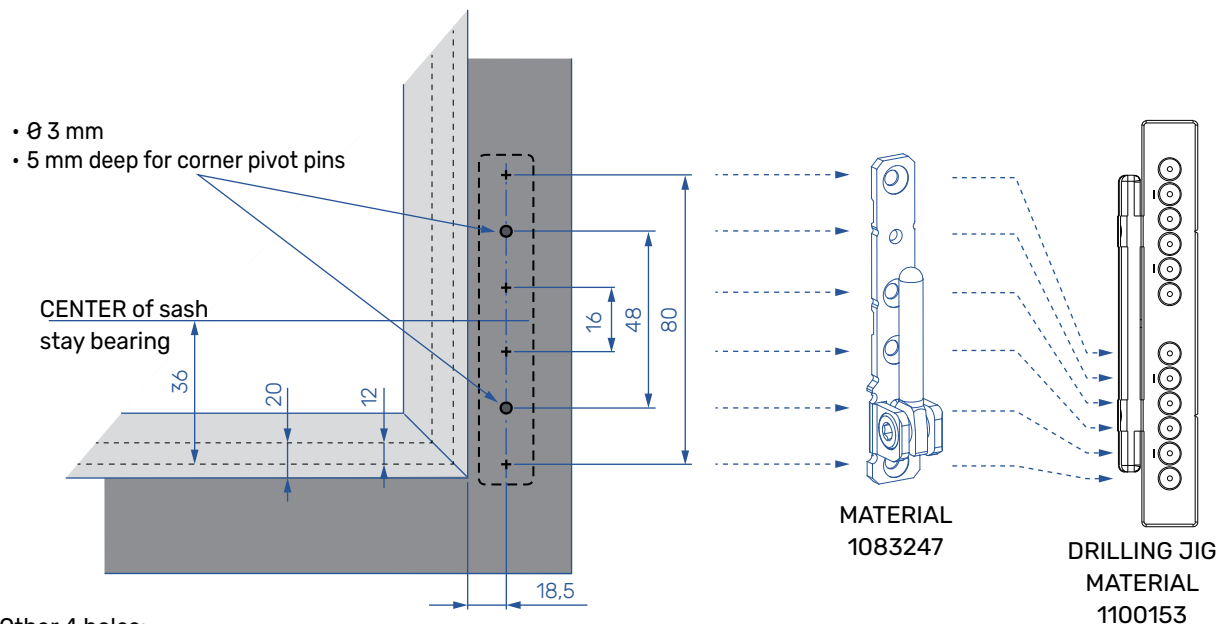

Other 4 holes:

- Ø 3 mm
- drill through the reinforcement

*WHEN USING AN 18 OR 22 mm HARDWARE OVERLAP, READJUST THE DRILLING JIG.

Corner pivot rest K6

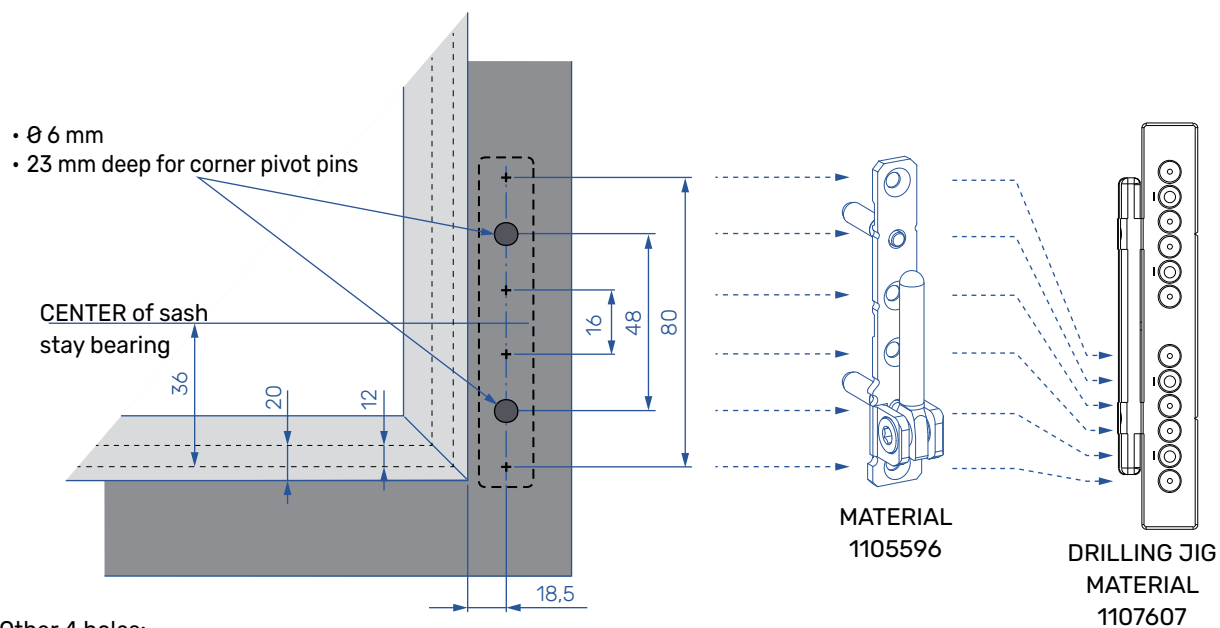

Other 4 holes:

- Ø 3 mm
- drill through the reinforcement

*WHEN USING AN 18 OR 22 mm HARDWARE OVERLAP, READJUST THE DRILLING JIG,
*SUPPORTING-PINS AND SCREWS MUST PENETRATE AT LEAST TWO PROFILE WALLS.

Pitched window - upper hinge

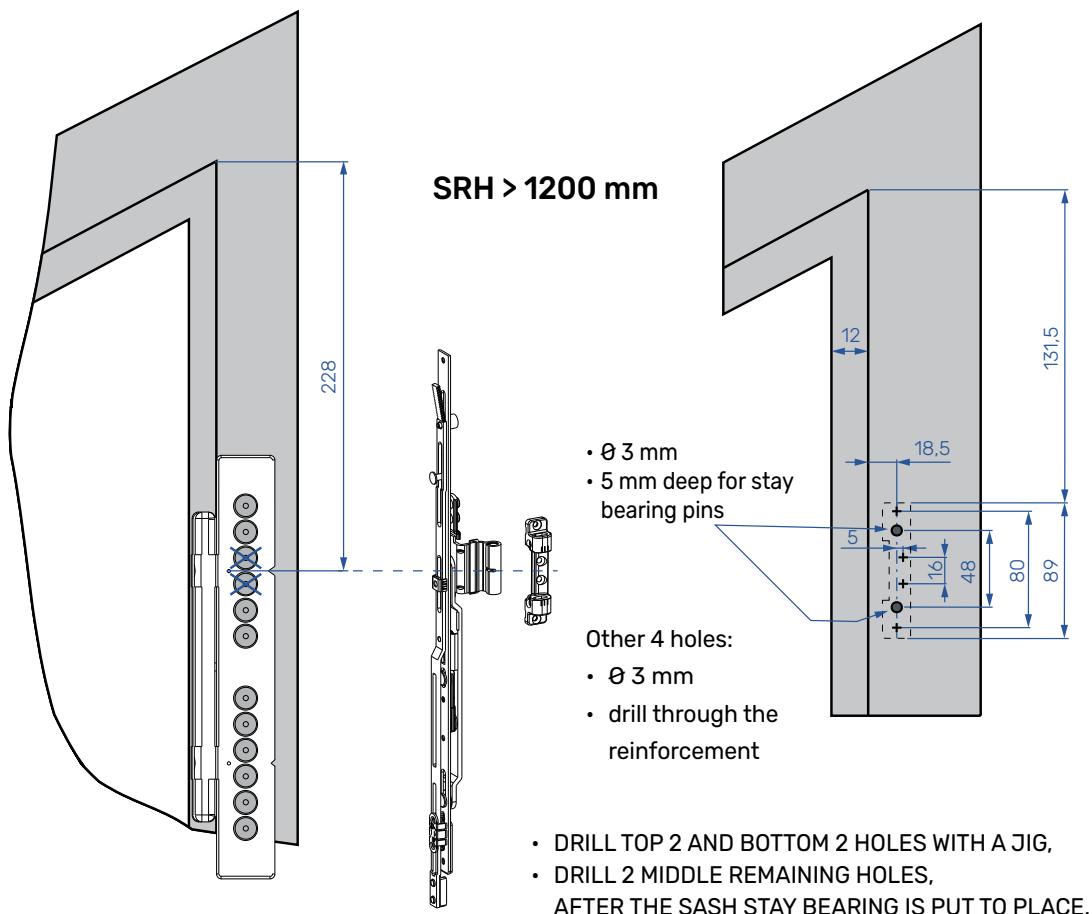
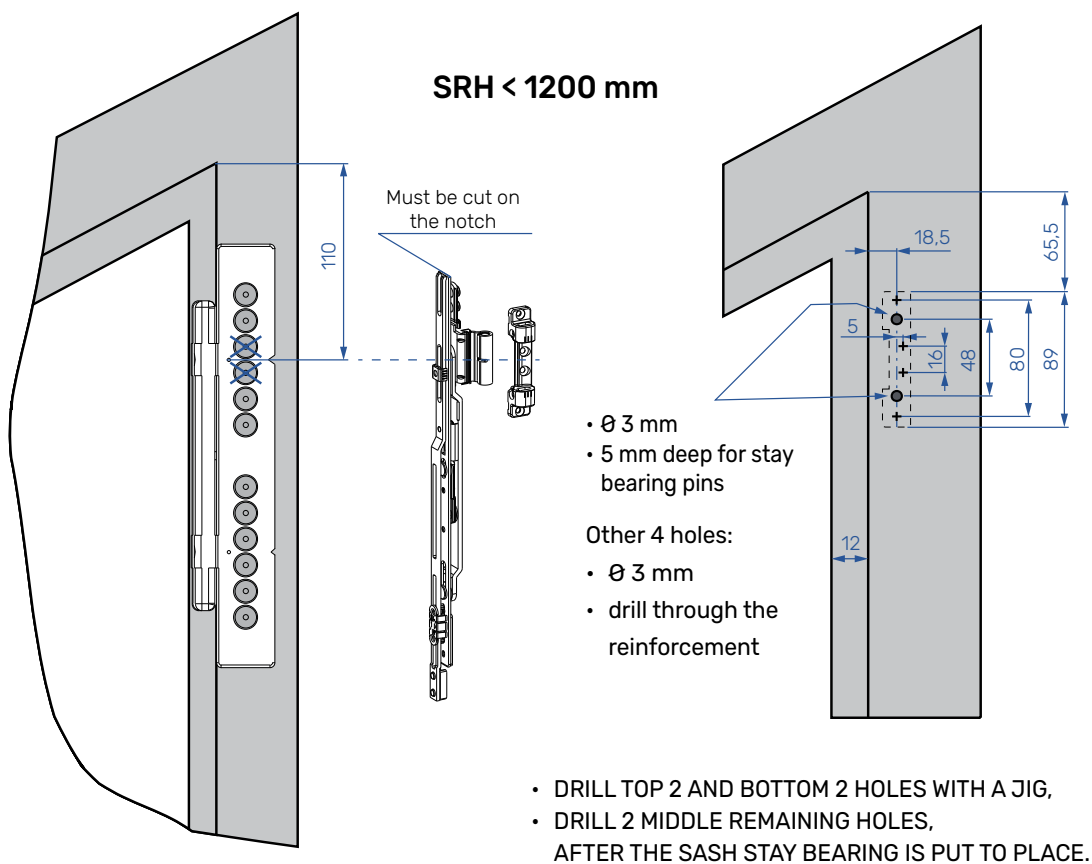

Arched window - upper hinge

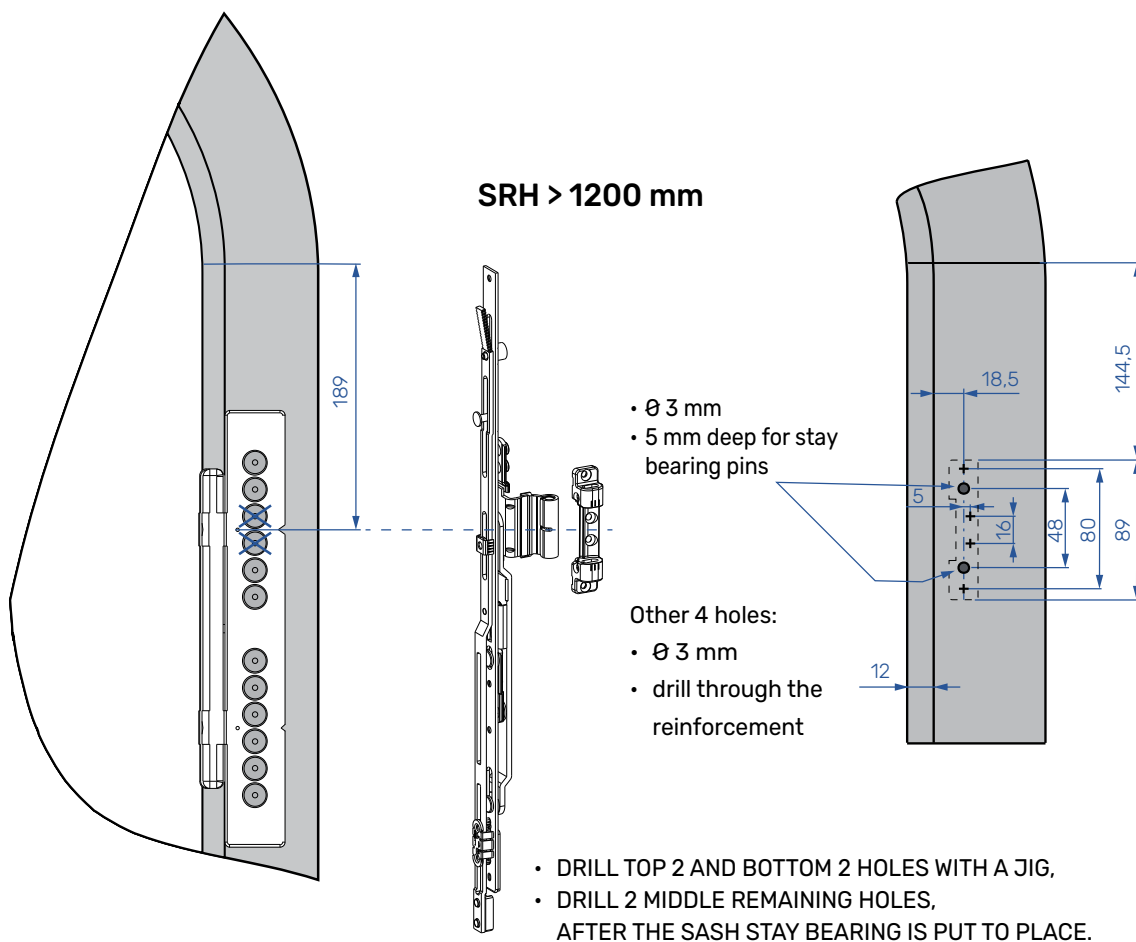
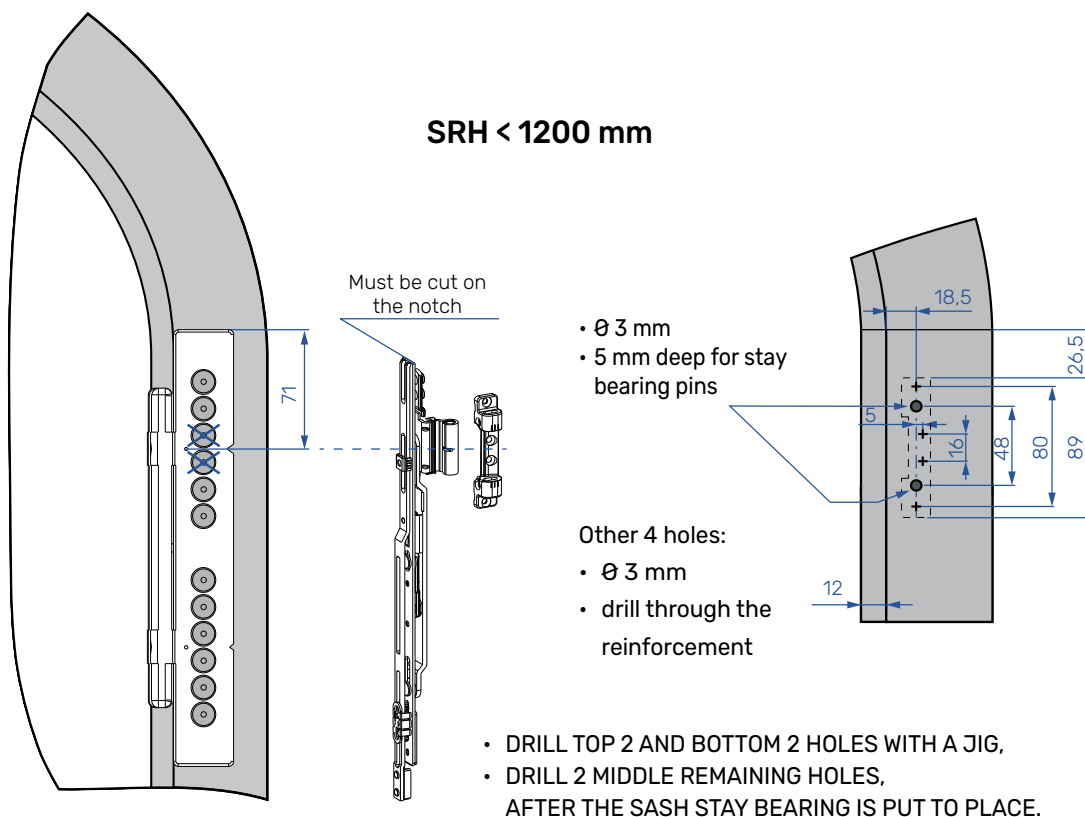

Arched larger window - upper hinge

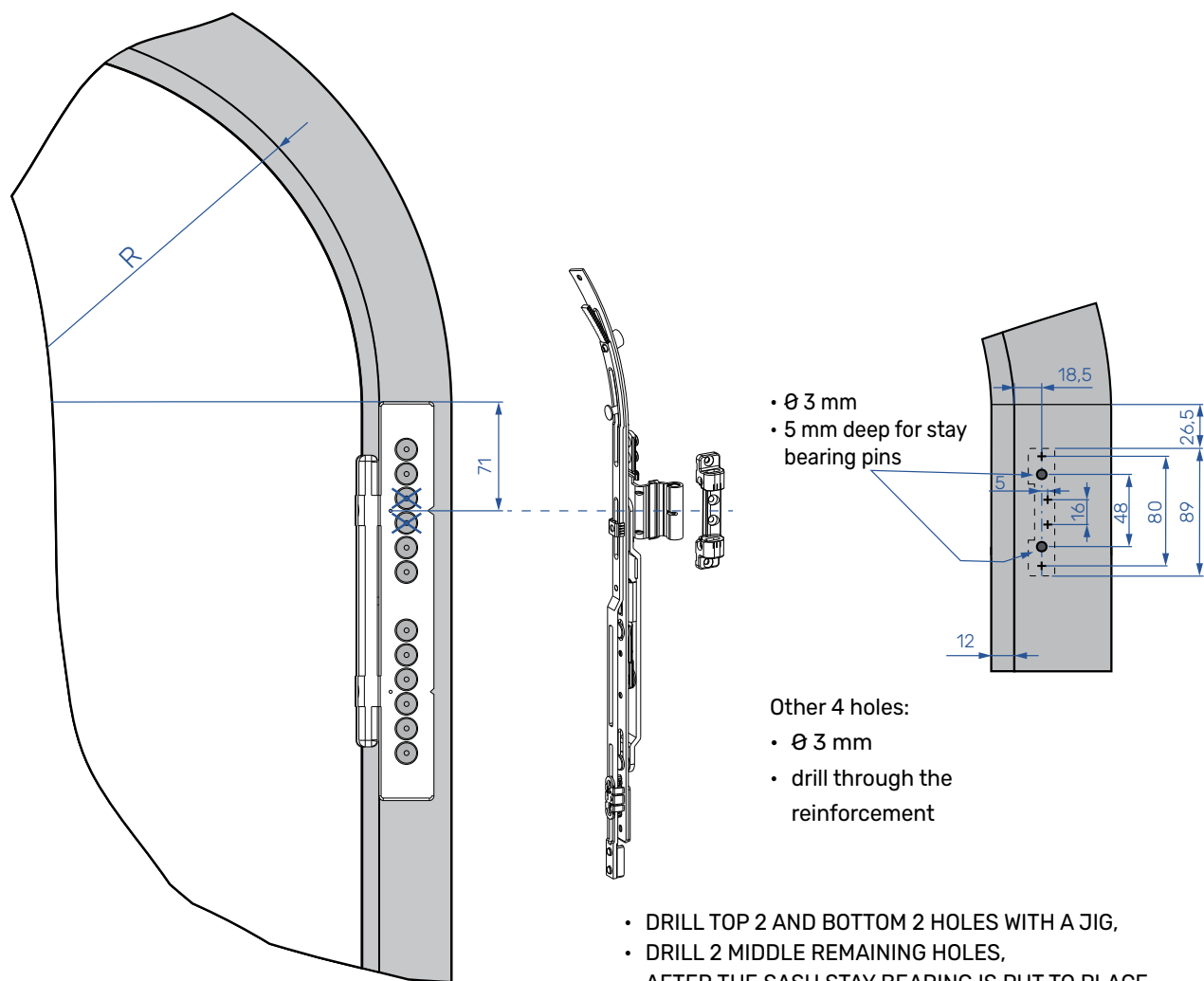

INSTALLATION INSTRUCTIONS

Pitched / arched window - sash lifter

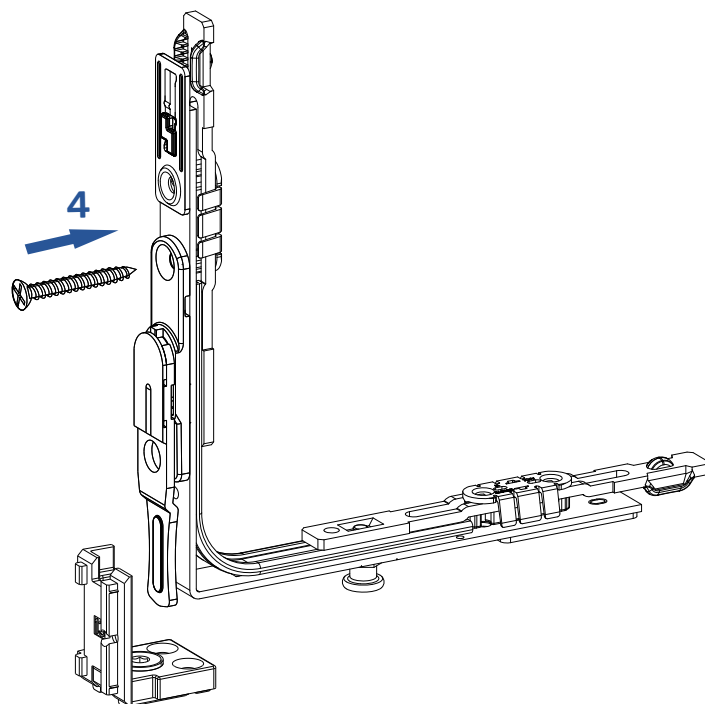
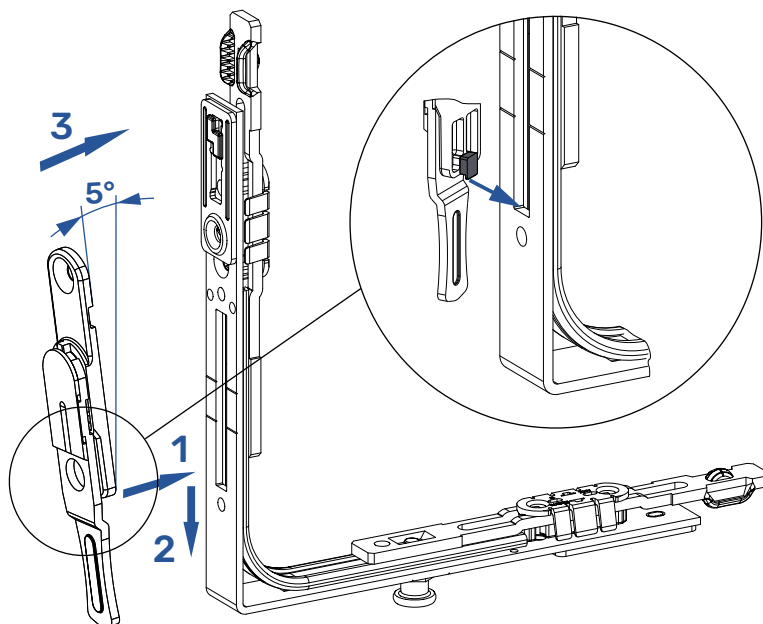

INSTALLATION INSTRUCTIONS

Sash stay guide and center lock assembly

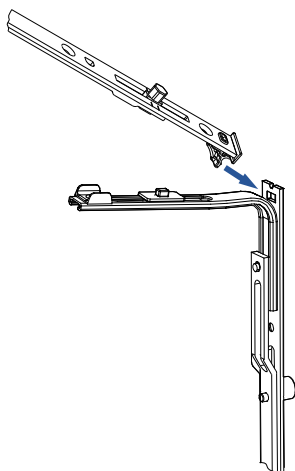

1.) Insert the connecting bracket into the hole of a center lock

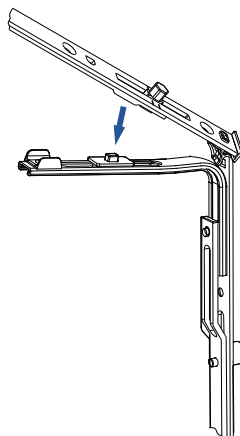

2.) Clamp the hole of a driving rod onto the stay guide connector

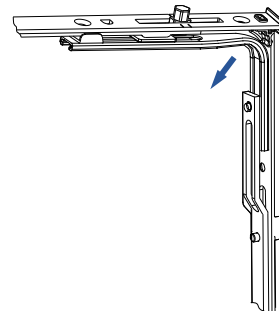

3.) Insert the assembly into a sash groove

Tilt lock bolt and center lock assembly

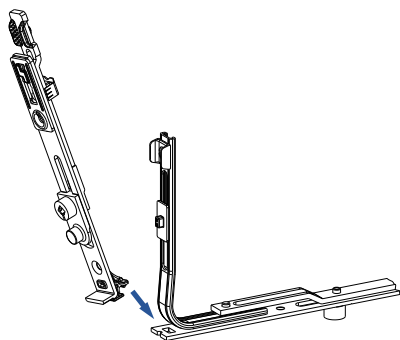

1.) Insert the connecting bracket into the hole of a center lock

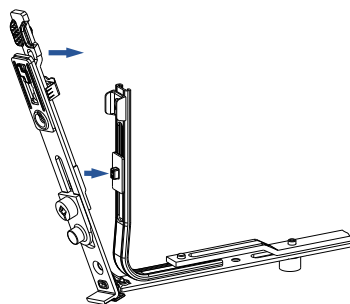

2.) Clamp the hole of a driving rod onto the tilt lock bolt connector

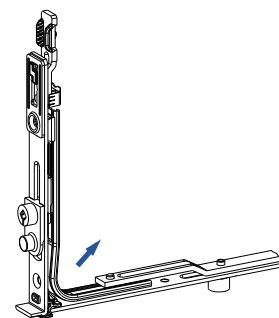

3.) Insert the assembly into a sash groove

T&T system with T&T espagnolette

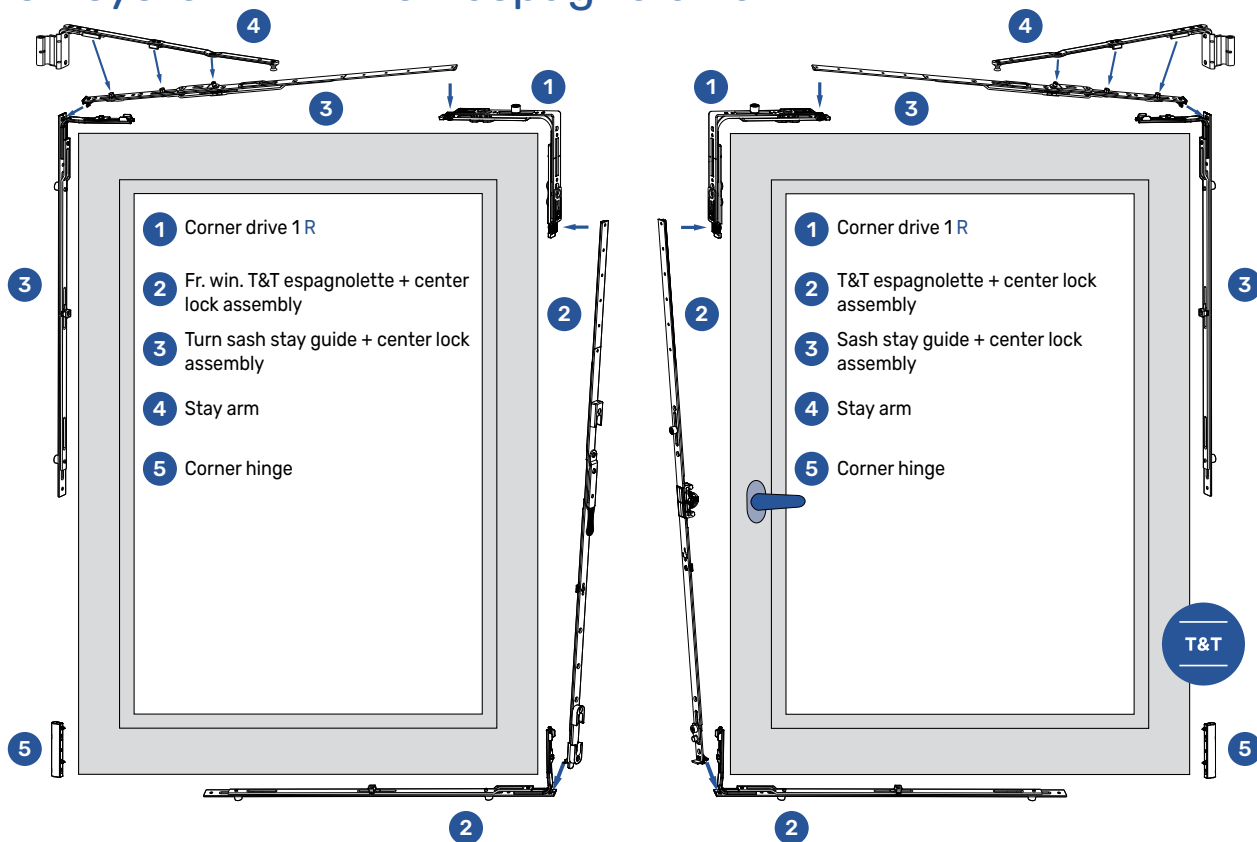

T&Ti system with T&T M espagnolette

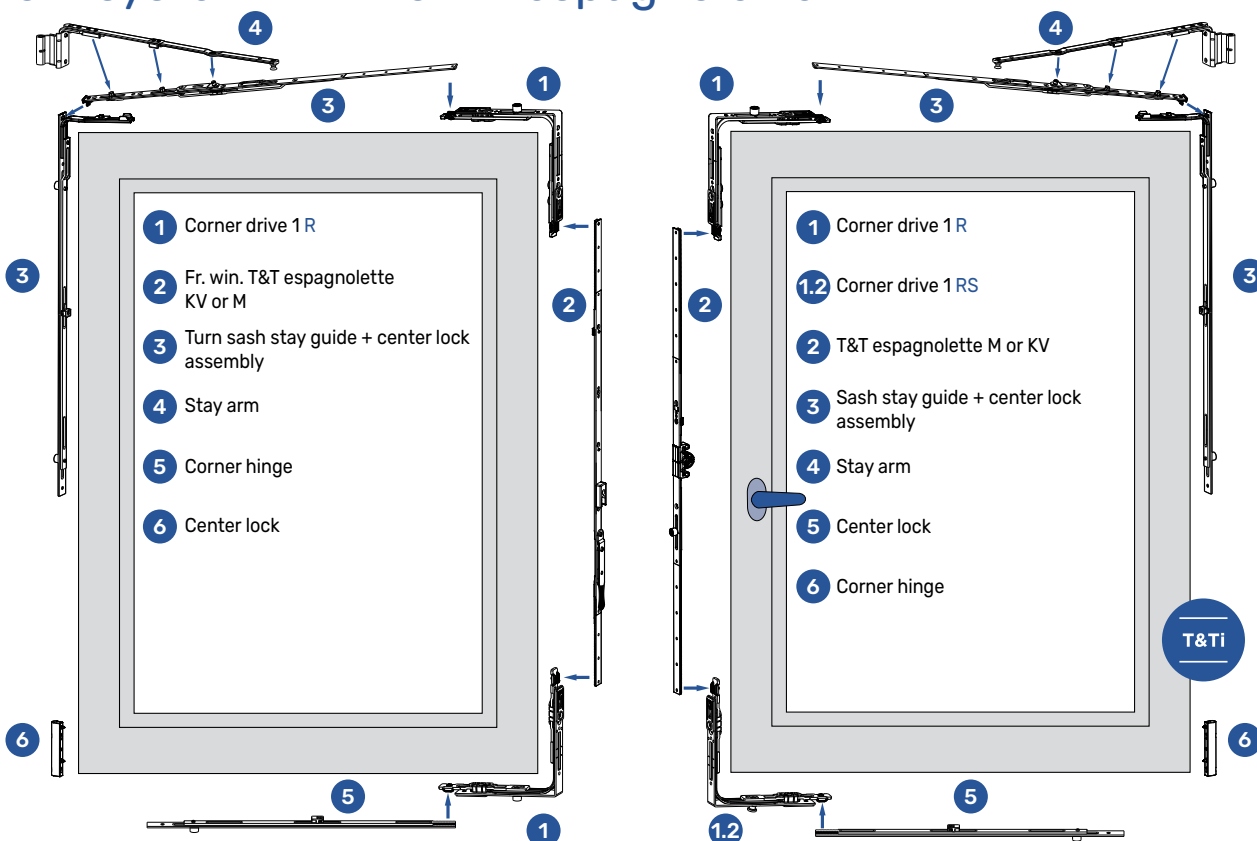

INSTALLATION INSTRUCTIONS

Slider

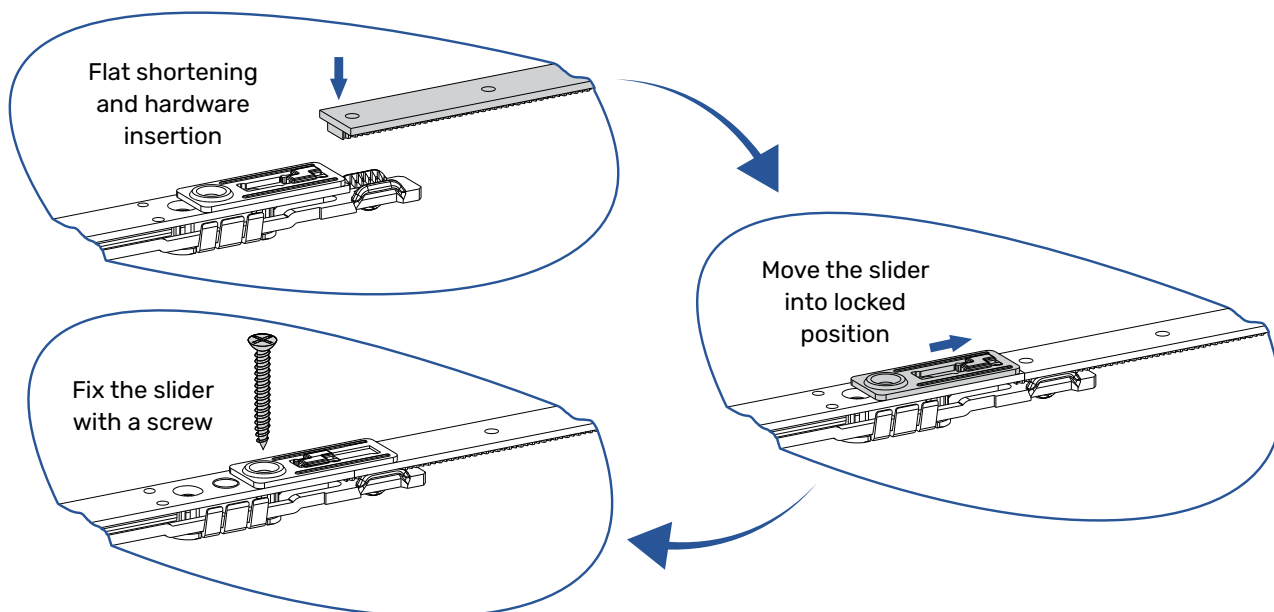

Anti slam device - tilt reduction

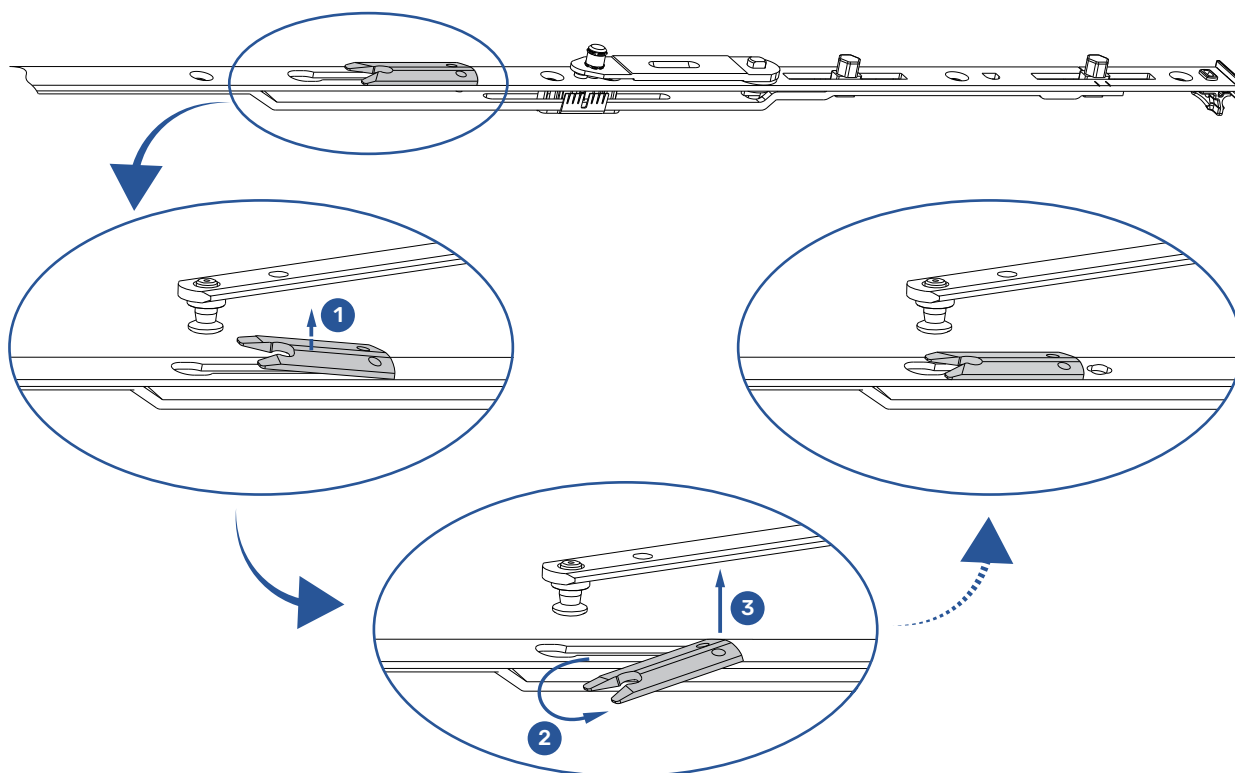

*PICTURES REPRESENT THE ADJUSTMENT OF THE ANTI-SLAM DEVICE (TILT REDUCEMENT)

*MOVE THE ANTI-SLAM DEVICE ON WINDOWS SRH < 500 mm, TO REDUCE TILT

CONCEALED HINGE SIDE INSTALLATION INSTRUCTIONS

Tilt & turn / Turn only

Stay arm and corner pivot - frame mounting

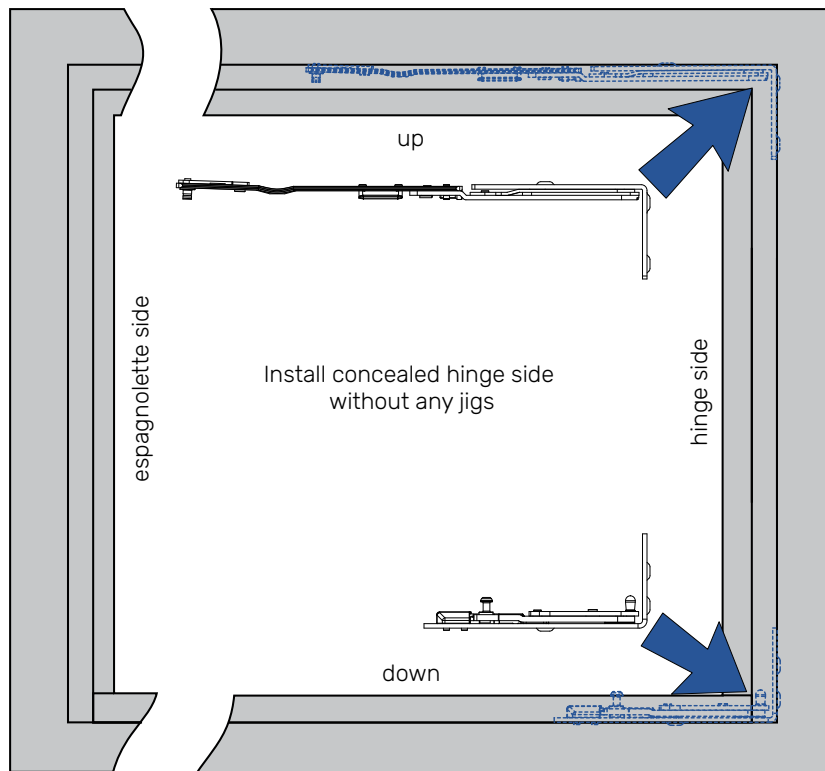

Corner pivot and corner hinge - frame mounting

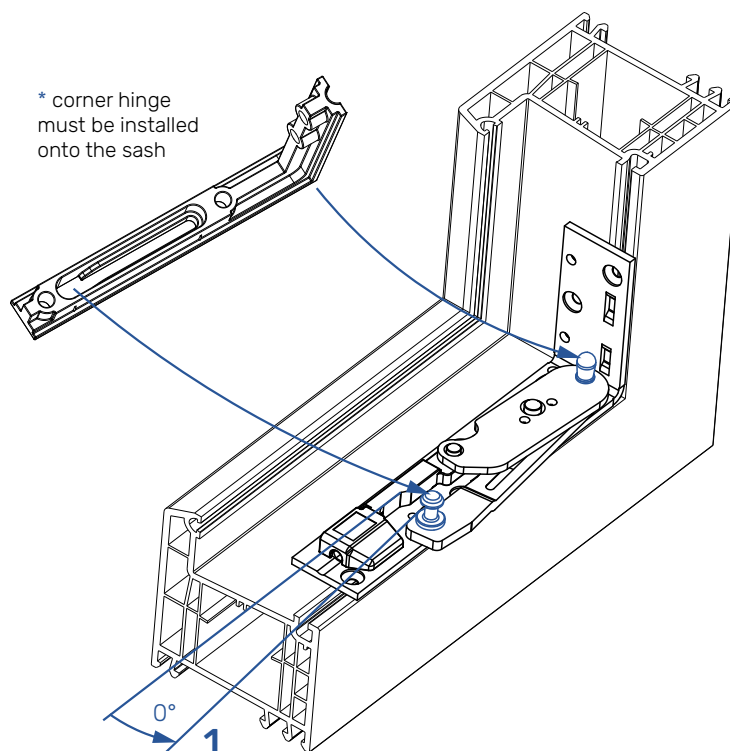

The sash (with corner hinge) is lowered vertically onto the corner pivot.
The corner pivot is in closed position (0°).

CONCEALED HINGE SIDE INSTALLATION INSTRUCTIONS

Tilt & turn / Turn only

Stay arm and sash stay guide

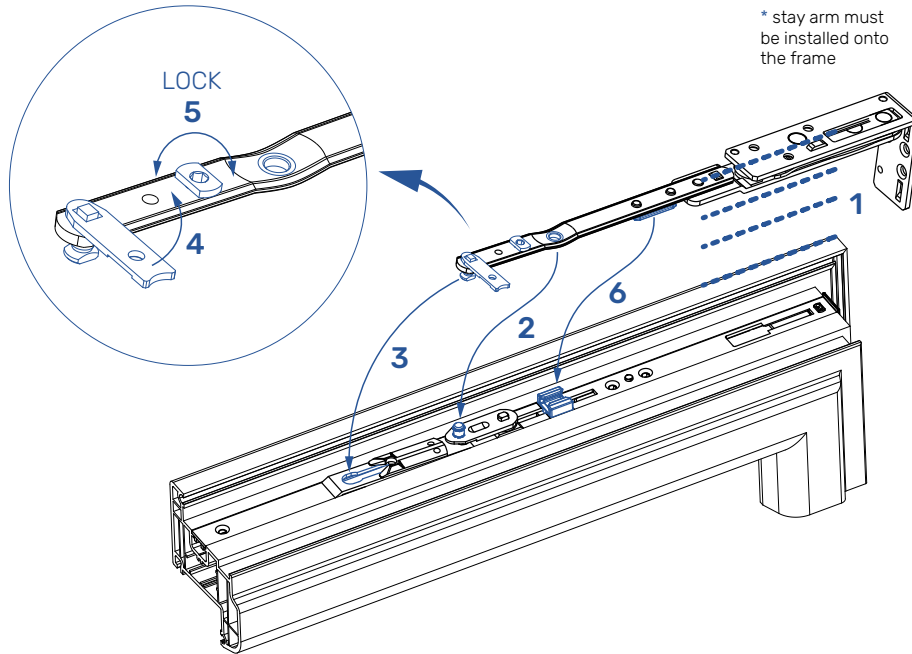

TURN & TILT - TURN FIRST

TURN THE HANDLE INTO VERTICAL (TILT) POSITION

1. align the sash parallel with stay arm,
2. connect the pin with stay arm,
- 3-5. engage the locking mechanism,
6. turn the handle back to horizontal (turn) position, to engage the connectors on stay arm and sash stay guide.

TILT & TURN - TILT FIRST

TURN THE HANDLE INTO HORIZONTAL (TILT) POSITION

1. align the sash parallel with stay arm,
2. connect the pin with stay arm,
- 3-5. engage the locking mechanism,
6. turn the handle to vertical (turn) position, to engage the connectors on stay arm and sash stay guide.

* FOR REBATE STAY ARM AND REBATE STAY ARM GUIDE FOLLOW STEPS 1.-5.

Turn limiter and turn limiter holder

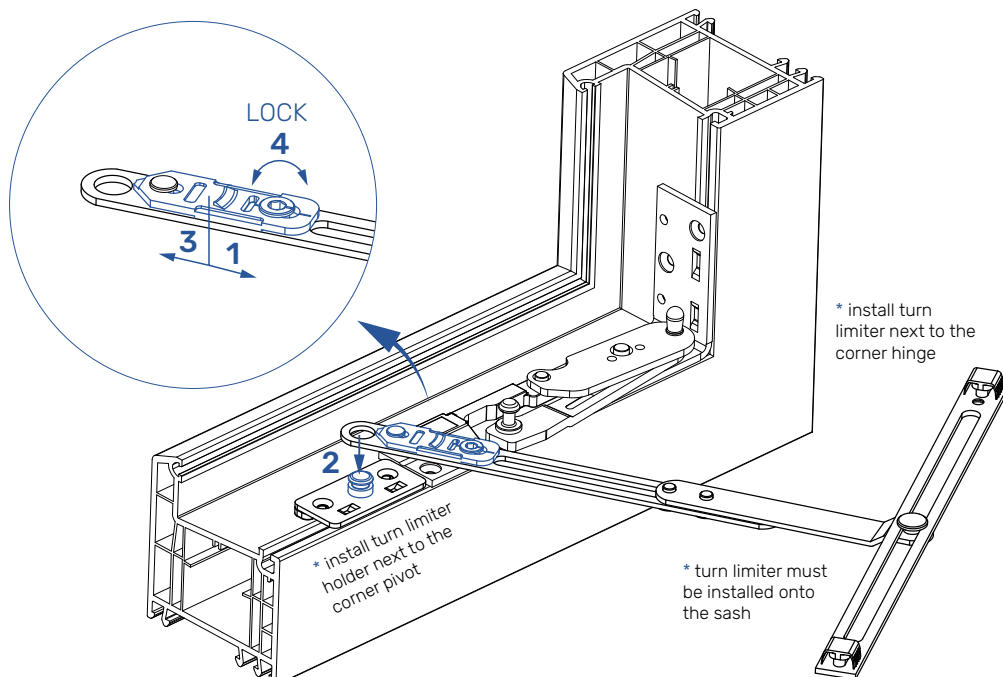

CONCEALED HINGE SIDE INSTALLATION INSTRUCTIONS

Tilt only

Rebate stay arm - frame mounting

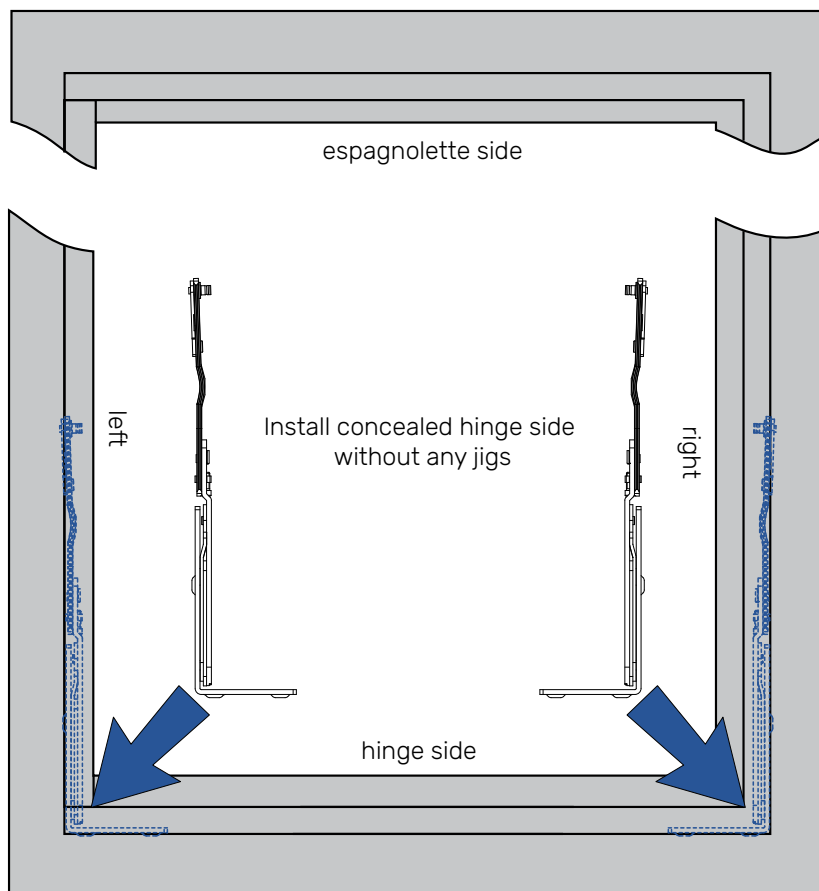

CONCEALED HINGE SIDE INSTALLATION INSTRUCTIONS

Tilt only

Rebate stay arm and rebate stay arm guide

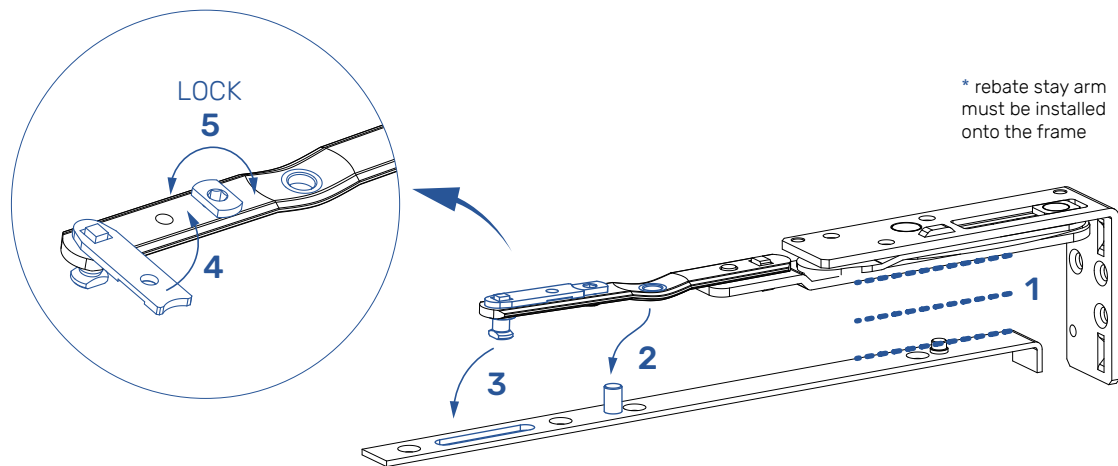

TURN ONLY

1. align the sash parallel with stay arm,
2. connect the pin with rebate stay arm,
- 3-5. engage the locking mechanism.

Rebate stay arm orientation

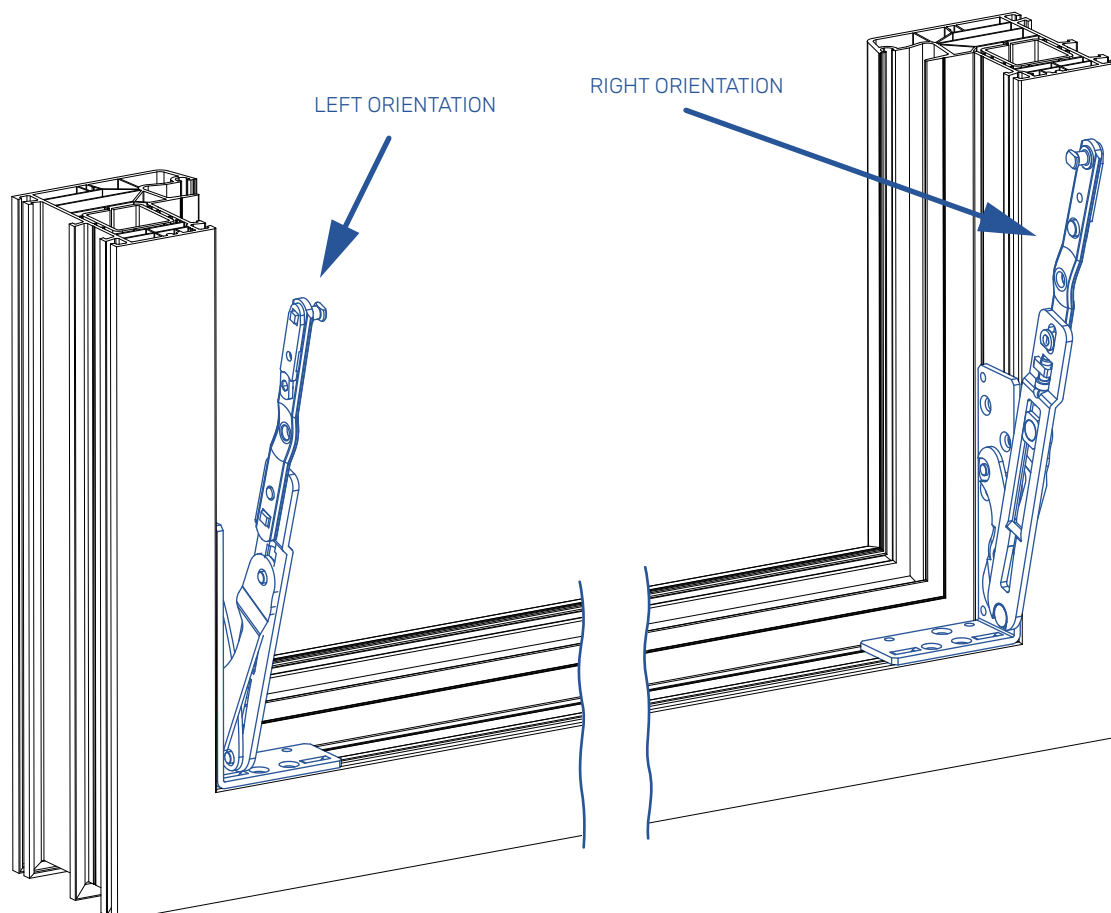

STRIKER JIGS INSTALLATION INSTRUCTIONS

Types

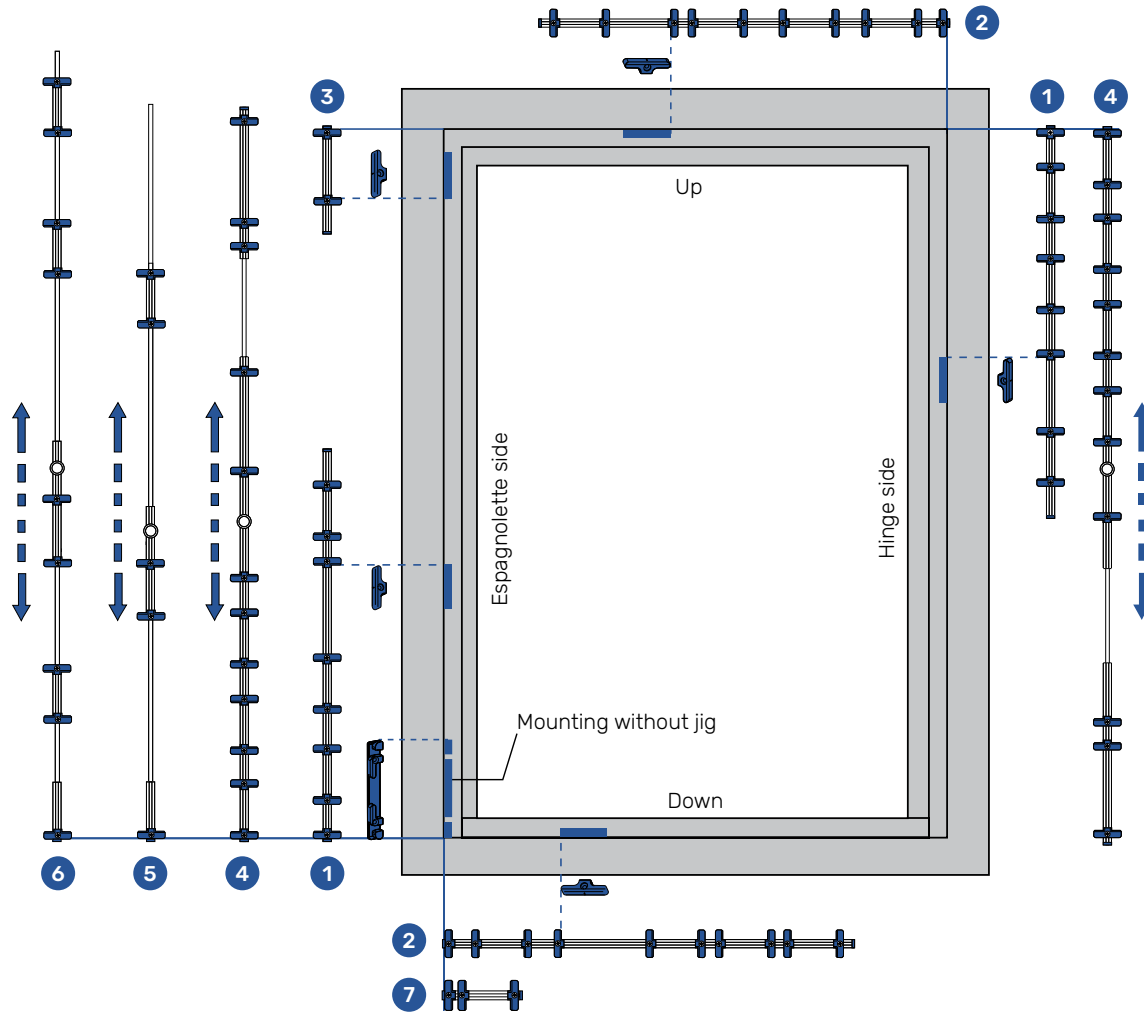

TYPE	DESCRIPTION	NOTE	MATERIAL
1	Constant handle height espag. / hinge side center lock	SRH < 1600	1103566
1a	TYPE 1 - with additional cam - telescopic jig	SRH < 1600	1103567
2	Center lock and sash stay guide up / center lock down	SRW < 1400	1103568
3	Corner drive	SRW < 1400	1103569
4	Constant handle height espag. - telescopic jig (door)	SRH > 1601	1103570
4a	TYPE 4 - with additional cam	SRH > 1601	1103571
5	Centered handle height espag. - telescopic jig (window)	SRH < 1600	1103572
5a	TYPE 5 - with additional cam	SRH < 1600	1103573
6	Centered handle height espag. - telescopic jig (door)	SRH > 1601	1103574
6a	TYPE 6 - with additional cam	SRH > 1601	1103575
7	T&Ti striker	SRW < 1400	1108014

STRIKER JIGS INSTALLATION INSTRUCTIONS

Instructions for use

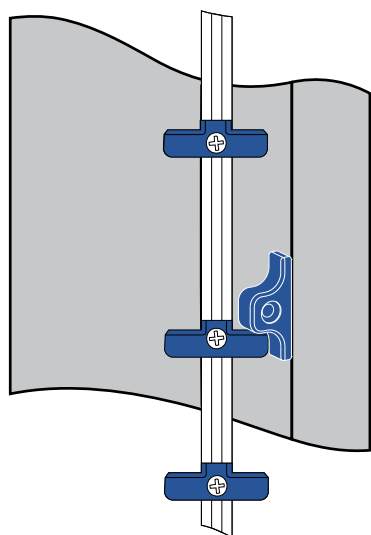

MSD scheme

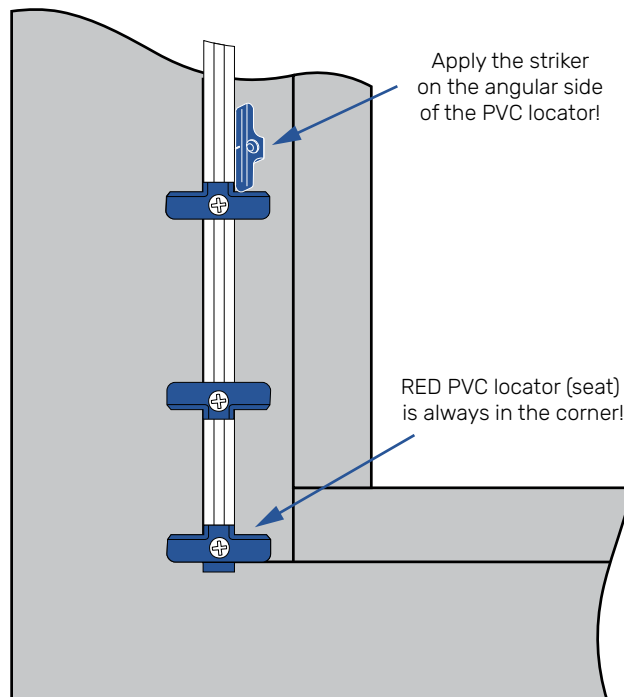

CAM scheme



COLOR of PVC LOCATOR	DESCRIPTION	NOTES
RED	Seat - NO locking cam	No striker
YELLOW	Corner drive locking cam	Located next to the seat
YELLOW	Espagnolette locking cam	/
GREEN	Mishandling device - frame part	Montage shown on MSD scheme
BLUE	Sash stay guide locking cam	/
BROWN	Center lock locking cam	/

Face-fit hinge side

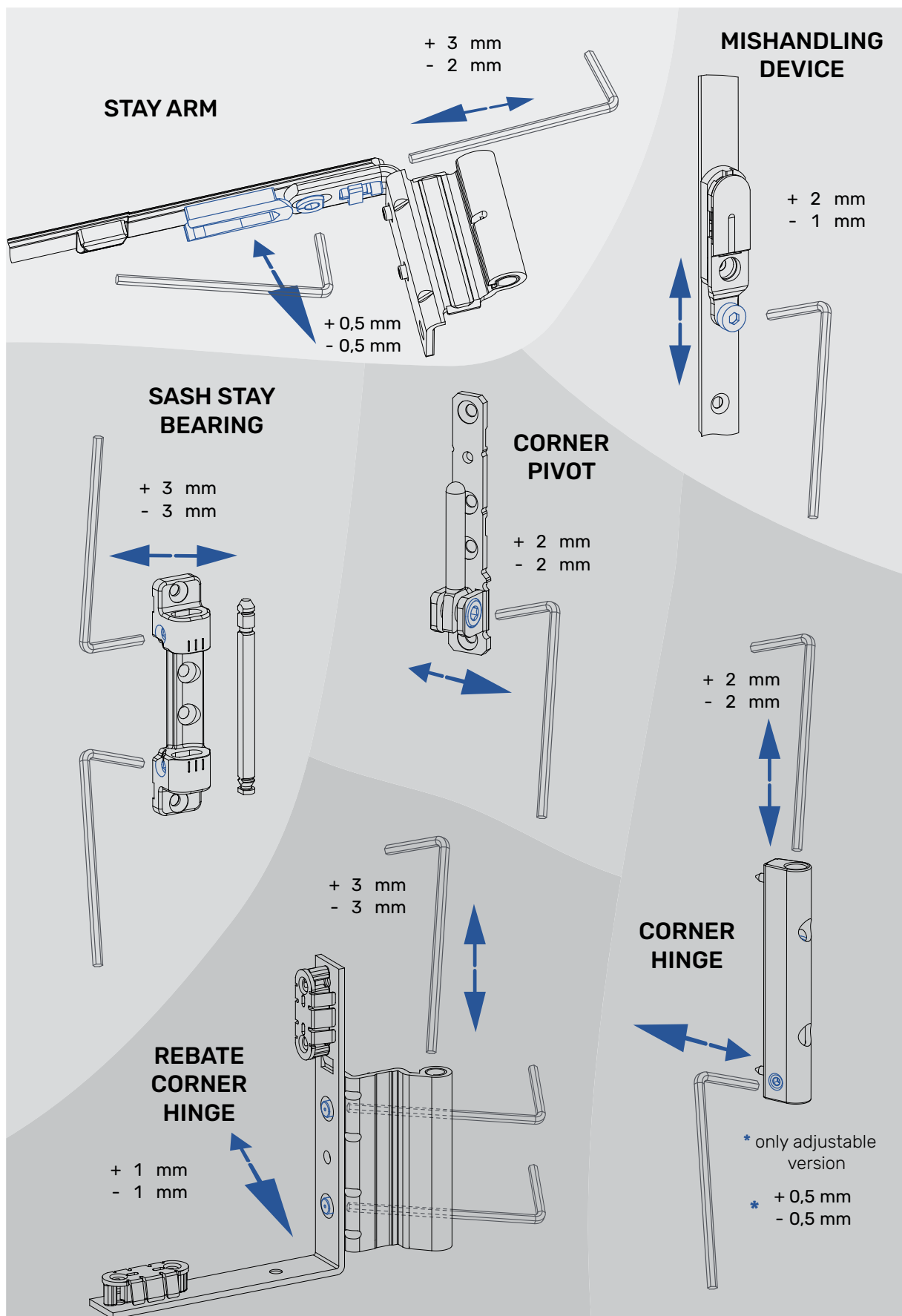

Concealed hinge side

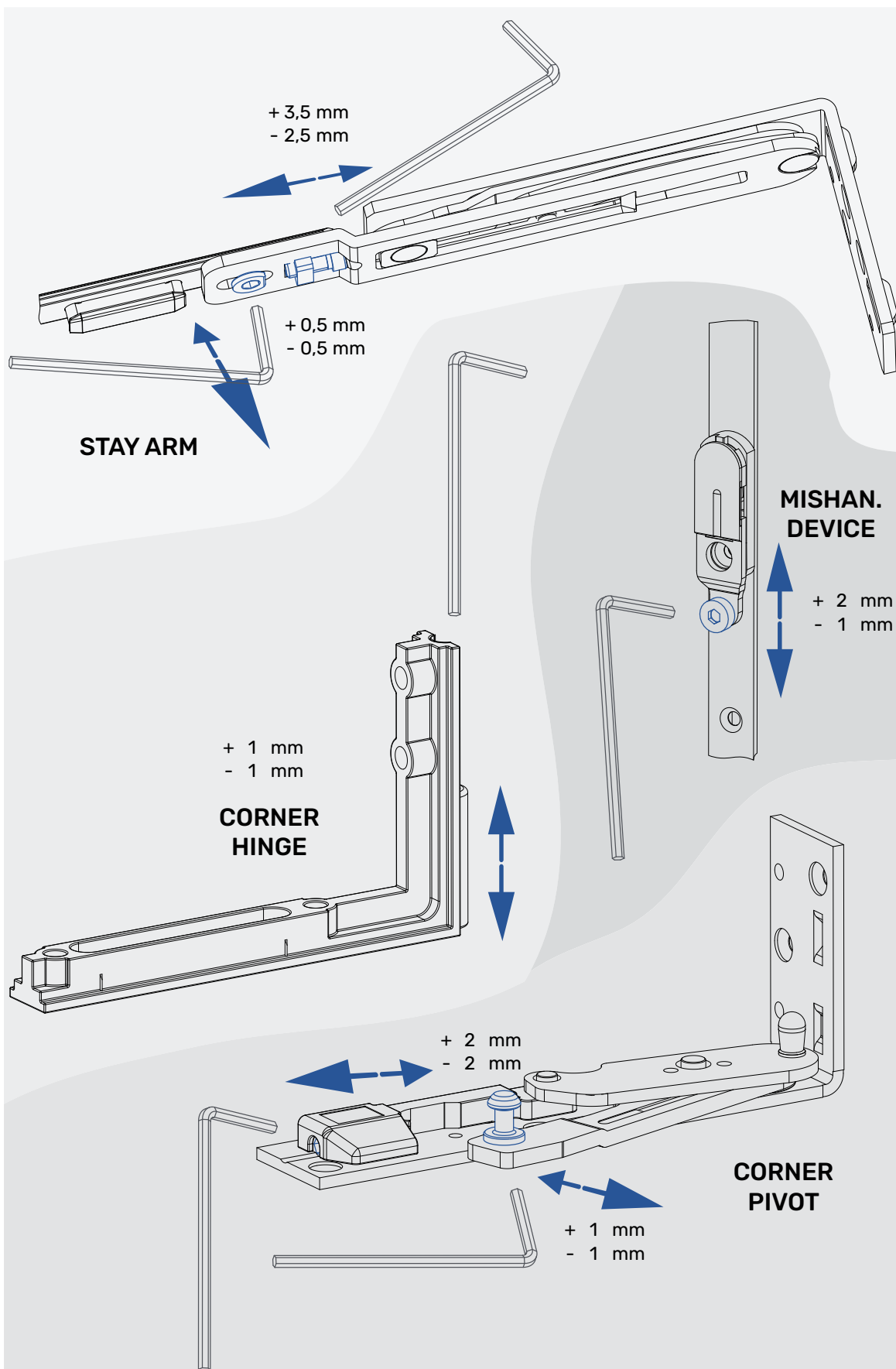

LOCKING CAM ADJUSTMENT INSTRUCTIONS

ROLLING CAM / R CAM

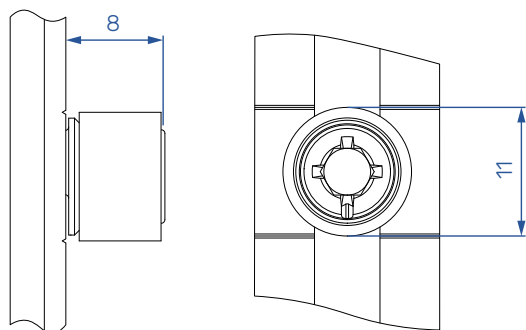
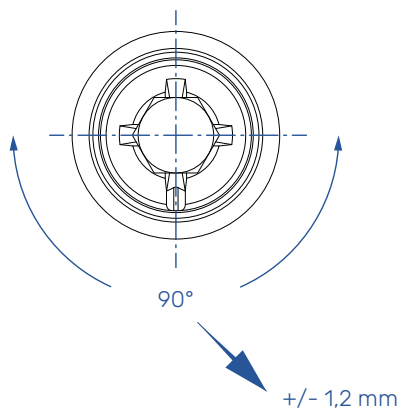

ROLLING SECURITY CAM / RS CAM

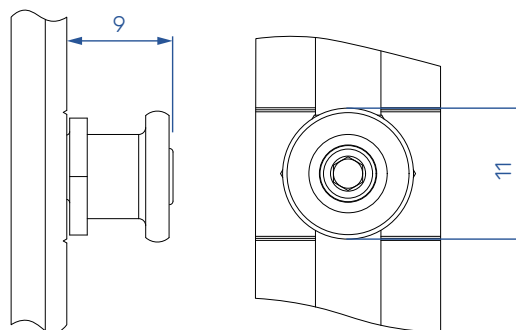
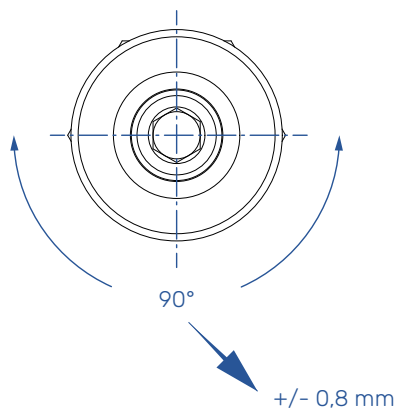

R CAM ADJUSTMENT TOOL

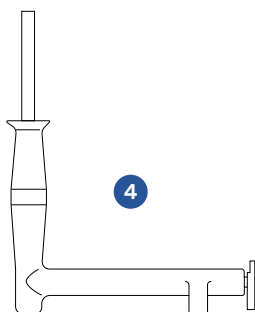
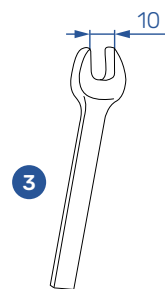
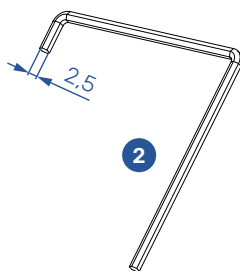
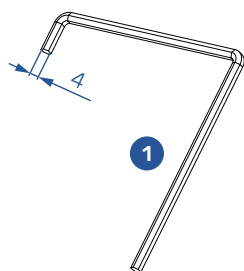

TYPE	DESCRIPTION	SIZE	MATERIAL
1	HEX KEY	4 mm	1095750
2	HEX KEY	2,5 mm	/
3	SPANNER	10 mm	/
4*	MOUNTING HANDLE	/	1134960

* FOR SASH STAY BEARING PIN MOUNTING

MAINTENANCE RECOMMENDATIONS

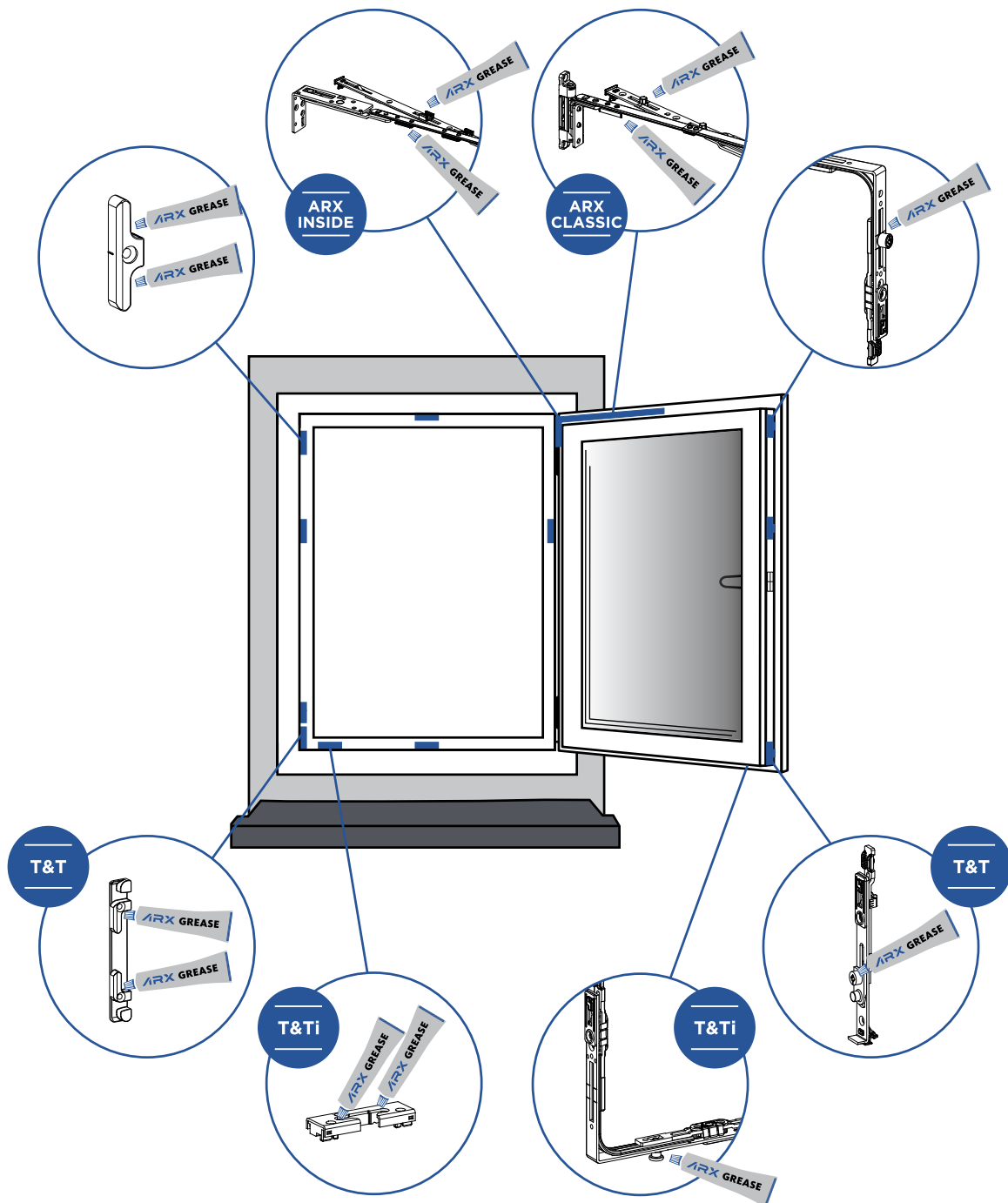

Regular greasing and oiling of operation-relevant components in the sash and frame is recommended at least once a year. In case of frequent use as in schools, hotels the oiling is recommended once in six months.

Acid free and non-resinous grease and/or oil from a specialized dealer must be used.



DESCRIPTION	MATERIAL
ARX - HIGH QUALITY HARDWARE GREASE	1055144



DESCRIPTION
MATERIAL

Operation of window

TURN & TILT - TURN FIRST

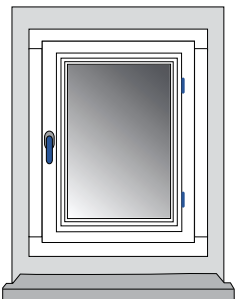

CLOSED POSITION

TILT & TURN - TILT FIRST

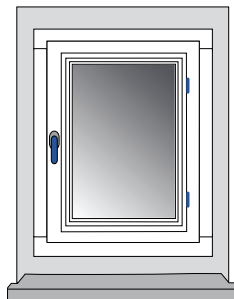

CLOSED POSITION

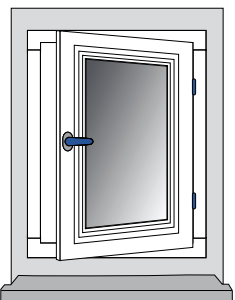

OPENED POSITION - TURN

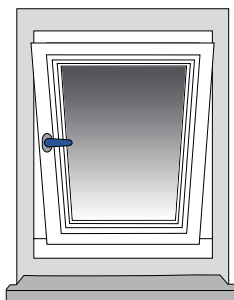

OPENED POSITION - TILT

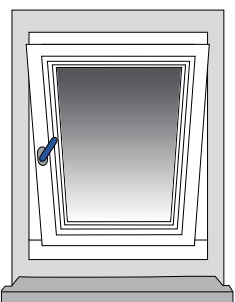

NIGHT VENT POSITION

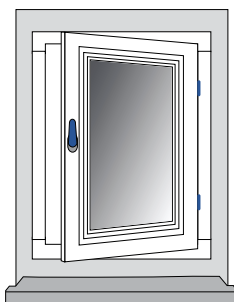

OPENED POSITION - TURN

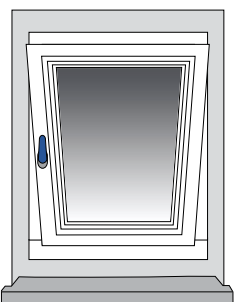

OPENED POSITION - TILT

Warning!

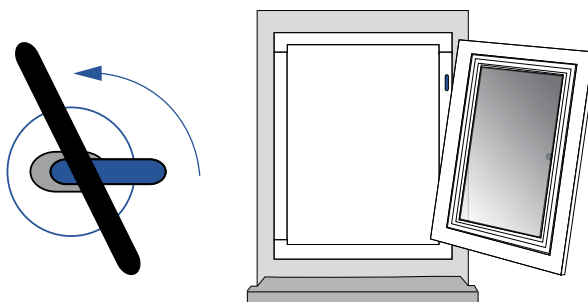

MALPOSITIONING OF THE SASH

IN ORDER TO PRESERVE THE LONG OPERATIVENESS OF YOUR WINDOW AND TO GUARANTEE SECURITY, IT IS IMPERATIVE TO OBSERVE THE DIRECTIVES LISTED BELOW.

DO NOT PLACE ANY OBJECTS BETWEEN THE SASH AND FRAME.

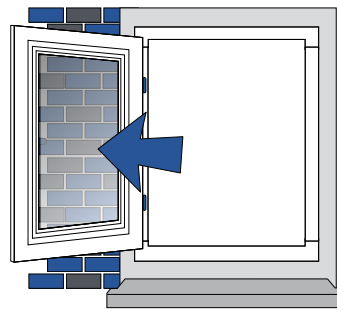
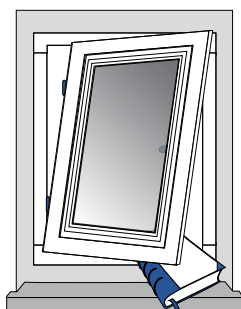

DO NOT ALLOW THE SASH TO HIT OR PRESS UP AGAINST THE WINDOW REVEAL.

THE WINDOW SASH MAY NOT BE BURDENED WITH ADDITIONAL WEIGHT.

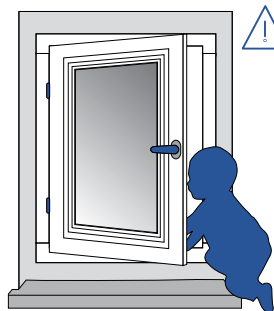
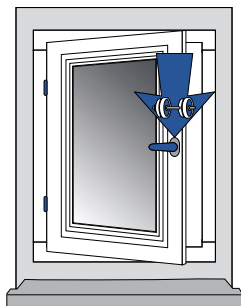

CAUTION! WHERE SMALL CHILDREN OR MENTALLY HADICAPPED PERSONS HAVE ACCESS TO THE WINDOW, THE SASH HAS TO BE SAFEGUARDED AGAINST TURNING, FOR EXAMPLE WITH A CHILD-SAFETY LOCK OR KEY-LOCKABLE HANDLES.

DO NOT LEAVE SASHES OPEN IN THE TURN POSITION DURING STRONG WINDS.

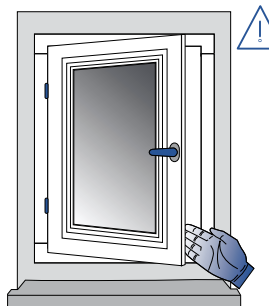
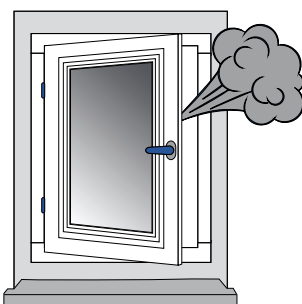

CAUTION! A SLAMMING SASH CAN LEAD TO INJURIES. WHILE CLOSING, DO NOT GRASP BETWEEN THE SASH AND FRAME.



ARX
The Hardware.



ARX handles

Handles for windows
Detailed information

HANDLES

The program of ARX Handles for windows is divided into three sections:

- Standard,
- Secustic – safety handle system: this program is distinguished by higher anti-burglary safety,
- Secustic with a lock: additional security against unauthorized opening of windows.

ARX Handles for windows are suitable for installation into different thickness of the profiles. Accordingly, three spindle sizes are used:

- 32 mm,
- 37 mm,
- 42 mm.

With ARX Handles set for balcony doors, a uniform appearance of the building hardware will be provided:

- set handle / handle,
- set handle / handle for balcony door with roller shutters.

Set for balcony doors are used for profile thickness of 68-78 mm. For thicker profiles, it's necessary to use longer screws for fixing the handles.

Certificate of Quality



ARX handles are made of quality material (aluminium) and protected by persistent surface protection of powder coating in different colors. Quality materials, modern manufacturing processes and product testing have led ARX handles to have a long lifetime and a 10 year warranty.



ARX handles have a quality certificate, the German Quality Assurance Institute. We are convinced that our products and services will continue to be a good guarantee for our future long-standing partnership and we look forward to further cooperation with you.

HANDLES

Window handles

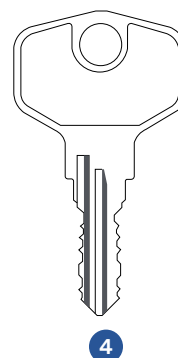
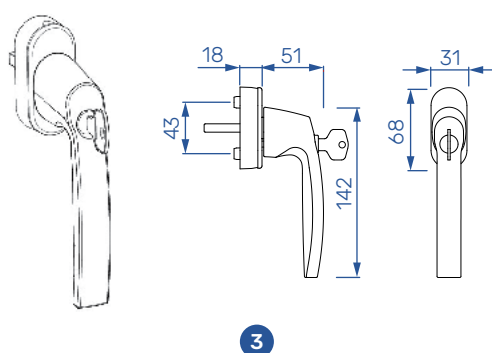
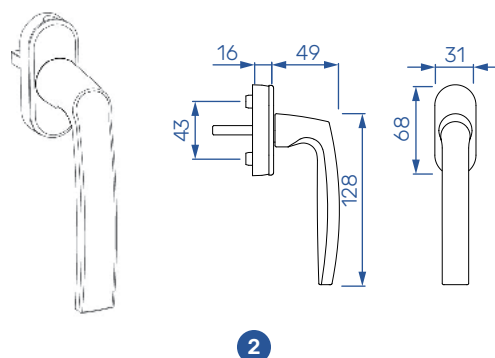
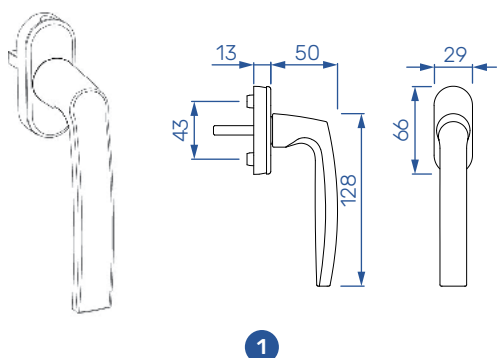

TYPE	DESCRIPTION	L	COLOR	PACK	MATERIAL
1	STANDARD HANDLE	32	F4 - dark bronze	20	1053207
		37	F1 - silver	20	1053212
		37	F4 - dark bronze	20	1053213
		37	F9 - titan	20	1053214
		37	RAL 9010 - white	20	1053215
		37	RAL 8707 - brown	20	1053216
		42	F1 - silver	20	1100839
		42	RAL 9010 - white	20	1058068
		42	RAL 8707 - brown	20	1058069
2	SECUSTIC HANDLE	37	F1 - silver	10	1053222
		37	F4 - dark bronze	10	1053223
		37	F9 - titan	10	1053224
		37	RAL 9010 - white	10	1053225
		37	RAL 8707 - brown	10	1053226
3	SECUSTIC HANDLE WITH SAFETY LOCK	37	F1 - silver	10	1053232
		37	F4 - dark bronze	10	1053235
		37	F9 - titan	10	1053236
		37	RAL 9010 - white	10	1053237
4	SPARE KEY FOR HANDLE	37	RAL 8707 - brown	10	1053238
		/	/	1	1119964

Balcony door handles

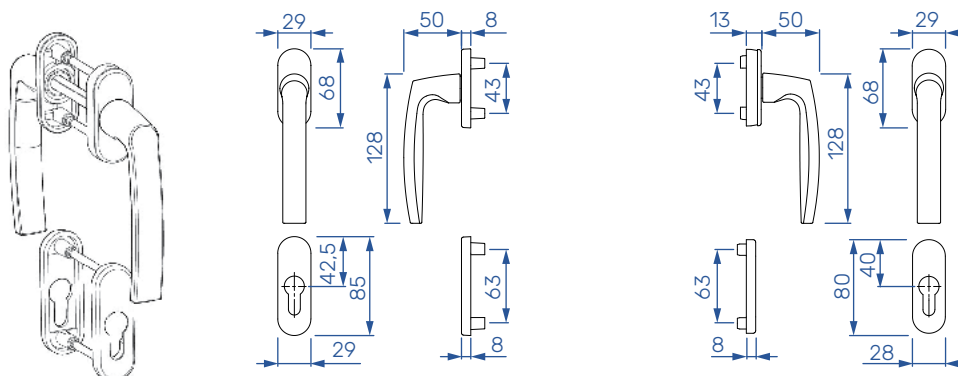

1

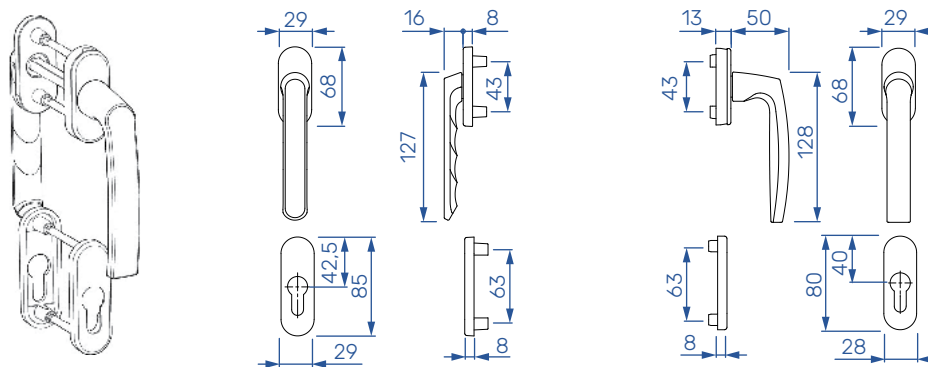

2



TYPE	DESCRIPTION	COLOR	PACK	MATERIAL
1	BALCONY DOOR HANDLE	F1 - silver	10	1053267
		F4 - dark bronze	10	1053268
		F9 - titan	10	1053269
		RAL 9010 - white	10	1053270
2	BALCONY DOOR HANDLE - ROLLER SHUTTERS	F1 - silver	10	1053281
		F4 - dark bronze	10	1053282
		F9 - titan	10	1053283
		RAL 9010 - white	10	1053284

HANDLES

Balcony door handles - basic

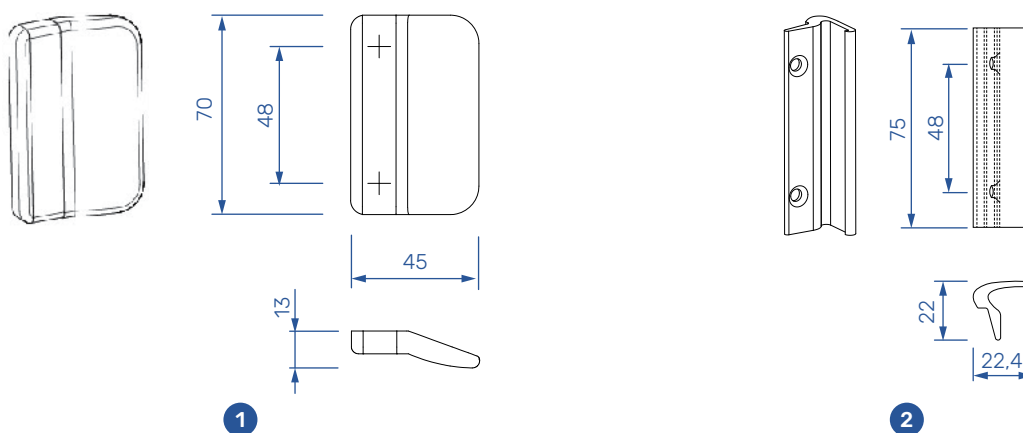

TYPE	DESCRIPTION	COLOR	PACK	MATERIAL
1	PVC material	RAL 8016 - brown	1	1053291
		RAL 9016 - white	1	1120683
		RAL 7016 - anthracite grey	1	1120684
2	ALU material	RAL 8019 - grey brown	1	1118689
		RAL 9016 - white	1	1117164
		RAL 7016 - anthracite grey	1	1117165

Rosette



TYPE	DESCRIPTION	COLOR	PACK	MATERIAL
1	FOR REMOVABLE HANDLE - PVC material	RAL 9016 - white	1	1053292
2	OVAL ROSETTE - ZAMAK material	RAL 8019 - grey brown	1	1081621
		RAL 9016 - white	1	1085631



Kovinoplastika Lož d.o.o.
Cesta 19. oktobra 57, Lož
1386 Stari trg pri Ložu
Slovenia

Follow us:

