

ARX
SPIN



Made in Europe

ARX
by KOVINOPLASTIKA LOŽ

10-YEAR
WARRANTY

Made in Europe

ARX
by KOVINOPLASTIKA LOŽ

ARX COAT
SURFACE
PROTECTION

ARX SPIN ALU

High quality, durable and simple
Turn & Tilt hardware for ALU windows
with 16 mm euro-groove

2024

KOVINOPLASTIKA LOŽ
— Since 1954 —

ARX
The Hardware.

Made in Europe
ARX
by KOVINOPLASTIKA LOŽ
10-YEAR
WARRANTY

Made in Europe
ARX
by KOVINOPLASTIKA LOŽ
ARX COAT
SURFACE
PROTECTION

Bring premium quality
into your home for a lifetime.

ARX PORTFOLIO



IFT Rosenheim
-Certificate of conformity
for ARX SPIN and ARX
DOOR LOCK.

ARX SPIN



Turn and tilt hardware solutions
for windows and balcony doors.

ARX
SPIN

ARX DOOR LOCK



Multipoint door lock solutions for
main and back entrance doors.

ARX
DOOR LOCK

ARX CASEMENT

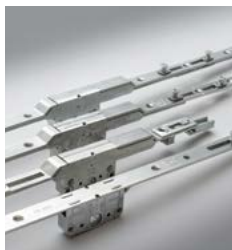

Solutions for
casement windows
-outward opening.

ARX
CASEMENT

ARX SLIDE



Sliding hardware
solutions for doors
and windows.

ARX
SLIDE

ARX ACCESSORIES



High quality, durable
and simple accessories
for windows and doors.

ARX
ACCESSORIES

Follow us:



www.arx-hardware.com

ARX
The Hardware.
03/2024

📍 Kovinoplastika Lož d.o.o.,
Lož, Cesta 19. oktobra 57,
SI-1386 Stari trg pri Ložu
☎ + 386 (0)170 95 100
✉ info@arx-hardware.com
🌐 www.arx-hardware.com

All the information in the following brochure has been carefully selected and verified. In the time of ever-growing technical progress and improvements, necessary changes constantly take place. We therefore thank you for your understanding, as we can not be held responsible for the correctness and completeness of the brochure content due to the reasons mentioned above. We reserve all the rights, especially the right to reproduce and transmit all parts of this publication.

B

ARX
The Hardware.



ARX – bring premium quality in your home for a lifetime

ARX is one of the leading providers of window and door hardware In Europe. Brand ARX is built on more than 70 years of foundation and experience of KOVINOPLASTIKA LOŽ. From that knowledge we are drawing the inspiration to create new and innovative solutions. Integrity in everything we do, quality of our work, and tailor-made building hardware solutions for our customers are the secret of our success and harmonious partnership with our customers. .

Window and door hardware tailored to your demands

Concerning costumers our goal is to provide functional, reliable & innovative experience of uncompromising quality that meets the highest standards of window and door hardware. We are focused on developing and applying best solutions in the field, while guaranteeing a flexible and efficient production process. Such approaches, in combination with the established knowledge, enable our experts to design and execute the most appropriate solutions tailored to your demands.

Our values, vision and mission

We are a team of engaged co-workers with the highest values like honesty, excellence, openness, endeavor and responsibility. We always strive to optimally use the knowledge and technologies, by which we develop and create the products and assemblies with higher added value, to ensure end users with a high level of security, wellbeing and best user experience. Our efforts have been rewarded by becoming established well-known development supplier. Being the best flexible and digitized niche solution developer and material modifier is our first and foremost mission.

CONTENTS

ABOUT	1
WHY ARX.....	6
BETTER THAN THE REST.....	7
STANDARDS AND CERTIFICATES.....	9
PRODUCT WARRANTY AND LIABILITY.....	10
HIGH-QUALITY, DURABLE, SIMPLE.....	12
SYMBOLS LEGEND	14
REGULATION OF PRODUCT WARRANTY	15
PROFILE RECOMMENDATION	16
TYPICAL HARDWARE SCHEMES	17
T&Ti face-fit hinge side	18
Fixed handle height	18
Centered / variable handle height.....	20
T&T face-fit hinge side.....	22
Fixed handle height	22
Centered / variable handle height.....	24
TURN - basic face-fit hinge side	26
Fixed handle height	26
TURN - standard face-fit hinge side.....	28
Fixed handle height	28
TURN - basic face-fit hinge side	30
Centered / variable handle height.....	30
TURN - standard face-fit hinge side.....	32
Centered / variable handle height.....	32
TILT - basic face-fit hinge side.....	34
Centered / variable handle height.....	34
TILT - standard face-fit hinge side	36
Centered / variable handle height.....	36
TURN - Second sash face-fit hinge side	38
Fixed handle height First sash T&Ti	38
Centered / variable handle height First sash T&Ti	40
Fixed handle height First sash T&T.....	42
Centered / variable handle height First sash T&T	44
Shootbolts - OHG.....	46
PRODUCT PORTFOLIO	49
T&T ESPAGNOLETTE M.....	50
Centered / variable handle height.....	50
T&T ESPAGNOLETTE M - larger backsets.....	51
Centered / variable handle height.....	51
T&T ESPAGNOLETTE M - larger backsets + lockable.....	52
Centered / variable handle height.....	52
ESPAGNOLETTE M	53
Centered / variable handle height.....	53

CONTENTS

T&T ESPAGNOLETTE KV	54
Fixed handle height	54
Fixed handle height	55
ESPAGNOLETTE	56
Fixed handle height	56
T&T ESPAGNOLETTE	57
Fixed handle height	57
T&T ESPAGNOLETTE	58
Fixed handle height	58
REVERSE ACTION ESPAGNOLETTE	59
Fixed handle height	59
FRENCH WINDOW ESPAGNOLETTE M	60
Centered / variable handle height	60
FRENCH WINDOW ESPAGNOLETTE KV	61
Fixed handle height	61
FRENCH WINDOW ESPAGNOLETTE T&T	62
Fixed handle height	62
FRENCH WINDOW ESPAGNOLETTE T&Ti	63
Fixed handle height	63
CORNER DRIVE	64
SASH-STAY GUIDE	66
Turn & tilt	66
Turn only - SECOND SASH	66
Sash stay guide - additional security	67
STAY ARM	68
Stay arm	68
Stay arm - additional security	69
Rebate stay arm	70
Rebate stay arm - ALU	70
Tilt stay	71
CENTER LOCK	72
With guide	72
Without guide	73
ESPAGNOLETTE EXTENSION	74
Lock bolt	74
French window lock bolt	74
Primary window	75
French window	75
SHOOTBOLT	76
OHG	76
HINGE SIDE	77
COVER CAPS	78
FRAME PARTS	80
Striker	80
T&T striker	80
T&Ti striker	80
Security striker	80
Striker - second sash	81
Mishandling device	81
Concealed center striker	81

CONTENTS

INSTALLATION INSTRUCTIONS	83
SASH PROFILE TREATMENT	84
Window-handle drilling	84
Gear-case routing	84
Lock-case drilling	85
FRAME PROFILE TREATMENT	86
Sash stay bearing K3	86
Corner pivot rest K3	86
INSTALLATION INSTRUCTIONS	87
Sash stay guide and center lock assembly	87
Tilt lock bolt and center lock assembly	87
T&T system with T&T espagnolette	88
T&Ti system with T&T M espagnolette	88
Slider	89
Anti slam device - tilt reduction	89
STRIKER JIGS INSTALLATION INSTRUCTIONS	90
Types	90
Instructions for use	91
HARDWARE ADJUSTMENT INSTRUCTIONS	92
Face-fit hinge side	92
LOCKING CAM ADJUSTMENT INSTRUCTIONS	93
OPERATING AND SYSTEM INSTRUCTIONS	94
Operation of window	94
Warning!	95
MAINTENANCE RECOMMENDATIONS	96
ARX HANDLES	97
HANDLES	98
Certificate of Quality	98
Window handles	99
Balcony door handles	100
Balcony door handles - basic	101
Rosette	101
NOTES	102



Quality-to-price ratio that ensures for the best market performance

Besides its distinctive quality, the ARX building hardware has an excellent quality-to-price ratio, providing you with a fast and effective strategy of winning market positions both in the Europe and globally. We provide the best quality, value, and service to meet our business partners' and users' needs, never leaving them in the lurch.

Accelerating the pace of innovation

Through the years we were never the silent observers of migration from old window and door hardware solutions to the nowadays highly technological ones, tailored for smart homes and buildings. Experiences, engineering knowledge and valuable partnerships helped us respond to and anticipate market needs, adapt our methods or materials, and innovate. Development of high-quality new products that have left a mark on the industry and decades of experience have shaped our unique path.

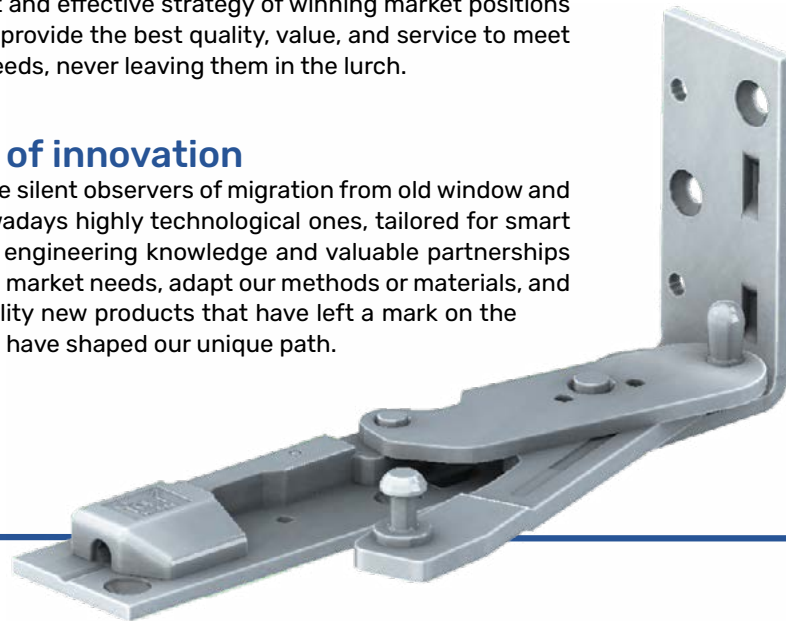

There is hardware,
and then there is **ARX**.

FOR FULL TERMS
AND CONDITIONS,
PLEASE VISIT:





Based on the huge versatility of our knowledge implemented into the design and applied research, we do not simply offer you products; we provide you with the following BENEFITS:



ARX 10-year warranty

For you to have complete confidence in our products, proven technologies, and expert skills, like we do, we provide you with a 10-year warranty on our building hardware functionality. The warranty applies exclusively to the use of the ARX building hardware, and to all manufacturers and suppliers of doors and windows who use ARX building hardware.



ARX surface protection and resistance coating ARX

Surface protection and resistance coating ARX Coat, provided by Kovinoplastika Lož is one of the best on the market.

Testing of corrosion resistant coating is carried out in our salt chamber according to standard ISO 9227 (NSS). It is done periodically, so we control the whole process. In case of deviations from perfect surface protection, immediate actions are applied to the manufacturing process to produce only the best products.

ARX building hardware suits the highest requirements of corrosion resistance as it reaches the 5th grade according to the standard EN 1670. That is an equivalent of 480 hours of salt spray.

ARX Coat is a proper surface protection, which provides good anti-corrosion durability and a trendy silver appearance, all due to our ARX internal processes.



Versatile hardware

ARX SPIN hardware can be used for PVC & timber windows and ALU windows with Eurogroove 16 mm. Many top design features offer a reliable operation, security, and functionality.

The main features of ARX SPIN hardware are:

- Best solutions for PVC & timber windows and ALU windows with Eurogroove 16 mm.
- High quality and smooth operation after years of use thanks to the ROLLING CAMS and the reduced contact area between the parts of hardware where sliding contact occurs.
- ARX SPIN for simple, fast and efficient installation with SNAP FUNCTION Slider & Straight cut.
- Wide range of applications and the possibility of combination with other product groups.
- High quality production and installation of individual hardware sets by using highly automated production.
- Easy adjustment for different window dimensions, shapes, and constructions.
- ARX SPIN for PVC profiles achieves the highest level of H3 according to the certification scheme QM328.
- ARX SPIN for TIMBER profiles achieves the level of H2 according to the certification scheme QM328.
- Guarantee of the Lifetime Warranty for functionality.
- Providing the 10-year warranty for the ARX Coat the highest corrosion protection Grade 5 according to EN1670 (480 hours exposure to salt spray).
- Possibility of R CAMS & RS cams:
 - a) R cams incorporate a regulatory function which allows installer or user to optimize the window compression by +/- 1.2 mm (hex key size 4), thereby improving the sealing properties of windows and balcony doors. Moreover, the R cams provide smoother operation to window users who only need to apply a minimum force to operate the handle.
 - b) RS cams provide superior level of security at closing points (with security strikers). Their height adjusts automatically to fit the air gap between sash and frame.



Manufacturer's standards and certificates

Our certificates present our dedication to the verifiable quality standards for processes and products. We are proud that we have repeatedly earned them. In every certificate, we see undisputed proof of long-term commitment to our partners, employees, and leadership.

MANAGEMENT SYSTEM CERTIFICATES:

- ISO 9001
- ISO 14001

CERTIFICATE OF CONFORMITY:

- IFT (QM 328)
- IFT (QM 342)

Kovinoplastika Lož acquired many important standards and certificates. Among them is EN1670 (grade 5) which has been held without interruption.



1. Introduction

According to the instructions of the Quality Association for Locks and Hardware (Gütegemeinschaft Schlösser und Beschläge), the VHBH Directive, issued on 11.12.2009 and the manufacturer's responsibility for its products, defined in the Consumer Protection Act (Consumer Protection Act of the Republic of Slovenia, paragraph 2, §4-11a), the following information about the turn-only and tilt&turn hardware for sashes must be observed. Failure to comply with the following information exempts the manufacturer from liability.

2. Product information and stipulated application

2.1 Quality Assurance Association for Locks and Hardware

(Gütegemeinschaft Schlösser und Beschläge) published in the VHBH Directive states that turn-only and tilt-and-turn hardware is hardware for turnable and tiltable sashes for windows in building construction.

This hardware is used for:

- bringing windows and sashes of windows, by activation of a handle, into a turning position,
- bringing windows and sashes of windows into a tilting position restricted by means of a scissor stay version.

Turn-only and turn&tilt hardware is used for installation in windows and balcony doors which are to be vertically installed, made from timber, PVC, aluminium or steel, and their corresponding combination.

According to the definition above, the regular function of the turn-only and turn & tilt hardware is closing the windows and sashes and opening them in different airing positions. When the sash is closed, the resistance of a gasket normally needs to be overcome.

2.2 Misuse – exclusion of liability

Misuse is not compliant with the basic purpose of hardware. Anti-theft windows and balcony doors for wet spaces and installation in aggressive and corrosive climate require special hardware with particularly defined characteristics, adjusted to individual building case.

2.3 Restrictions on the use

Open windows, sashes and balcony doors only have protective function and do not provide window fissure sealing, safety in heavy rain or snow, sound and thermal insulation and anti-theft protection. In windy weather and in case of draught, windows and sashes must be closed and bolted. Windy weather and draught logically mean that a window, a sash or balcony doors open and close automatically and uncontrollably in one of the open positions due to air pressure or whirlwind. The only way to make a window, sash or balcony doors fixedly open, is to install additional hardware elements.

2.4 Use in case of special requirements

Wind resistance of the closed and bolted window depends on the actual structure of window and balcony doors. In case a window (or a sash or balcony door) has to endure wind load, according to the DIN EN 12210 standards (in

particular pressure test p3), suitable hardware compilations are to be matched in relation to the respective window design and frame material, and each case individually agreed upon.

Anti-theft windows and balcony doors for wet spaces and installation in aggressive and corrosive climate require special hardware with particularly defined characteristics, adjusted to individual building case.

In general, the turn-only, turn & tilt and tilt & slide hardware meet the requirements according to the DIN 18025 standards, applicable to open-type buildings. To this end, particular agreements and adjustments regarding the appropriate hardware structure and its installation on windows and balcony doors are required.

3. Misuse of the product

Misuse of the turn & tilt and slide hardware for window and balcony doors (i.e. the use, non-compliant with intended use of the product) includes the following:

- inserting obstacles in the opening vicinity between the frame and sash and thus preventing the proper specified use,
- if, contrary to the instructions of use, the window or the sash is uncontrollably pushed toward the window reveals (e.g. because of the wind), causing damage or destruction of hardware, sash material or other parts of the window and the sash,
- additional load on the windows or balcony door sashes (if, for example, children swing on the windows or balcony door sashes),
- inserting a hand or an object into the rebate between the window and the sash when closing the window or balcony doors (risk of injury).

4. Product warranty

The manufacturer of ARX building hardware provides a 10-year warranty on functionality and surface protection, starting from the date of delivery of goods that is defined or can be defined and applies to the territory of the EU.

The warranty applies exclusively to the use of ARX building hardware components. In case of combining ARX building hardware components with components of other manufacturers, this warranty is void. The warranty applies to all manufacturers and suppliers of doors and windows who use ARX building hardware, starting from the purchasing date that is written on the invoice.

For more information please check warranty conditions on webpage - www.arx-hardware.com.

5. Product characteristics – manufacturer's instructions for use

5.1 Maximum sash weights

The maximum sash weight for individual hardware installation must not be exceeded. The construction element with the smallest possible permissible load defines the maximum weight of the sash. Application diagrams and

component classification must be considered.

5.2 Sash sizes

Application diagrams show the relationship between the permissible sash rebate heights, depending on various glass weights i.e. total glass weight. The calculated sash dimensions in the rebate or the sash formats (portrait and/or landscape format), as well as the maximum sash weight must not be exceeded under any circumstances.

5.3 Hardware combination

The manufacturer's regulations, regarding the combination of hardware (i.e. the application of additional stay arms, the hardware design for anti-theft windows and balcony door sashes), must be followed.

5.4 Hardware functionality

Permanent hardware functionality can be ensured by consistently following the rules below:

- Professional installation of hardware components must be performed according to the attached instructions for installation,
- hardware assembly in the process of window installation is to be done professionally,
- the window manufacturer must deliver the instructions for use and maintenance to the user, along with the guidelines regarding product warranty,
- hardware as a whole can only consist of the original ARX building hardware; any product warranty is excluded for simultaneously using hardware parts, not originally belonging to the ARX building hardware.

6. Product maintenance

Hardware components, important for safety, must be checked at least once a year for fitting tightness and tight fitting. If necessary, the fixing screws can be additionally fastened and the component parts replaced. The following maintenance work must be performed at least once a year:

- Greasing and functional control of all the movable parts and all the locking points of the turn-only and tilt&turn hardware.
- only the cleaning and maintenance agents, which do not reduce the anti-corrosion hardware protection, may be used.

Hardware a – particularly in the vicinity of the pivot rest and the scissor-stay, as well as replacement parts and the unhinging & hinging of the active sash – must be provided by highly-qualified experts. In case of surface treatment for windows and balcony doors (e.g. varnishing), all the hardware components must be excluded from treatment; they must also be protected against potential contamination, caused by surface treatment.

6.1 Maintaining the quality of surface treatment

In normal climate, the galvanized coating is not damaged by corrosion, as long as condensed water is not produced in hardware parts or if the condensed water quickly dries up.

In order to maintain long-lasting quality of surface treatment and prevent adverse corrosion effects, the instructions below must be followed:

- Hardware and window rebates must be thoroughly aired (particularly during the construction phase)

by making sure that the elements mentioned are not exposed to moisture and condensed water,

- hardware must be protected against any covers or contamination with building materials (e.g. roughcast, dust, cement and the like),
- aggressive vapours in the window rebate (e.g. formic acid and acetic acid, ammonia, amino- and ammonium compounds, aldehyde, phenol, tannic acid etc.) may quickly lead to corrosion of hardware components in combination with a small amount of condensed water; in case of aggressive vapours, thorough airing of rebates on the windows and balcony doors must be provided; this is particularly important for windows and balcony doors made of oak and other types of wood, containing a large amount of tannic acid,
- gaskets with acetic acid or acidic net structure or gaskets, containing the above mentioned ingredients must not be used, as the direct contact with the gasket and its vapours may corrode the hardware surface,
- hardware can only be cleaned with soft, ph-neutral cleaning agent in diluted form; aggressive, acidiferous cleaners or abrasive cleaning agents, containing the above mentioned ingredients, must not be used at any time.

7. Information and instructions

In order to carry out duties of informing and giving instructions and performing maintenance according to »Consumer Protection Act«, the following publications are available:

- »Catalogues« for designers and authorized dealers
- »Installation instructions« and »factory drawings« for manufacturers of windows and balcony doors,
- »instructions for maintenance and cleaning« and »Instructions for use« for investors and users.

In order to ensure the functionality of the turn-only, turn&tilt and slide hardware for windows and balcony doors, the following rules must be observed:

- The designers are required to obtain information from the manufacturer or the authorized dealer, regarding the products, and act accordingly,
- the authorized dealers must pay attention to product information and the information mentioned herein, along with installation instructions, factory drawings and instructions for maintenance and cleaning; they must obtain instructions for use from the manufacturer and pass them on to manufacturers of windows and balcony doors,
- the manufacturers of windows and balcony doors must consider all the relevant product information and ask the manufacturer or authorized dealer for maintenance and
- cleaning instructions in particular, along with instructions for use and pass them on to investors and users.

All information regarding turn & tilt, turn or tilt only hardware systems for windows and balcony doors made of PVC should be observed. In case of non-compliance the manufacturer is exempt from liability.



ARX Coat – High quality surface protection

ARX Coat surface protection gives excellent appearance to building hardware and simultaneously ensures long-term and durable surface. It maintains very high corrosion resistance in severe conditions and extreme climate, exceeding Grade 5 of BS EN1670 (480 hours exposure to salt spray), thereby guaranteeing long-term and simple use.

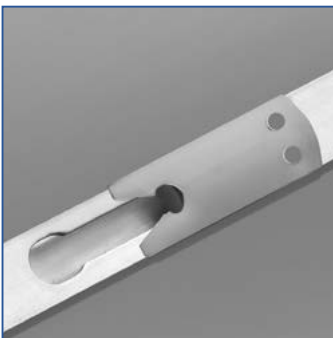

Stay guide with integrated anti-slam lock

Integrated tilt lock keeps the sash in tilted position, thus preventing sash slamming in windy conditions. It can be moved into alternative position, to reduce the tilt.



R cam

R cams incorporate a regulatory function which allows installer or user to optimize the window compression by +/- 1,2mm, thereby improving the sealing properties of windows and balcony doors. Moreover, the R cams provide smoother operation to window users who only need to apply a minimum force in order to operate the handle.



RS cam

RS cams provide superior level of security at closing points (with security strikers). Their height adjusts automatically to fit the air-gap between sash and frame. The compression can be regulated by +/- 0.8mm (hex key size 2.5 or spanner size 10). The rolling cam enables smoother and easier closing operation. RS cams can be used in combination with both security strikers or standard strikers.



Additional features

ARX Spin hardware is available in extensive variety of components, which can be combined into a number of turn & tilt solutions. ARX Spin therefore easily meets desires and requirements of different customers. For instance, a wide range of corner drives and shoot-bolts provides an excellent product choice to both very demanding and less stringent security requirements.

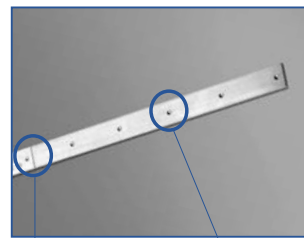

Range of use
Re-formed face plate

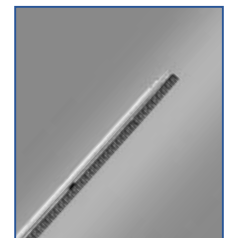

Reduced friction between driving rod and faceplate

The espagnolettes have been redesigned to reduce the contact between the gearplate and faceplate, thereby reducing potential damage to surface protection.

Uniform length of redesigned espagnolettes



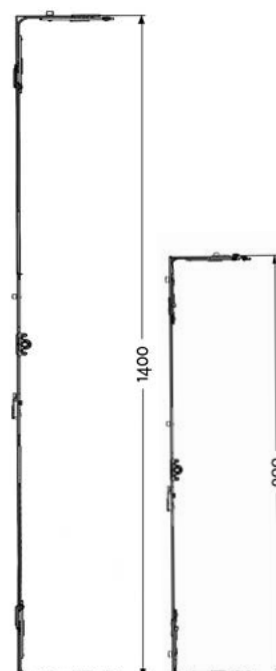







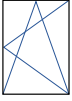

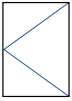

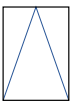

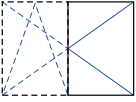

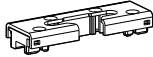

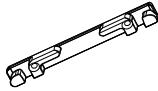



A special feature of ARX Spin hardware is also uniform length of its espagnolettes. A one-size espagnolette can fit a range of sash dimension, covering up to 50% of total requirement. Each espagnolette can be cropped within the marked cut-off area.



SRH 900 - 1400 mm
(50% Volume)

Symbols

In the part describing the ARX Spin, different symbols, diagrams and tables are used in order to provide a clear picture and demonstration of the hardware application. The meanings are as follows:

	Turn & tilt		R cam
	Turn only		RS cam
	Tilt only		Standard striker
	Turn only - sec. sash		Security striker
	Rebate sash height		T&Ti security striker
	Rebate sash width		T&T striker
	Handle height		Screws
	R cam		Mishandling device position
	RS cam		Packaging
	Night vent		Length / dimension
	Warning		Hardware shortening
	Max. sash mass		
	Material number		
	Orientation / position		

Abbreviation	Description	Units
SRH	SASH REBATE HEIGHT	mm
SRW	SASH REBATE WIDTH	mm
HH	HANDLE HEIGHT	mm
MS	MISHANDLING DEVICE POSITION	mm
BS	BACKSET	mm
LH	LOCK HOLE POSITION	mm
HL	HANDLE LENGTH	mm

Fixing guidelines

Screws

In order to fix hardware components, silver galvanized, steel construction screws of 4,2 x 25 mm (1134209) and 4,2 x 35 mm (1134210) are used. The 35 mm long screws are used for the hinges and the 25 mm long screws are used for all the rest of hardware. The window manufacturer must ensure sufficient fixing of hardware components. If necessary, the manufacturer of construction screws may also be included in the process of installing hardware.

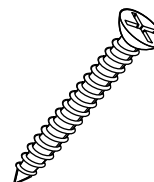

Fixing of hardware

Sash mass [Kg]	F [N]
60	1650
70	1900
80	2200
90	2450
100	2710
110	3000
120	3250
130	3500
140	3900
150	4200
160	4400
170	4710
180	5000
190	5300
200	5500

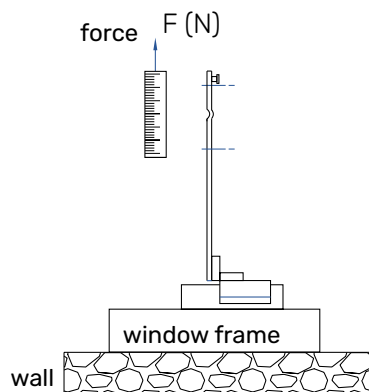

Fixing

When fixing safety relevant bearing hardware components (stay bearing and pivot rest), the vertical tractive force on the sash level must reach the values according to the following table (the tractive force values in dependence of the sash weight according to directive TBDK).

The necessity of reinforcement

The values in the table for sashes up to 80 kg in weight are normally achieved if high-quality screws are used for fixing and the fixing on the profile is performed through at least two profile walls. The thickness of the first profile wall must be at least 2,8 mm. For sash weights over 80 kg, a supplementary fixing into the reinforcement profile or profile insertions in accordance with the profile system, is necessary. Required values can be achieved without additional measures by using the bearing parts on sashes up to 100 kg in weight.

Gaskets with acetic acid net structure must not be used, as their use may lead to corrosion of hardware components. Guidelines regarding the window glazing technique must be followed.

The use of related hardware types

Different options within the individual hardware system (e.g. tilt hardware) must be considered according to the product information, purpose, misuse, product characteristics, maintenance, information and instructions in regard to the characteristics of the hardware assembly.

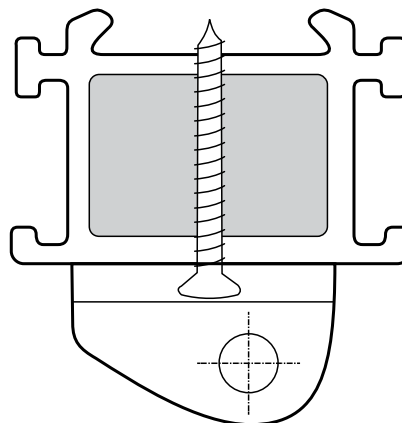

Profile dimensioning for ALU

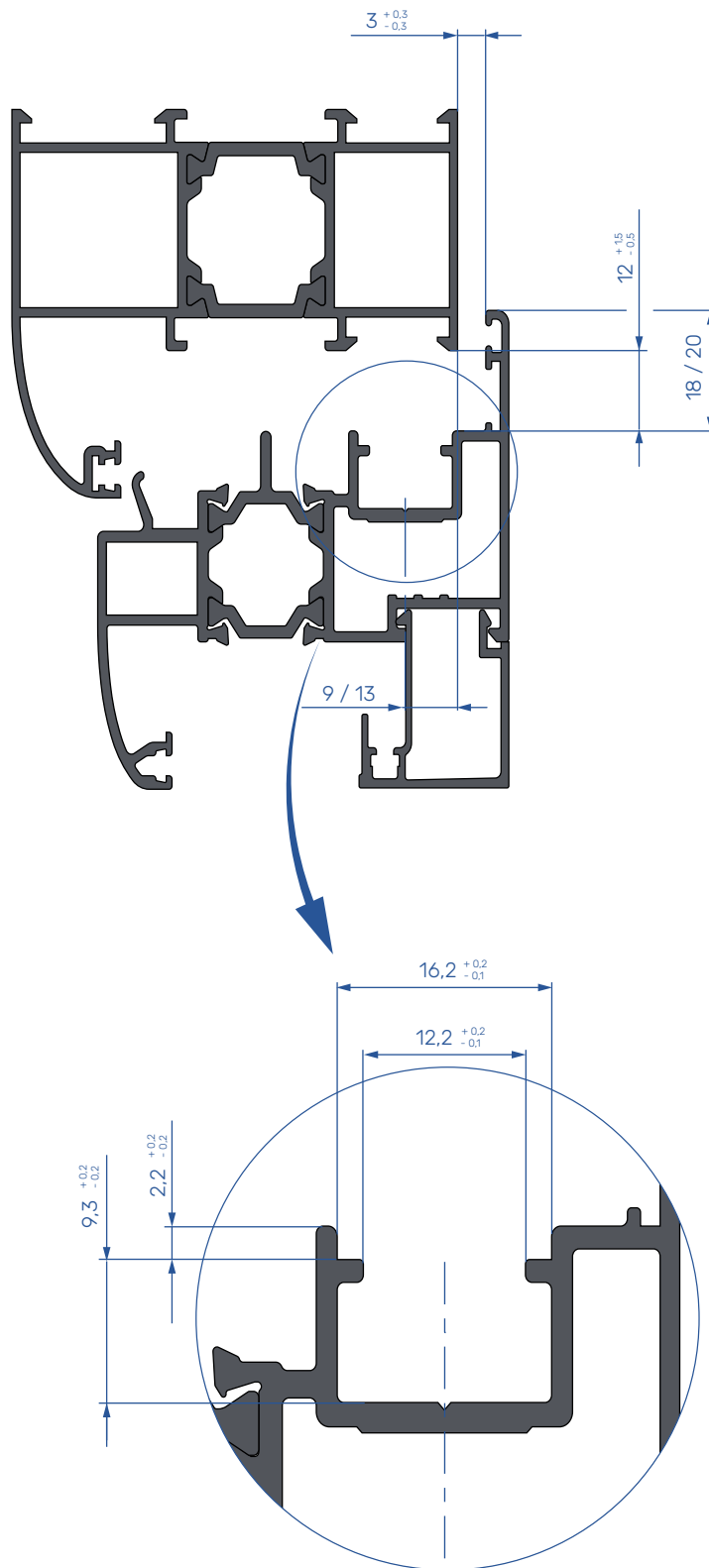



Typical hardware schemes

Basic schemes
Proposed guidelines

T&TI | FACE-FIT HINGE SIDE

Fixed handle height

1 T&T KV ESPAGNOLETTE BS 14,5 mm

Sash rebate height	Handle height	Length	Material
320 - 460 ¹⁾²⁾	120	320	1105430
461 - 600 ³⁾	170	410	1118431
601 - 800	263	520	1115131
801 - 1000	413	720	1115132
801 - 1000	413	720	1 R 1115133
1001 - 1200	513	920	1 R 1115134
1201 - 1400	563	1120	1 R 1115135
1401 - 1600	563	1320	1 R 1115136
1601 - 1800	563	1520	1 R 1115137
1601 - 1800	1000	1520	1 R 1115167
1801 - 2000	1000	1720	2 R 1115138
2001 - 2200	1000	1920	2 R 1115139
2201 - 2400	1000	2120	2 R 1115140

2 CORNER DRIVE - TOP

STANDARD CORNER DRIVE	1 R	1103158
SHORT CORNER DRIVE	1 R	1103162

3 SASH STAY GUIDE

Sash rebate width	Type / length	Material Nr.
250 - 410 ⁴⁾	150 / 290	1123308
411 - 610	250 / 470	1083038
611 - 810	350 / 670	1083039
811 - 1010	500 / 870	1 R 1083040
1011 - 1210	500 / 1070	1 R 1083041
1211 - 1400	500 / 1270	1 R 1083042

4 STAY ARM

SYSTEM 12/18-9

Sash rebate width	Type / length	Pos.	Material
250 - 410 ⁴⁾	150	L	1134891
		R	1134892
411 - 610	250	L	1104742
		R	1104743
611 - 810	350	L	1104744
		R	1104745
811 - 1400	500	L	1104746
		R	1104747

5 CENTER LOCK - VERTICAL

Sash rebate height	Length	Material
801 - 1200	500 / 550	2 R 1083058
1201 - 1600	800 / 850	2 R 1083059
1601 - 2200	1500 / 1550	3 R 1083060
2201 - 2400	1950 / 2000	4 R 1083064

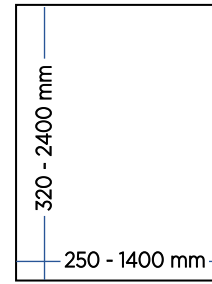
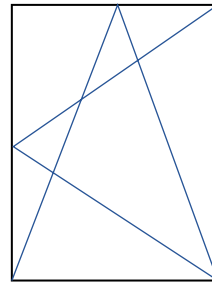

6 CENTER LOCK - HORIZONTAL

Sash rebate width	Length	Material
801 - 1200	400	1 R 1083061
1201 - 1400	600	1 R 1083062

7 CORNER DRIVE - BOTTOM

STANDARD CORNER DRIVE	1 RS	1100983
SHORT CORNER DRIVE	1 RS	1100986

8 STAY BEARING

STAY BEARING WITH PIN K3	1083250
--------------------------	---------

9 REBATE CORNER HINGE

SYSTEM 12/18-9

REBATE CORNER HINGE - L	1101236
REBATE CORNER HINGE - R	1101237

10 CORNER PIVOT REST

CORNER PIVOT REST K3	1083247
----------------------	---------

11 MISHANDLING DEVICE

SASH PART	1093907
FRAME PART AXIS 9	1098127

12 STRIKERS

T&Ti STRIKER AXIS 9 - L	11111000
T&Ti STRIKER AXIS 9 - R	1110999
STRIKER AXIS 9	1097952

13 COVER CAPS

STAY BEARING	PAGE 78
STAY ARM	PAGE 78
CORNER HINGE	PAGE 78
CORNER PIVOT REST	PAGE 78
CORNER PIVOT REST - FLAT	PAGE 78

¹⁾ WITH INTEGRATED CORNER DRIVE 1 RS ON BOTTOM

²⁾ MISHANDLING DEVICE NOT AVAILABLE

³⁾ MUST USE SHORT CORNER DRIVE 1100986 ON BOTTOM

⁴⁾ SRW = 250 - 340 mm, WITH SHORT CORNER DRIVE ON TOP

* SRH < 500 mm, move the anti-slam device to reduce the tilt

APPLICATION DIAGRAM

Sash rebate height (SRH) in mm

Sash rebate width (SRW) in mm

Glass mass [kg/m²]

- Impermissible size range
- 20 kg/m²
- 30 kg/m²
- 40 kg/m²
- 50 kg/m²
- 60 kg/m²
- 70 kg/m²

Conditions for the use of the application diagram:

- Bearing loads:
 - top hinge: 2710 N
 - bottom hinge: 2890 N
- The following values are to be observed with all window systems:
 - width/height ratio $U_{B/H} \leq 1,5$
 - sash size $H_{max} \leq 3 \text{ m}^2$
 - glass deduction dim. CG: $\geq 28 \text{ mm}$
 - profile weight PG: $\leq 3,25 \text{ kg/m}$

The application diagrams are generated according to IFT guidelines.

T&TI | FACE-FIT HINGE SIDE

Centered / variable handle height

1 T&T ESPAGNOLETTE M BS 14,5 mm

Sash rebate height	Handle height	Length	Material
420 - 660 ¹⁾	165 - 360	380	1083117
600 - 1000	300 - 500	720	1 R 1088473
900 - 1400	450 - 700	1120	1 R 1098964
1401 - 1800	701 - 900	1520	1 R 1098965
1601 - 2000	801 - 1000	1720	2 R 1098966
2001 - 2400	1001 - 1200	2120	2 R 1098967

2 CORNER DRIVE - TOP

STANDARD CORNER DRIVE	1 R	1103158
SHORT CORNER DRIVE	1 R	1103162

3 SASH STAY GUIDE

Sash rebate width	Type / length	Material Nr.
250 - 410 ²⁾	150 / 290	1123308
411 - 610	250 / 470	1083038
611 - 810	350 / 670	1083039
811 - 1010	500 / 870	1 R 1083040
1011 - 1210	500 / 1070	1 R 1083041
1211 - 1400	500 / 1270	1 R 1083042

4 STAY ARM

SYSTEM 12/18-9

Sash rebate width	Type / length	Pos.	Material
250 - 410 ²⁾	150	L	1134891
		R	1134892
411 - 610	250	L	1104742
		R	1104743
611 - 810	350	L	1104744
		R	1104745
811 - 1400	500	L	1104746
		R	1104747

5 CENTER LOCK - VERTICAL

Sash rebate height	Length	Material
801 - 1200	500 / 550	2 R 1083058
1201 - 1600	800 / 850	2 R 1083059
1601 - 2200	1500 / 1550	3 R 1083060
2201 - 2400	1950 / 2000	4 R 1083064

6 CENTER LOCK - HORIZONTAL

Sash rebate width	Length	Material
801 - 1200	400	1 R 1083061
1201 - 1400	600	1 R 1083062

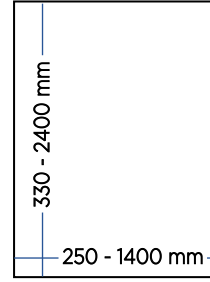
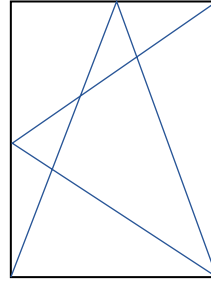

7 CORNER DRIVE - BOTTOM

STANDARD CORNER DRIVE 1 RS 1100983

8 STAY BEARING

STAY BEARING WITH PIN K3 1083250

9 REBATE CORNER HINGE

REBATE CORNER HINGE - L SYSTEM 12/18-9 1101236
REBATE CORNER HINGE - R 1101237

10 CORNER PIVOT REST

CORNER PIVOT REST K3 1083247

11 MISHANDLING DEVICE

SASH PART 1093907
FRAME PART AXIS 9 1098127

12 STRIKERS

T&Ti STRIKER AXIS 9 - L 11111000
T&Ti STRIKER AXIS 9 - R 1110999
STRIKER AXIS 9 1097952

13 COVER CAPS

STAY BEARING PAGE 78
STAY ARM PAGE 78
CORNER HINGE PAGE 78
CORNER PIVOT REST PAGE 78
CORNER PIVOT REST - FLAT PAGE 78

¹⁾ MISHANDLING DEVICE NOT AVAILABLE

²⁾ SRW = 250 - 340 mm, WITH SHORT CORNER DRIVE ON TOP

* SRH < 500 mm, move the anti-slam device to reduce the tilt

APPLICATION DIAGRAM

Sash rebate height (SRH) in mm

Sash rebate width (SRW) in mm

Glass mass [kg/m²]

- Impermissible size range
- 20 kg/m²
- 30 kg/m²
- 40 kg/m²
- 50 kg/m²
- 60 kg/m²
- 70 kg/m²

Conditions for the use of the application diagram:

- Bearing loads:
 - top hinge: 2710 N
 - bottom hinge: 2890 N
- The following values are to be observed with all window systems:
 - width/height ratio $0_{g/h} \leq 1.5$
 - sash size $H_{max} \leq 3 \text{ m}^2$
 - glass deduction dim. CG: $\geq 28 \text{ mm}$
 - profile weight PG: $\leq 3.25 \text{ kg/m}$

The application diagrams are generated according to IFT guidelines.

T&T | FACE-FIT HINGE SIDE

Fixed handle height

1 T&T KV ESPAGNOLETTE BS 14,5 mm

Sash rebate height	Handle height	Length	Material
550 - 600	260	410	1118431
601 - 800	263	520	1115131
801 - 1000	413	720	1115132
801 - 1000	413	720	1 R 1115133
1001 - 1200	513	920	1 R 1115134
1201 - 1400	563	1120	1 R 1115135
1401 - 1600	563	1320	1 R 1115136
1601 - 1800	563	1520	1 R 1115137
1601 - 1800	1000	1520	1 R 1115167
1801 - 2000	1000	1720	2 R 1115138
2001 - 2200	1000	1920	2 R 1115139
2201 - 2400	1000	2120	2 R 1115140

2 CORNER DRIVE

STANDARD CORNER DRIVE	1 R	1103158
SHORT CORNER DRIVE	1 R	1103162

3 SASH STAY GUIDE

Sash rebate width	Type / length	Material Nr.
250 - 410 ¹⁾	150 / 290	1123308
411 - 610	250 / 470	1083038
611 - 810	350 / 670	1083039
811 - 1010	500 / 870	1 R 1083040
1011 - 1210	500 / 1070	1 R 1083041
1211 - 1400	500 / 1270	1 R 1083042

4 STAY ARM

SYSTEM 12/18-9

Sash rebate width	Type / length	Pos.	Material
250 - 410 ¹⁾	150	L	1134891
		R	1134892
411 - 610	250	L	1104742
		R	1104743
611 - 810	350	L	1104744
		R	1104745
811 - 1400	500	L	1104746
		R	1104747

5 CENTER LOCK - VERTICAL

Sash rebate height	Length	Material
801 - 1200	500 / 550	2 R 1083058
1201 - 1600	800 / 850	2 R 1083059
1601 - 2200	1500 / 1550	3 R 1083060
2201 - 2400	1950 / 2000	4 R 1083064

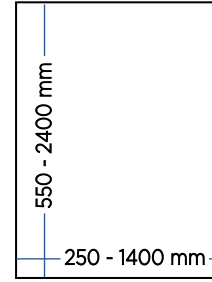
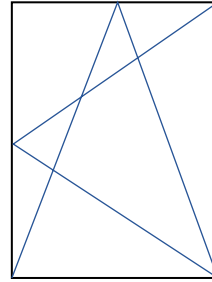

6 CENTER LOCK - HORIZONTAL

Sash rebate width	Length	Material
801 - 1200	500 / 550	2 R 1083058
1201 - 1400	800 / 850	2 R 1083059

7 TILT LOCK BOLT

TILT LOCK BOLT SRH < 1000 mm	1102388
TILT LOCK BOLT SRH > 1001 mm	1102391

8 STAY BEARING

STAY BEARING WITH PIN K3	1083250
--------------------------	---------

9 REBATE CORNER HINGE

SYSTEM 12/18-9

REBATE CORNER HINGE - L	1101236
REBATE CORNER HINGE - R	1101237

10 CORNER PIVOT REST

CORNER PIVOT REST K3	1083247
----------------------	---------

11 MISHANDLING DEVICE

SASH PART	1093907
FRAME PART AXIS 9	1098127

12 STRIKERS

T&T STRIKER AXIS 9	1097951
STRIKER AXIS 9	1097952

13 COVER CAPS

STAY BEARING	PAGE 78
STAY ARM	PAGE 78
CORNER HINGE	PAGE 78
CORNER PIVOT REST	PAGE 78
CORNER PIVOT REST - FLAT	PAGE 78

¹⁾ SRW = 250 - 340 mm, WITH SHORT CORNER DRIVE ON TOP

* SRH < 500 mm, move the anti-slam device to reduce the tilt

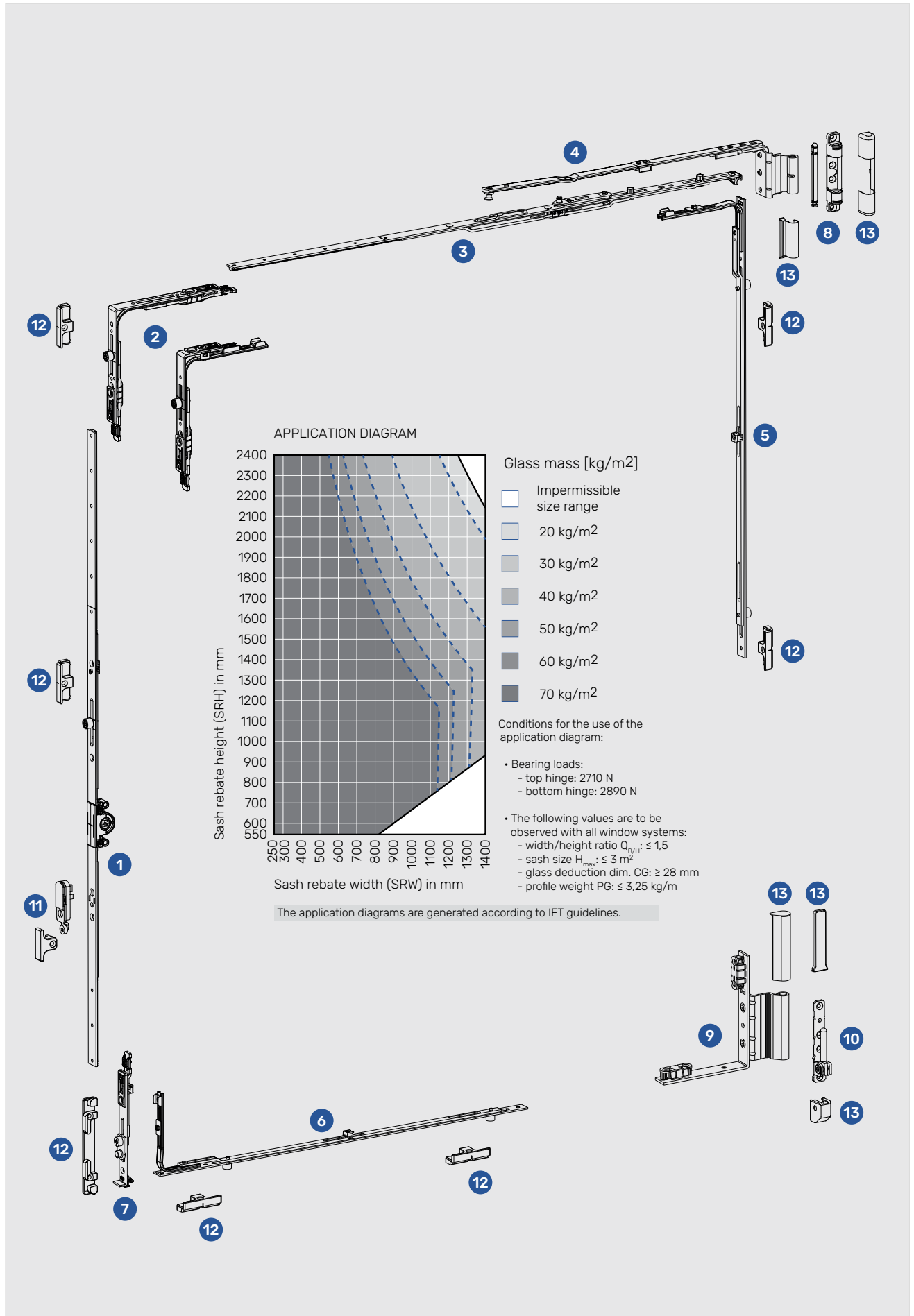

T&T | FACE-FIT HINGE SIDE

Centered / variable handle height

1 T&T ESPAGNOLETTE M BS 14,5 mm

Sash rebate height	Handle height	Length	Material
420 - 660 ¹⁾	210 - 360	360	1083117
600 - 1000	300 - 500	720	1 R 1088473
900 - 1400	450 - 700	1120	1 R 1098964
1401 - 1800	701 - 900	1520	1 R 1098965
1601 - 2000	801 - 1000	1720	2 R 1098966
2001 - 2400	1001 - 1200	2120	2 R 1098967

2 CORNER DRIVE

STANDARD CORNER DRIVE	1 R	1103158
SHORT CORNER DRIVE	1 R	1103162

3 SASH STAY GUIDE

Sash rebate width	Type / length	Material Nr.
250 - 410 ²⁾	150 / 290	1123308
411 - 610	250 / 470	1083038
611 - 810	350 / 670	1083039
811 - 1010	500 / 870	1 R 1083040
1011 - 1210	500 / 1070	1 R 1083041
1211 - 1400	500 / 1270	1 R 1083042

4 STAY ARM

SYSTEM 12/18-9

Sash rebate width	Type / length	Pos.	Material
250 - 410 ²⁾	150	L	1134891
		R	1134892
411 - 610	250	L	1104742
		R	1104743
611 - 810	350	L	1104744
		R	1104745
811 - 1400	500	L	1104746
		R	1104747

5 CENTER LOCK - VERTICAL

Sash rebate height	Length	Material
801 - 1200	500 / 550	2 R 1083058
1201 - 1600	800 / 850	2 R 1083059
1601 - 2200	1500 / 1550	3 R 1083060
2201 - 2400	1950 / 2000	4 R 1083064

6 CENTER LOCK - HORIZONTAL

Sash rebate width	Length	Material
801 - 1200	500 / 550	2 R 1083058
1201 - 1400	800 / 850	2 R 1083059

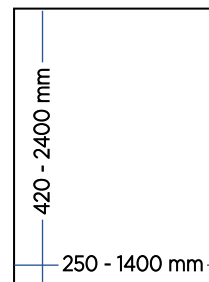
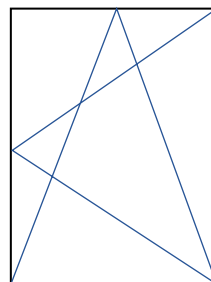

7 TILT LOCK BOLT

TILT LOCK BOLT SRH < 1000 mm	1102388
TILT LOCK BOLT SRH > 1001 mm	1102391

8 STAY BEARING

STAY BEARING WITH PIN K3	1083250
--------------------------	---------

9 REBATE CORNER HINGE

SYSTEM 12/18-9

REBATE CORNER HINGE - L	1101236
REBATE CORNER HINGE - R	1101237

10 CORNER PIVOT REST

CORNER PIVOT REST K3	1083247
----------------------	---------

11 MISHANDLING DEVICE

SASH PART	1093907
FRAME PART AXIS 9	1098127

12 STRIKERS

T&T STRIKER AXIS 9	1097951
STRIKER AXIS 9	1097952

13 COVER CAPS

STAY BEARING	PAGE 78
STAY ARM	PAGE 78
CORNER HINGE	PAGE 78
CORNER PIVOT REST	PAGE 78
CORNER PIVOT REST - FLAT	PAGE 78

¹⁾ MISHANDLING DEVICE NOT AVAILABLE

²⁾ SRW = 250 - 340 mm, WITH SHORT CORNER DRIVE ON TOP

* SRH < 500 mm, move the anti-slam device to reduce the tilt

APPLICATION DIAGRAM

Sash rebate height (SRH) in mm

Sash rebate width (SRW) in mm

Glass mass [kg/m²]

- Impermissible size range
- 20 kg/m²
- 30 kg/m²
- 40 kg/m²
- 50 kg/m²
- 60 kg/m²
- 70 kg/m²

Conditions for the use of the application diagram:

- Bearing loads:
 - top hinge: 2710 N
 - bottom hinge: 2890 N
- The following values are to be observed with all window systems:
 - width/height ratio Q_{gl}/H_{gl} : $\leq 1,5$
 - sash size $H_{gl,max}$: $\leq 3 \text{ m}^2$
 - glass deduction dim. CG: $\geq 28 \text{ mm}$
 - profile weight PG: $\leq 3,25 \text{ kg/m}$

The application diagrams are generated according to IFT guidelines.

TURN - BASIC | FACE-FIT HINGE SIDE

Fixed handle height

1 ESPAGNOLETTE BS 14,5 mm

Sash rebate height	Handle height	Length	Material
400 - 500 ¹⁾	170	500	2 R 1083129
501 - 600	170	600	2 R 1083130
601 - 700	263	700	2 R 1083131
701 - 800	263	800	2 R 1083132
801 - 900	413	900	2 R 1083133
901 - 1000	413	1000	2 R 1083134
1001 - 1100	513	1100	3 R 1083135
1101 - 1200	513	1200	3 R 1083136
1201 - 1300	563	1300	3 R 1083137
1301 - 1400	563	1400	3 R 1083138
1401 - 1500	563	1500	3 R 1083139
1501 - 1600	563	1600	3 R 1083140
1601 - 1700	563	1700	3 R 1083141
1701 - 1800	563	1800	4 R 1083142
1800 - 2000	1000	2000	4 R 1083143
2001 - 2200	1000	2200	4 R 1083144
2201 - 2400	1000	2400	4 R 1083145

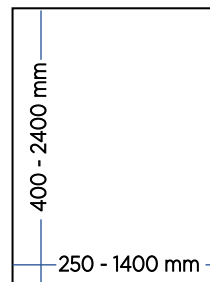
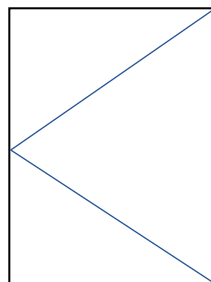

- 2 REBATE STAY ARM** SYSTEM 12/18-9
 REBATE STAY ARM - L 1104763
 REBATE STAY ARM - R 1104764

- 3 STAY BEARING**
 STAY BEARING WITH PIN K3 1083250

- 4 REBATE CORNER HINGE** SYSTEM 12/18-9
 REBATE CORNER HINGE - L 1101236
 REBATE CORNER HINGE - R 1101237

- 5 CORNER PIVOT REST**
 CORNER PIVOT REST K3 1083247

- 6 MISHANDLING DEVICE**
 SASH PART 1093907
 FRAME PART AXIS 9 1098127

- 7 STRIKERS**
 STRIKER AXIS 9 1097952

- 8 CONCEALED STRIKER**
 SASH PART 1127509
 FRAME PART AXIS 9 1127511

- 9 COVER CAPS**
 STAY BEARING [PAGE 78](#)
 REBATE STAY ARM / STAY ARM [PAGE 78](#)
 CORNER HINGE [PAGE 78](#)
 CORNER PIVOT REST [PAGE 78](#)
 CORNER PIVOT REST - FLAT [PAGE 78](#)

¹⁾ MISHANDLING DEVICE NOT AVAILABLE

* mishandling device serves as a sash lifter

* for SRW > 800 mm, next scheme (STANDARD) is recommended

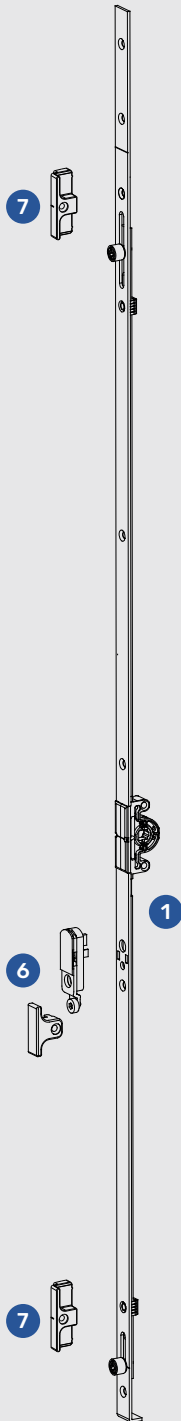

APPLICATION DIAGRAM

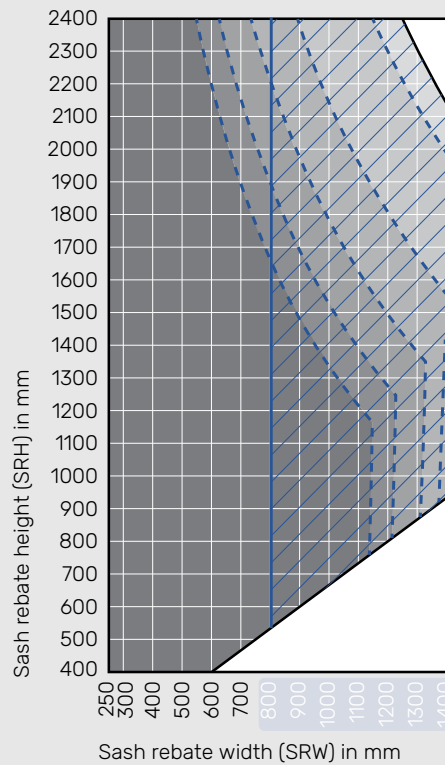

Glass mass [kg/m²]

- Impermissible size range
- 20 kg/m²
- 30 kg/m²
- 40 kg/m²
- 50 kg/m²
- 60 kg/m²
- 70 kg/m²

Conditions for the use of the application diagram:

- Bearing loads:
 - top hinge: 2710 N
 - bottom hinge: 2890 N
- The following values are to be observed with all window systems:
 - width/height ratio $Q_{b/h}$: $\leq 1,5$
 - sash size H_{max} : $\leq 3 \text{ m}^2$
 - glass deduction dim. CG: $\geq 28 \text{ mm}$
 - profile weight PG: $\leq 3,25 \text{ kg/m}$

The application diagrams are generated according to IFT guidelines.

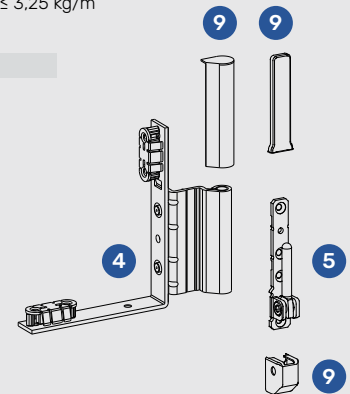
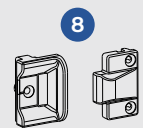
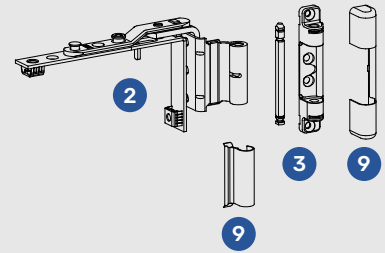

TURN - STANDARD | FACE-FIT HINGE SIDE

Fixed handle height

1 KV ESPAGNOLETTE BS 14,5 mm

Sash rebate height	Handle height	Lenght	Material
550 - 600	260	410	1118431
601 - 800	263	520	1115131
801 - 1000	413	720	1115132
801 - 1000	413	720	1 R 1115133
1001 - 1200	513	920	1 R 1115134
1201 - 1400	563	1120	1 R 1115135
1401 - 1600	563	1320	1 R 1115136
1601 - 1800	563	1520	1 R 1115137
1601 - 1800	1000	1520	1 R 1115167
1801 - 2000	1000	1720	2 R 1115138
2001 - 2200	1000	1920	2 R 1115139
2201 - 2400	1000	2120	2 R 1115140

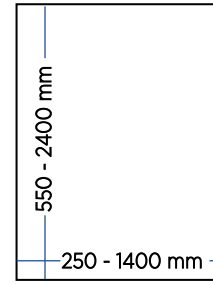
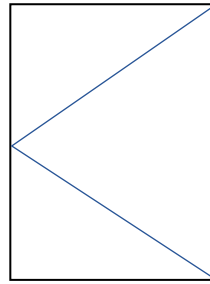

2 LOCK BOLT - BOTTOM

LOCK BOLT 140 1 R 1102394

3 LOCK BOLT - TOP

LOCK BOLT 140/90 1 R 1102395

4 CENTER LOCK

Sash rebate width	Lenght	Material
801 - 1200	500 / 550	2 R 1083058
1201 - 1400	800 / 850	2 R 1083059

5 REBATE STAY ARM

REBATE STAY ARM - L SYSTEM 12/18-9 1104763

REBATE STAY ARM - R 1104764

6 STAY BEARING

STAY BEARING WITH PIN K3 1083250

7 REBATE CORNER HINGE

REBATE CORNER HINGE - L SYSTEM 12/18-9 1101236

REBATE CORNER HINGE - R 1101237

8 CORNER PIVOT REST

CORNER PIVOT REST K3 1083247

9 MISHANDLING DEVICE

SASH PART 1093907

FRAME PART AXIS 9 1098127

10 STRIKERS

STRIKER AXIS 9 1097952

11 CONCEALED STRIKER

SASH PART 1127509

FRAME PART AXIS 9 1127511

12 COVER CAPS

STAY BEARING PAGE 78

REBATE STAY ARM / STAY ARM PAGE 78

CORNER HINGE PAGE 78

CORNER PIVOT REST PAGE 78

CORNER PIVOT REST - FLAT PAGE 78

* mishandling device serves as a sash lifter

APPLICATION DIAGRAM

Sash rebate height (SRH) in mm

Sash rebate width (SRW) in mm

Glass mass [kg/m²]

- Impermissible size range
- 20 kg/m²
- 30 kg/m²
- 40 kg/m²
- 50 kg/m²
- 60 kg/m²
- 70 kg/m²

Conditions for the use of the application diagram:

- Bearing loads:
 - top hinge: 2710 N
 - bottom hinge: 2890 N
- The following values are to be observed with all window systems:
 - width/height ratio $Q_{B/H} \leq 1,5$
 - sash size $H_{max} \leq 3 \text{ m}^2$
 - glass deduction dim. CG: $\geq 28 \text{ mm}$
 - profile weight PG: $\leq 3,25 \text{ kg/m}$

The application diagrams are generated according to IFT guidelines.

TURN - BASIC | FACE-FIT HINGE SIDE

Centered / variable handle height

1 ESPAGNOLETTE M BS 14,5 mm

Sash rebate height	Handle height	Lenght	Material
180 - 250 ¹⁾	90 - 125	180	1 R 1083163
251 - 500 ¹⁾	126 - 250	500	1 R 1083164
501 - 900	251 - 450	900	2 R 1083165
901 - 1400	451 - 700	1400	3 R 1083166
1401 - 1900	701 - 950	1900	4 R 1083167
1901 - 2400	951 - 1200	2400	4 R 1083168

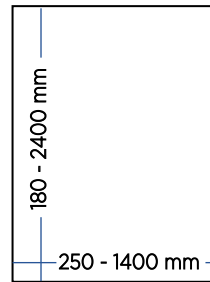
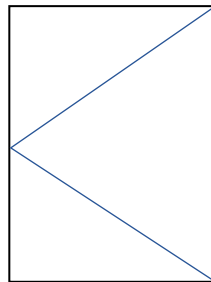

2 REBATE STAY ARM

REBATE STAY ARM - L
REBATE STAY ARM - R

SYSTEM 12/18-9
1104763
1104764

3 STAY BEARING

STAY BEARING WITH PIN K3

1083250

4 REBATE CORNER HINGE

REBATE CORNER HINGE - L
REBATE CORNER HINGE - R

SYSTEM 12/18-9
1101236
1101237

5 CORNER PIVOT REST

CORNER PIVOT REST K3

1083247

6 MISHANDLING DEVICE

SASH PART
FRAME PART AXIS 9

1093907
1098127

7 STRIKERS

STRIKER AXIS 9

1097952

8 CONCEALED STRIKER

SASH PART
FRAME PART AXIS 9

1127509
1127511

9 COVER CAPS

STAY BEARING
REBATE STAY ARM / STAY ARM
CORNER HINGE
CORNER PIVOT REST
CORNER PIVOT REST - FLAT

PAGE 78
PAGE 78
PAGE 78
PAGE 78
PAGE 78

¹⁾ MISHANDLING DEVICE NOT AVAILABLE

* mishandling device serves as a sash lifter

* for SRW > 800 mm, next scheme (STANDARD) is recommended

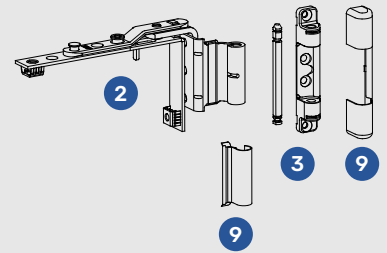
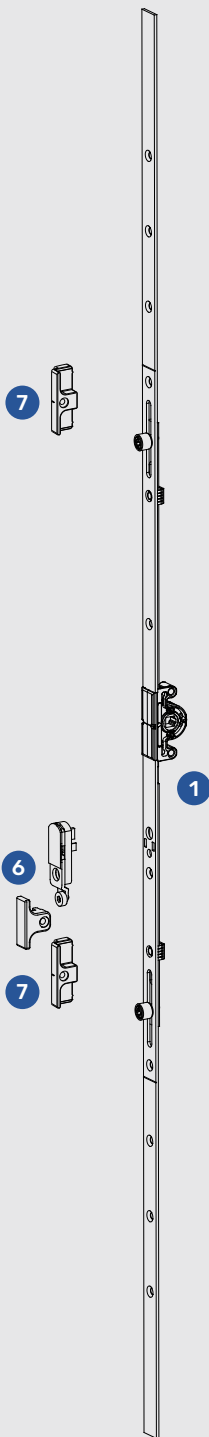

APPLICATION DIAGRAM

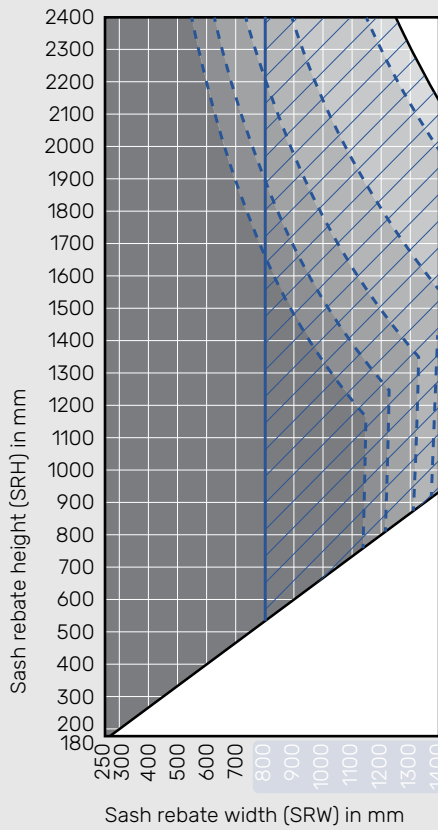

Glass mass [kg/m²]

- Impermissible size range
- 20 kg/m²
- 30 kg/m²
- 40 kg/m²
- 50 kg/m²
- 60 kg/m²
- 70 kg/m²

Conditions for the use of the application diagram:

- Bearing loads:
 - top hinge: 2710 N
 - bottom hinge: 2890 N
- The following values are to be observed with all window systems:
 - width/height ratio $Q_{B/H} \leq 1,5$
 - sash size $H_{max} \leq 3 \text{ m}^2$
 - glass deduction dim. CG: $\geq 28 \text{ mm}$
 - profile weight PG: $\leq 3,25 \text{ kg/m}$

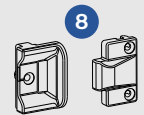

The application diagrams are generated according to IFT guidelines.

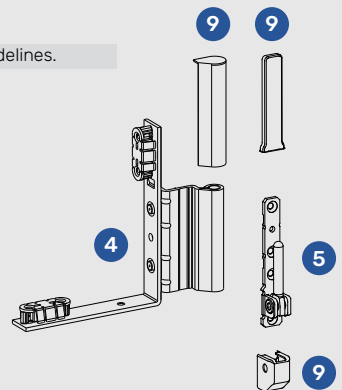

TURN - STANDARD | FACE-FIT HINGE SIDE

Centered / variable handle height

1 T&T ESPAGNOLETTE M BS 14,5 mm

Sash rebate height	Handle height	Lenght	Material
420 - 660 ¹⁾	210 - 360	380	1083117
601 - 1000	300 - 500	720	1 R 1088473
900 - 1400	450 - 700	1120	1 R 1098964
1401 - 1800	701 - 900	1520	1 R 1098965
1601 - 200	801 - 1000	1720	2 R 1098966
2001 - 2400	1001 - 1200	2120	2 R 1098967

2 LOCK BOLT - BOTTOM

LOCK BOLT 140 1 R 1102394

3 LOCK BOLT - TOP

LOCK BOLT 140/90 1 R 1102395

4 CENTER LOCK

Sash rebate width	Lenght	Material
801 - 1200	500 / 550	2 R 1083058
1201 - 1400	800 / 850	2 R 1083059

5 REBATE STAY ARM

SYSTEM 12/18-9
REBATE STAY ARM - L 1104763
REBATE STAY ARM - R 1104764

6 STAY BEARING

STAY BEARING WITH PIN K3 1083250

7 REBATE CORNER HINGE

SYSTEM 12/18-9
REBATE CORNER HINGE - L 1101236
REBATE CORNER HINGE - R 1101237

8 CORNER PIVOT REST

CORNER PIVOT REST K3 1083247

9 MISHANDLING DEVICE

SASH PART 1093907
FRAME PART AXIS 9 1098127

10 STRIKERS

STRIKER AXIS 9 1097952

11 CONCEALED STRIKER

SASH PART 1127509
FRAME PART AXIS 9 1127511

12 COVER CAPS

STAY BEARING [PAGE 78](#)
REBATE STAY ARM / STAY ARM [PAGE 78](#)
CORNER HINGE [PAGE 78](#)
CORNER PIVOT REST [PAGE 78](#)
CORNER PIVOT REST - FLAT [PAGE 78](#)

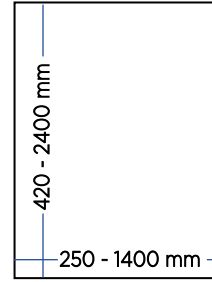
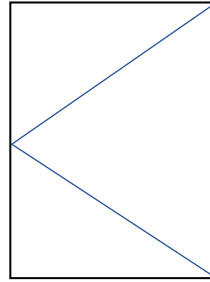

¹⁾ MISHANDLING DEVICE NOT AVAILABLE

* mishandling device serves as a sash lifter

APPLICATION DIAGRAM

Sash rebate height (SRH) in mm

Sash rebate width (SRW) in mm

Glass mass [kg/m²]

- Impermissible size range
- 20 kg/m²
- 30 kg/m²
- 40 kg/m²
- 50 kg/m²
- 60 kg/m²
- 70 kg/m²

Conditions for the use of the application diagram:

- Bearing loads:
 - top hinge: 2710 N
 - bottom hinge: 2890 N
- The following values are to be observed with all window systems:
 - width/height ratio $Q_{\text{SH/H}}$: $\leq 1,5$
 - sash size H_{max} : $\leq 3 \text{ m}$
 - glass deduction dim. CG: $\geq 28 \text{ mm}$
 - profile weight PG: $\leq 3,25 \text{ kg/m}$

The application diagrams are generated according to IFT guidelines.

TILT - BASIC | FACE-FIT HINGE SIDE

Centered / variable handle height

1 ESPAGNOLETTE M BS 14,5 mm

Sash rebate width	Handle width	Length	Material
250 - 500	125 - 250	500	1 R 1083164
501 - 900	251 - 450	900	2 R 1083165
901 - 1400	451 - 700	1400	3 R 1083166
1401 - 1900	701 - 950	1900	4 R 1083167
1901 - 2400	951 - 1200	2400	4 R 1083168

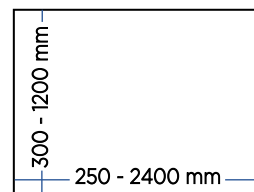
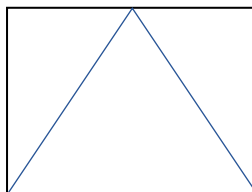

2 REBATE CENTER HINGE REBATE CENTER HINGE - adjustable

SYSTEM 12/18-9
1104760

3 STAY BEARING

STAY BEARING WITH PIN K3

1083250

4 TILT STAY

TILT STAY for GROOVE
TILT STAY for ESPAGNOLETTE

1099154
1099152

5 STRIKERS

STRIKER AXIS 9

1097952

6 COVER CAPS

STAY BEARING
REBATE CENTER HINGE / STAY ARM

PAGE 78
PAGE 78

* for SRH > 800 mm, next scheme (STANDARD) is recommended

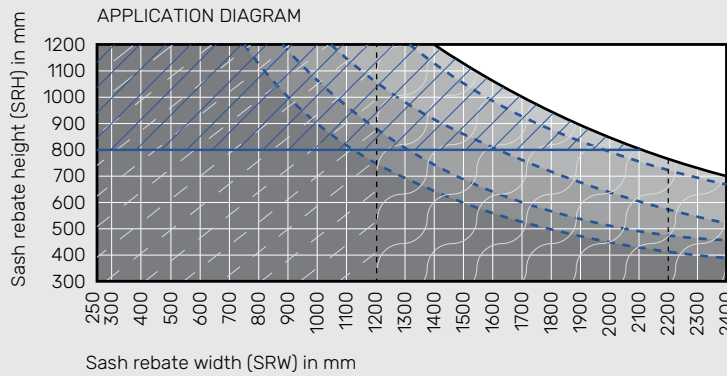
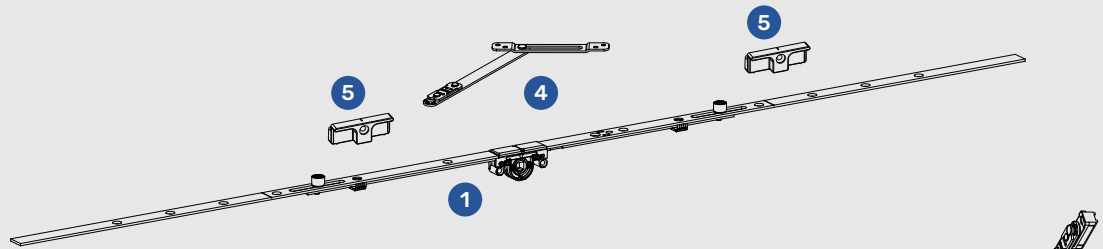

- Glass mass [kg/m²]
- Impermissible size range
 - 30 kg/m²
 - 40 kg/m²
 - 50 kg/m²
 - 60 kg/m²
 - 70 kg/m²



Conditions for the use of the application diagram:

- Glass deduction dim. CG: ≥ 28 mm,
- profile weight PG: ≤ 3,25 kg/m.

* The application diagrams are generated according to IFT guidelines.

! TILT STAYS MUST BE INSTALLED ON BOTH SIDES - recommended by directive FPKF

- ▨ ONE TILT STAY UP
- ▨ TWO TILT STAY UPS

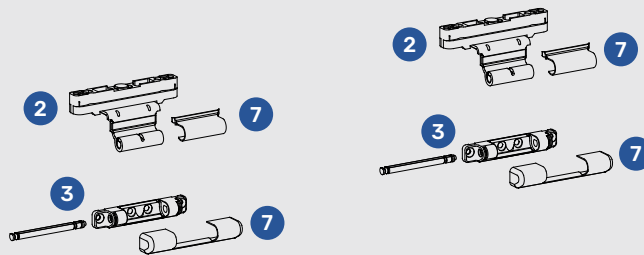

TILT - STANDARD | FACE-FIT HINGE SIDE

Centered / variable handle height

1 T&T ESPAGNOLETTE M BS 14,5 mm

Sash rebate width	Handle width	Lenght	Material
420 - 660	210 - 360	380	1083117
601 - 1000	300 - 500	720	1 R 1088473
900 - 1400	450 - 700	1120	1 R 1098964
1401 - 1800	701 - 900	1520	1 R 1098965
1601 - 2000	801 - 1000	1720	2 R 1098966
2001 - 2400	1001 - 1200	2120	2 R 1098967

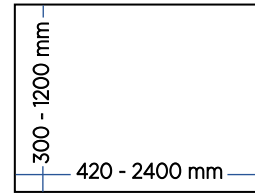
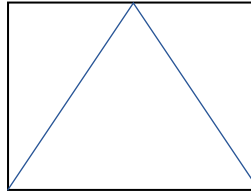

2 LOCK BOLT

LOCK BOLT 140 1 R 1102394

3 LOCK BOLT

LOCK BOLT 140/90 1 R 1102395

4 CENTER LOCK

Sash rebate height	Lenght	Material
801 - 1200	500/550	2 R 1083058

5 REBATE CENTER HINGE

REBATE CENTER HINGE - adjustable SYSTEM 12/18-9 1104760

6 STAY BEARING

STAY BEARING WITH PIN K3 1083250

7 TILT STAY

TILT STAY for GROOVE 1099154
TILT STAY for ESPAGNOLETTE / CENTER LOCK 1099152

8 STRIKERS

STRIKER AXIS 9 1097952

9 COVER CAPS

STAY BEARING PAGE 78
REBATE CENTER HINGE / STAY ARM PAGE 78

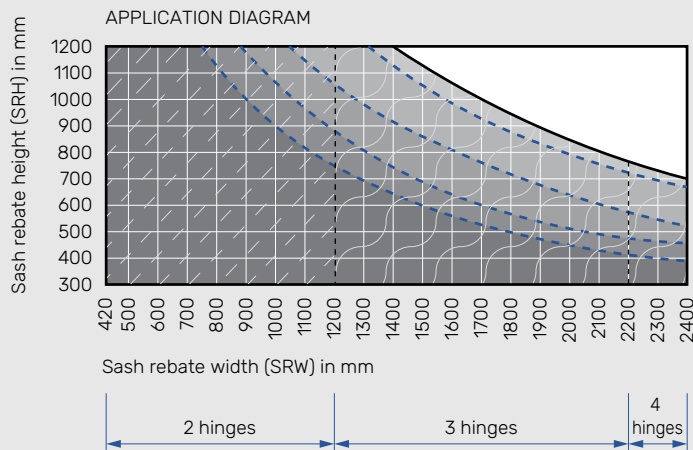
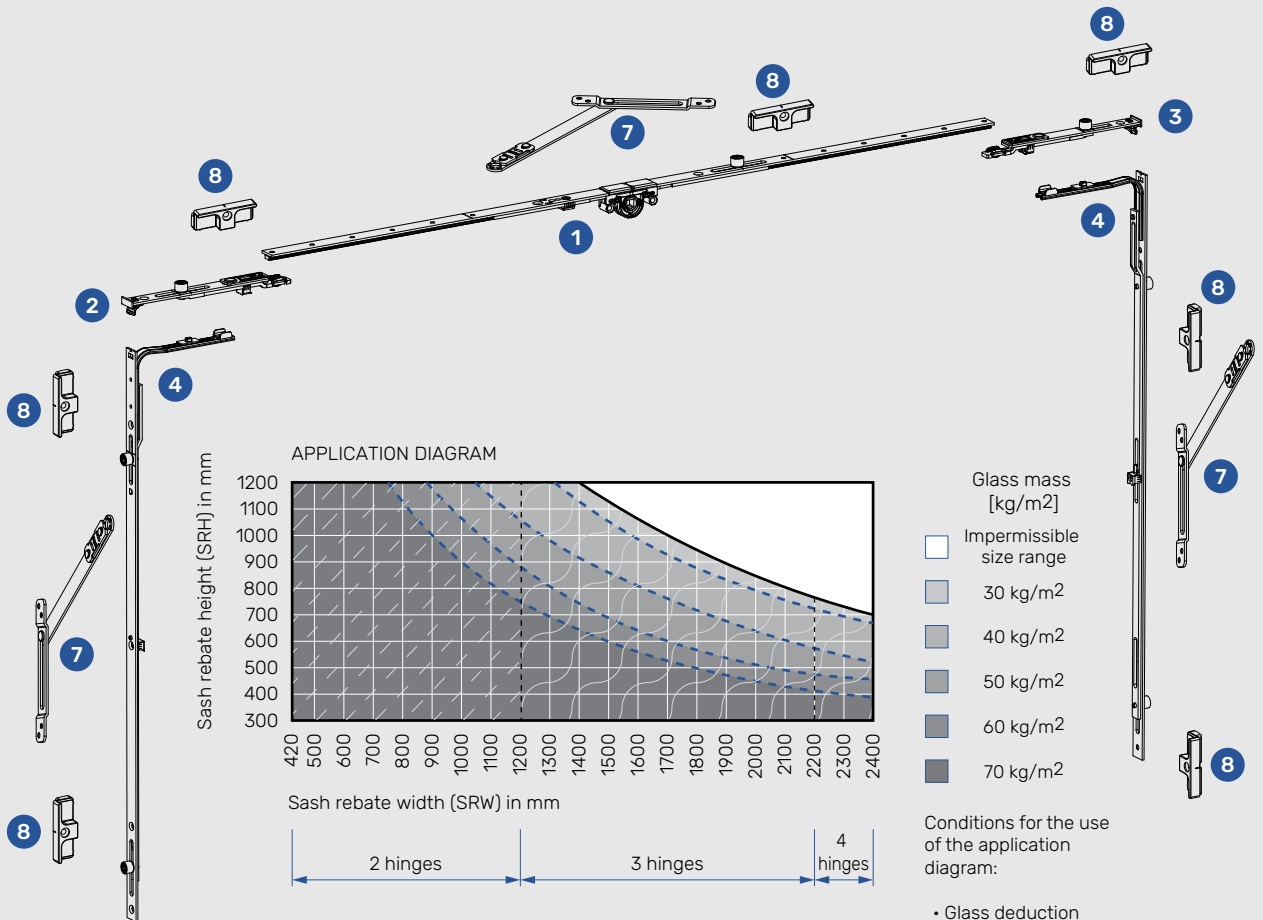

- Glass mass [kg/m²]
- Impermissible size range
 - 30 kg/m²
 - 40 kg/m²
 - 50 kg/m²
 - 60 kg/m²
 - 70 kg/m²

Conditions for the use of the application diagram:

- Glass deduction dim. CG: ≥ 28 mm,
- profile weight PG: ≤ 3,25 kg/m.

* The application diagrams are generated according to IFT guidelines.

! TILT STAYS MUST BE INSTALLED ON BOTH SIDES - recommended by directive FPKF

- ONE TILT STAY UP
- TWO TILT STAY UPS

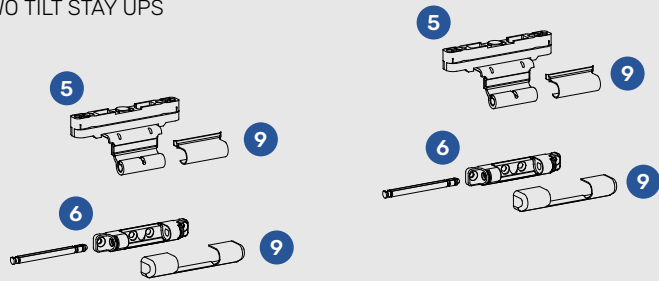

TURN - SECOND SASH | FACE-FIT HINGE SIDE

Fixed handle height | First sash T&Ti

1 FR. WIN. KV ESPAGNOLETTE

Sash rebate height	Handle height	Lenght	Material
460 - 600 ¹⁾²⁾	230	410	1118420
601 - 800 ²⁾	335	520	1118421
801 - 1000	490	720	1 R 1118423
1001 - 1200	335	920	1 R 1118424
1201 - 1400	335	1120	1 R 1118425
1401 - 1600	335	1320	1 R 1118426
1601 - 1800	335	1520	1 R 1118427
1801 - 2000	640	1720	2 R 1118428
2001 - 2200	640	1920	2 R 1118429
2201 - 2400	640	2120	2 R 1118430

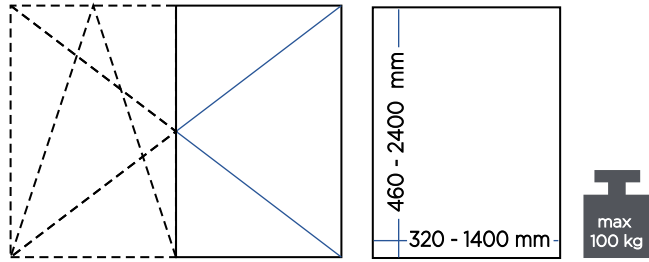

2 CORNER DRIVE - BOTTOM

STANDARD CORNER DRIVE	1 R	1103158
SHORT CORNER DRIVE	1 R	1103162

3 CORNER DRIVE - TOP

CORNER DRIVE	1 R	1103158
--------------	-----	---------

4 CENTER LOCK

Sash rebate width	Lenght	Material
801 - 1200	400	1 R 1083061
1201 - 1400	600	1 R 1083062

5 REBATE STAY ARM

REBATE STAY ARM - L	SYSTEM 12/18-9	1104763
REBATE STAY ARM - R		1104764

6 STAY BEARING

STAY BEARING WITH PIN K3	1083250
--------------------------	---------

7 REBATE CORNER HINGE

REBATE CORNER HINGE - L	SYSTEM 12/18-9	1101236
REBATE CORNER HINGE - R		1101237

8 CORNER PIVOT REST

CORNER PIVOT REST K3	1083247
----------------------	---------

9 MISHANDLING DEVICE

MISHANDLING DEVICE for espagnolette	1083295
-------------------------------------	---------

10 STRIKERS

STRIKER AXIS 9	1097952
----------------	---------

11 CONCEALED STRIKER

SASH PART	1127509
FRAME PART AXIS 9	1127511

12 COVER CAPS

STAY BEARING	PAGE 78
REBATE STAY ARM / STAY ARM	PAGE 78
CORNER HINGE	PAGE 78
CORNER PIVOT REST	PAGE 78
CORNER PIVOT REST - FLAT	PAGE 78

¹⁾ MUST USE SHORT CORNER DRIVE 1103162 ON BOTTOM

²⁾ MISHANDLING DEVICE NOT AVAILABLE

* position the R cams on upper corner drives into vertical position

APPLICATION DIAGRAM

Sash rebate height (SRH) in mm

Sash rebate width (SRW) in mm

Glass mass [kg/m²]

- Impermissible size range
- 20 kg/m²
- 30 kg/m²
- 40 kg/m²
- 50 kg/m²
- 60 kg/m²
- 70 kg/m²

Conditions for the use of the application diagram:

- Bearing loads:
 - top hinge: 2710 N
 - bottom hinge: 2890 N
- The following values are to be observed with all window systems:
 - width/height ratio $Q_{B/H}$: $\leq 1,5$
 - sash size H_{max} : $\leq 3 \text{ m}^2$
 - glass deduction dim. CG: $\geq 28 \text{ mm}$
 - profile weight PG: $\leq 3,25 \text{ kg/m}$

* The application diagrams are generated according to IFT guidelines.

TURN - SECOND SASH | FACE-FIT HINGE SIDE

Centered / variable handle height | First sash T&Ti

1 FR. WIN. ESPAGNOLETTE M

Sash rebate height	Handle height	Lenght	Material
500 - 680 ¹⁾	200 - 380	400	1098116
600 - 1000 ¹⁾	387 - 586	720	1 R 1098120
900 - 1400	350 - 550	1120	1 R 1098122
1401 - 1800	350 - 550	1520	1 R 1098123
1601 - 2000	350 - 550	1720	2 R 1098124
2001 - 2400	350 - 550	2120	2 R 1098125

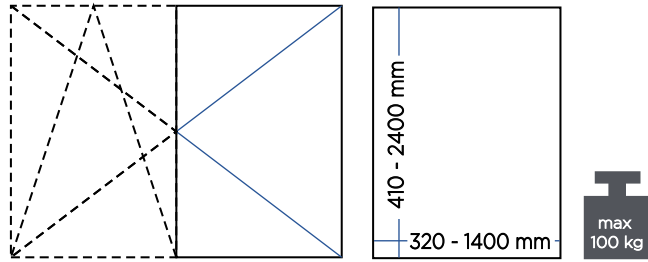

2 CORNER DRIVE - BOTTOM

STANDARD CORNER DRIVE 1 R 1103158

3 CORNER DRIVE - TOP

STANDARD CORNER DRIVE 1 R 1103158

4 CENTER LOCK

Sash rebate width	Lenght	Material
801 - 1200	400	1 R 1083061
1201 - 1400	600	1 R 1083062

5 REBATE STAY ARM

SYSTEM 12/18-9

REBATE STAY ARM - L 1104763
REBATE STAY ARM - R 1104764

6 STAY BEARING

STAY BEARING WITH PIN K3 1083250

7 REBATE CORNER HINGE

SYSTEM 12/18-9

REBATE CORNER HINGE - L 1101236
REBATE CORNER HINGE - R 1101237

8 CORNER PIVOT REST

CORNER PIVOT REST K3 1083247

9 MISHANDLING DEVICE

MISHANDLING DEVICE for espagnolette 1083295

10 STRIKERS

STRIKER AXIS 9 1097952

11 CONCEALED STRIKER

SASH PART 1127509
FRAME PART AXIS 9 1127511

12 COVER CAPS

STAY BEARING [PAGE 78](#)
REBATE STAY ARM / STAY ARM [PAGE 78](#)
CORNER HINGE [PAGE 78](#)
CORNER PIVOT REST [PAGE 78](#)
CORNER PIVOT REST - FLAT [PAGE 78](#)

¹⁾ MISHANDLING DEVICE NOT AVAILABLE

* position the R cams on upper corner drives into vertical position

APPLICATION DIAGRAM

Sash rebate height (SRH) in mm

Sash rebate width (SRW) in mm

Glass mass [kg/m²]

- Impermissible size range
- 20 kg/m²
- 30 kg/m²
- 40 kg/m²
- 50 kg/m²
- 60 kg/m²
- 70 kg/m²

Conditions for the use of the application diagram:

- Bearing loads:
 - top hinge: 2710 N
 - bottom hinge: 2890 N
- The following values are to be observed with all window systems:
 - width/height ratio $Q_{B/H} \leq 1,5$
 - sash size $H_{max} \leq 3 \text{ m}^2$
 - glass deduction dim. CG: $\geq 28 \text{ mm}$
 - profile weight PG: $\leq 3,25 \text{ kg/m}$

* The application diagrams are generated according to IFT guidelines.

TURN - SECOND SASH | FACE-FIT HINGE SIDE

Fixed handle height | First sash T&T

1 FR. WIN. KV ESPAGNOLETTE

Sash rebate height	Handle height	Lenght	Material
600 - 800 ¹⁾	335	520	1118421
801 - 1000	490	720	1 R 1118423
1001 - 1200	335	920	1 R 1118424
1201 - 1400	335	1120	1 R 1118425
1401 - 1600	335	1320	1 R 1118426
1601 - 1800	335	1520	1 R 1118427
1801 - 2000	640	1720	2 R 1118428
2001 - 2200	640	1920	2 R 1118429
2201 - 2400	640	2120	2 R 1118430

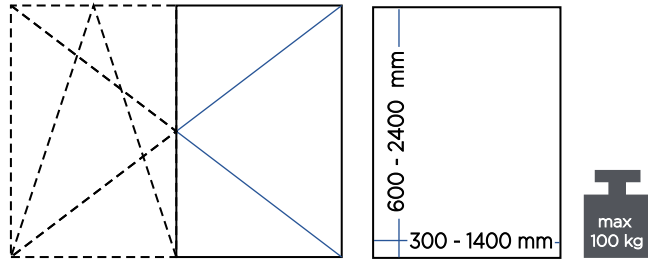

2 FR. WIN. T&T LOCK BOLT

T&T LOCK BOLT 1102621

3 FR. WIN. CONNECTOR with STRIKER

CONNECTOR WITH STRIKER 1110929

4 CENTER LOCK

Sash rebate width	Lenght	Material
801 - 1200	500 / 550	2 R 1083058
1201 - 1400	800 / 850	2 R 1083059

5 REBATE STAY ARM

REBATE STAY ARM - L SYSTEM 12/18-9 1104763
REBATE STAY ARM - R 1104764

6 STAY BEARING

STAY BEARING WITH PIN K3 1083250

7 REBATE CORNER HINGE

REBATE CORNER HINGE - L SYSTEM 12/18-9 1101236
REBATE CORNER HINGE - R 1101237

8 CORNER PIVOT REST

CORNER PIVOT REST K3 1083247

9 MISHANDLING DEVICE

MISHANDLING DEVICE for espagnolette 1083295

10 STRIKERS

STRIKER AXIS 9 1097952
SECOND SASH STRIKER for shootbolt AXIS 9 1097953

11 CONCEALED STRIKER

SASH PART 1127509
FRAME PART AXIS 9 1127511

12 COVER CAPS

STAY BEARING PAGE 78
REBATE STAY ARM / STAY ARM PAGE 78
CORNER HINGE PAGE 78
CORNER PIVOT REST PAGE 78
CORNER PIVOT REST - FLAT PAGE 78

¹⁾ MISHANDLING DEVICE NOT AVAILABLE

APPLICATION DIAGRAM

Sash rebate height (SRH) in mm

Sash rebate width (SRW) in mm

Glass mass [kg/m²]

- Impermissible size range
- 20 kg/m²
- 30 kg/m²
- 40 kg/m²
- 50 kg/m²
- 60 kg/m²
- 70 kg/m²

Conditions for the use of the application diagram:

- Bearing loads:
 - top hinge: 2710 N
 - bottom hinge: 2890 N
- The following values are to be observed with all window systems:
 - width/height ratio $Q_{B,H} \leq 1,5$
 - sash size $H_{max} \leq 3 \text{ m}^2$
 - glass deduction dim. CG: $\geq 28 \text{ mm}$
 - profile weight PG: $\leq 3,25 \text{ kg/m}$

* The application diagrams are generated according to IFT guidelines.

TURN - SECOND SASH | FACE-FIT HINGE SIDE

Centered / variable handle height | First sash T&T

1 FR. WIN. ESPAGNOLETTE M

Sash rebate height	Handle height	Lenght	Material
500 - 680 ¹⁾	290 - 380	400	1098116
600 - 1000 ¹⁾	387 - 586	720	1 R 1098120
900 - 1400	350 - 550	1120	1 R 1098122
1401 - 1800	350 - 550	1520	1 R 1098123
1601 - 2000	350 - 550	1720	2 R 1098124
2001 - 2400	350 - 550	2120	2 R 1098125

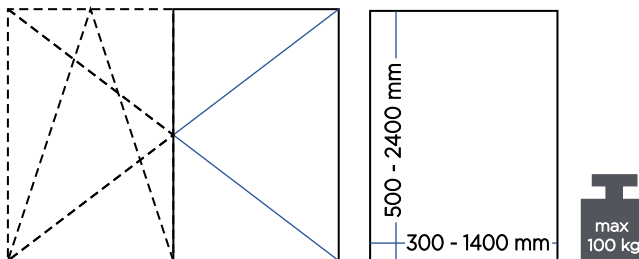

2 FR. WIN. T&T LOCK BOLT

T&T LOCK BOLT 1102621

3 FR. WIN. CONNECTOR with STRIKER

CONNECTOR WITH STRIKER 1110929

4 CENTER LOCK

Sash rebate width	Lenght	Material
801 - 1200	500 / 550	2 R 1083058
1201 - 1400	800 / 850	2 R 1083059

5 REBATE STAY ARM

SYSTEM 12/18-9

REBATE STAY ARM - L 1104763
REBATE STAY ARM - R 1104764

6 STAY BEARING

STAY BEARING WITH PIN K3 1083250

7 REBATE CORNER HINGE

SYSTEM 12/18-9

REBATE CORNER HINGE - L 1101236
REBATE CORNER HINGE - R 1101237

8 CORNER PIVOT REST

CORNER PIVOT REST K3 1083247

9 MISHANDLING DEVICE

MISHANDLING DEVICE for espagnolette 1083295

10 STRIKERS

STRIKER AXIS 9 1097952
SECOND SASH STRIKER for shootbolt AXIS 9 1097953

11 CONCEALED STRIKER

SASH PART 1127509
FRAME PART AXIS 9 1127511

12 COVER CAPS

STAY BEARING [PAGE 78](#)
REBATE STAY ARM / STAY ARM [PAGE 78](#)
CORNER HINGE [PAGE 78](#)
CORNER PIVOT REST [PAGE 78](#)
CORNER PIVOT REST - FLAT [PAGE 78](#)

¹⁾ MISHANDLING DEVICE NOT AVAILABLE

APPLICATION DIAGRAM

Sash rebate height (SRH) in mm

Sash rebate width (SRW) in mm

Glass mass [kg/m²]

- Impermissible size range
- 20 kg/m²
- 30 kg/m²
- 40 kg/m²
- 50 kg/m²
- 60 kg/m²
- 70 kg/m²

Conditions for the use of the application diagram:

- Bearing loads:
 - top hinge: 2710 N
 - bottom hinge: 2890 N
- The following values are to be observed with all window systems:
 - width/height ratio $Q_{B/H} \leq 1,5$
 - sash size $H_{max} \leq 3 \text{ m}^2$
 - glass deduction dim. CG: $\geq 28 \text{ mm}$
 - profile weight PG: $\leq 3,25 \text{ kg/m}$

* The application diagrams are generated according to IFT guidelines.

TURN - SECOND SASH | FACE-FIT HINGE SIDE

Shootbolts - OHG

1 SHOOTBOLT with striker - TOP
SHOOTBOLT WITH STRIKER 1083253

1a SHOOTBOLT with striker - TOP
SHOOTBOLT WITHOUT STRIKER 140 1083254

2 SHOOTBOLT with T&T striker - BOTTOM
SHOOTBOLT WITH T&T STRIKER 1083252

3 CENTER LOCK

Sash rebate width	Lenght	Material
801 - 1200	500 / 550	2 R 1083058
1201 - 1400	800 / 850	2 R 1083059

4 REBATE STAY ARM SYSTEM 12/18-9
REBATE STAY ARM - L 1104763
REBATE STAY ARM - R 1104764

5 STAY BEARING
STAY BEARING WITH PIN K3 1083250

6 REBATE CORNER HINGE SYSTEM 12/18-9
REBATE CORNER HINGE - L 1101236
REBATE CORNER HINGE - R 1101237

7 CORNER PIVOT REST
CORNER PIVOT REST K3 1083247

8 MISHANDLING DEVICE
MISHANDLING DEVICE - OHG 1083293

9 STRIKERS
STRIKER AXIS 9 1097952
STRIKER - OHG 1083207
SECOND SASH STRIKER for shootbolt AXIS 9 1097953

10 CONCEALED STRIKER
SASH PART 1127509
FRAME PART AXIS 9 1127511

11 COVER CAPS
STAY BEARING [PAGE 78](#)
REBATE STAY ARM / STAY ARM [PAGE 78](#)
CORNER HINGE [PAGE 78](#)
CORNER PIVOT REST [PAGE 78](#)
CORNER PIVOT REST - FLAT [PAGE 78](#)

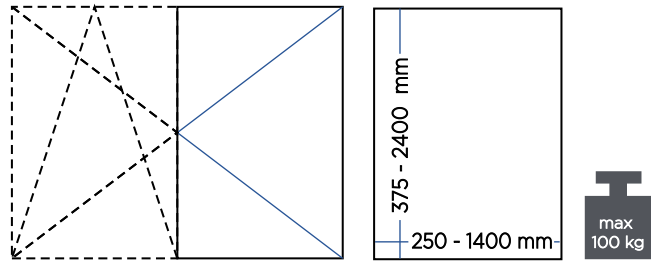

APPLICATION DIAGRAM

Sash rebate height (SRH) in mm

Sash rebate width (SRW) in mm

Glass mass [kg/m²]

- Impermissible size range
- 20 kg/m²
- 30 kg/m²
- 40 kg/m²
- 50 kg/m²
- 60 kg/m²
- 70 kg/m²

Conditions for the use of the application diagram:

- Bearing loads:
 - top hinge: 2710 N
 - bottom hinge: 2890 N
- The following values are to be observed with all window systems:
 - width/height ratio $Q_{B/H}$: $\leq 1,5$
 - sash size H_{max} : $\leq 3 \text{ m}^2$
 - glass deduction dim. CG: $\geq 28 \text{ mm}$
 - profile weight PG: $\leq 3,25 \text{ kg/m}$

* The application diagrams are generated according to IFT guidelines.





Product portfolio

Individual products
Detailed information

T&T ESPAGNOLETTE M

Centered / variable handle height

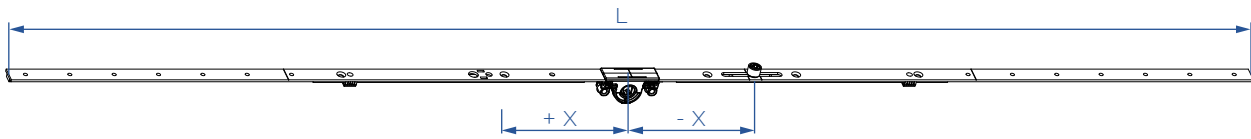

Backset 14,5 mm

SRH	HH	L	X	X	MS				PACK.	MATERIAL
420 - 660 ¹⁾	210 - 360	380	•	•	•	•	•	•	10	1083117
600 - 1000	300 - 500	720	-111	•	+ 38,5	1	2	10	1088473	
900 - 1400	450 - 700	1120	-111	•	+ 99,5	1	5	10	1098964	
1401 - 1800	701 - 900	1520	- 111	•	+ 99,5	1	7	10	1098965	
1601 - 2000	801 - 1000	1720	- 311	+ 309	-121,5	2	8	10	1098966	
2001 - 2400	1001 - 1200	2120	- 311	+ 309	- 121,5	2	10	10	1098967	

SRH	HH	L	X	X	X	X	MS				PACK.	MATERIAL
900 - 1400	450 - 700	1120	•	-211	+ 209	•	+99,5	2	6	10	1098973	
1401 - 1800	701 - 900	1520	•	-211	+ 209	•	+99,5	2	8	10	1098974	
1601 - 2000	801 - 1000	1720	•	- 311	+ 109	+ 559	-121,5	3	9	10	1098975	
2001 - 2400	1001 - 1200	2120	-631	- 311	+ 309	+ 629	-121,5	4	12	10	1098976	

SRH	HH	L	X	X	MS				PACK.	MATERIAL
600 - 1000	300 - 500	720	-111	•	+ 38,5	1	2	10	1101035	
900 - 1400	450 - 700	1120	-111	•	+ 99,5	1	5	10	1101036	
1401 - 1800	701 - 900	1520	- 111	•	+ 99,5	1	7	10	1101037	
1601 - 2000	801 - 1000	1720	- 311	+ 309	-121,5	2	8	10	1101038	
2001 - 2400	1001 - 1200	2120	- 311	+ 309	- 121,5	2	10	10	1101039	

SRH	HH	L	X	X	X	X	MS				PACK.	MATERIAL
900 - 1400	450 - 700	1120	•	- 211	+ 209	•	+ 99,5	2	6	10	1105851	
1401 - 1800	701 - 900	1520	•	- 211	+ 209	•	+ 99,5	2	8	10	1105852	
1601 - 2000	801 - 1000	1720	•	- 311	+ 109	+ 559	- 121,5	3	9	10	1105853	
2001 - 2400	1001 - 1200	2120	-631	- 311	+ 309	+ 629	- 121,5	4	12	10	1105854	

Backset 7,5 mm

SRH	HH	L	X	X	MS				PACK.	MATERIAL
470 - 820 ¹⁾	210 - 410	540	•	•	•	•	•	•	10	1083123
600 - 1000 ¹⁾	300 - 500	720	-111	•	•	1	2	10	1083124	
900 - 1400	450 - 700	1120	-111	•	+ 99,5	1	5	10	1083125	
1401 - 1800	701 - 900	1520	- 111	•	+ 99,5	1	7	10	1083126	
1601 - 2000	801 - 1000	1720	- 311	+ 309	- 121,5	2	8	10	1083127	
2001 - 2400	1001 - 1200	2120	- 311	+ 309	- 121,5	2	10	10	1083128	

MISHANDLING DEVICE NOT AVAILABLE

T&T ESPAGNOLETTE M - LARGER BACKSETS

Centered / variable handle height

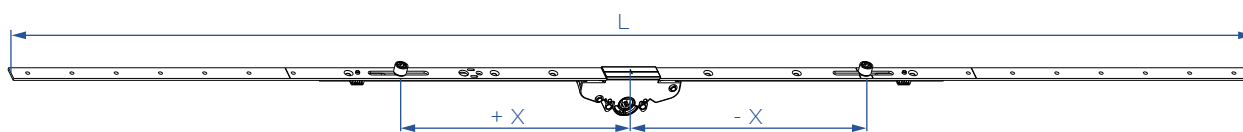

Backset 25 mm

SRH	HH	L	X	X	X	X	MS				PACK.	MATERIAL
420 - 660 ¹⁾	210 - 360	380	•	•	•	•	•	•	•	•	6	1104484
600 - 1000	300 - 500	720	•	•	-111	•	+38,5	1	2	6	6	1104485
900 - 1400	450 - 700	1120	•	+209	-211	•	+99,5	2	6	6	6	1104486
1401 - 1800	701 - 900	1520	•	+209	-211	•	+99,5	2	8	6	6	1104487
1601 - 2000	801 - 1000	1720	+559	+109	-311	•	-121,5	3	9	6	6	1104488
2001 - 2400	1001 - 1200	2120	+629	+309	-311	-631	-121,5	4	12	6	6	1104489

Backset 30 mm

SRH	HH	L	X	X	X	X	MS				PACK.	MATERIAL
420 - 660 ¹⁾	210 - 360	380	•	•	•	•	•	•	•	•	6	1107647
600 - 1000	300 - 500	720	•	•	-111	•	+38,5	1	2	6	6	1107648
900 - 1400	450 - 700	1120	•	+209	-211	•	+99,5	2	6	6	6	1107649
1401 - 1800	701 - 900	1520	•	+209	-211	•	+99,5	2	8	6	6	1107650
1601 - 2000	801 - 1000	1720	+559	+109	-311	•	-121,5	3	9	6	6	1107651
2001 - 2400	1001 - 1200	2120	+629	+309	-311	-631	-121,5	4	12	6	6	1107652

Backset 35 mm

SRH	HH	L	X	X	X	X	MS				PACK.	MATERIAL
420 - 660 ¹⁾	210 - 360	380	•	•	•	•	•	•	•	•	6	1107653
600 - 1000	300 - 500	720	•	•	-111	•	+38,5	1	2	6	6	1107654
900 - 1400	450 - 700	1120	•	+209	-211	•	+99,5	2	6	6	6	1107655
1401 - 1800	701 - 900	1520	•	+209	-211	•	+99,5	2	8	6	6	1107656
1601 - 2000	801 - 1000	1720	+559	+109	-311	•	-121,5	3	9	6	6	1107657
2001 - 2400	1001 - 1200	2120	+629	+309	-311	-631	-121,5	4	12	6	6	1107658

Backset 45 mm

SRH	HH	L	X	X	X	X	MS				PACK.	MATERIAL
420 - 660 ¹⁾	210 - 360	380	•	•	•	•	•	•	•	•	6	1104490
600 - 1000	300 - 500	720	•	•	-111	•	+38,5	1	2	6	6	1104491
900 - 1400	450 - 700	1120	•	+209	-211	•	+99,5	2	6	6	6	1104492
1401 - 1800	701 - 900	1520	•	+209	-211	•	+99,5	2	8	6	6	1104493
1601 - 2000	801 - 1000	1720	+559	+109	-311	•	-121,5	3	9	6	6	1104494
2001 - 2400	1001 - 1200	2120	+629	+309	-311	-631	-121,5	4	12	6	6	1104495

¹⁾ MISHANDLING DEVICE NOT AVAILABLE

T&T ESPAGNOLETTE M - LARGER BACKSETS + LOCKABLE

Centered / variable handle height

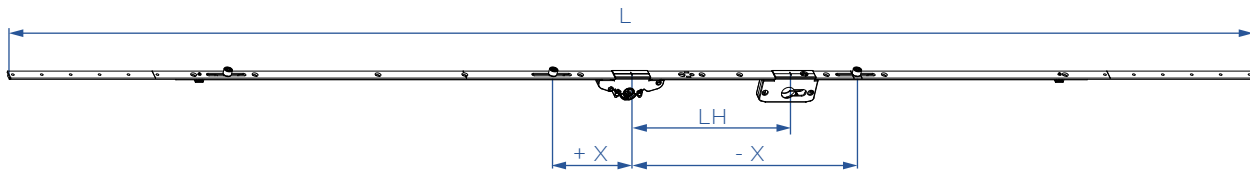

Backset 25 mm



SRH	HH	L	X	X	X	X	MS	LH		PACK.	MATERIAL	
1601 - 2000	801 - 1000	1720	+559	+109	-311	•	-121,5	220	3	10	6	1104477
2001 - 2400	1001 - 1200	2120	+629	+309	-311	-631	-121,5	220	4	13	6	1104480

Backset 30 mm



SRH	HH	L	X	X	X	X	MS	LH		PACK.	MATERIAL	
1601 - 2000	801 - 1000	1720	+559	+109	-311	•	-121,5	220	3	10	6	1107659
2001 - 2400	1001 - 1200	2120	+629	+309	-311	-631	-121,5	220	4	13	6	1107661

Backset 35 mm



SRH	HH	L	X	X	X	X	MS	LH		PACK.	MATERIAL	
1601 - 2000	801 - 1000	1720	+559	+109	-311	•	-121,5	220	3	10	6	1107662
2001 - 2400	1001 - 1200	2120	+629	+309	-311	-631	-121,5	220	4	13	6	1107663

Backset 45 mm



SRH	HH	L	X	X	X	X	MS	LH		PACK.	MATERIAL	
1601 - 2000	801 - 1000	1720	+559	+109	-311	•	-121,5	220	3	10	6	1104482
2001 - 2400	1001 - 1200	2120	+629	+309	-311	-631	-121,5	220	4	13	6	1104483

ESPAÑOLETTE M

Centered / variable handle height

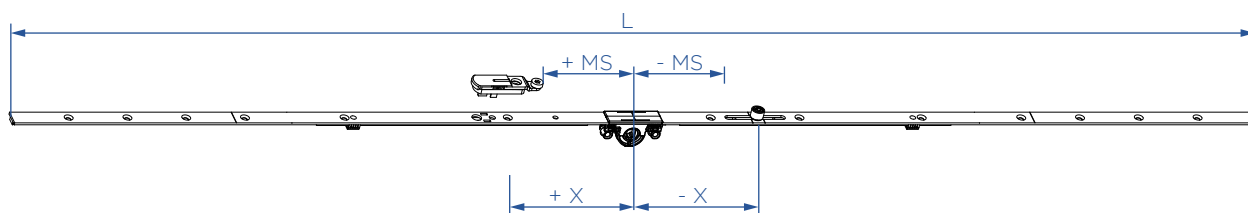

Backset 14,5mm

SRH	HH	L	X	X	X	X	MS				PACK.	MATERIAL
180 - 250 ¹⁾²⁾	90 - 125	180	•	- 65	•	•	•	1	2	20	1083163	
251 - 500 ¹⁾	126 - 250	500	•	- 76	•	•	•	1	6	10	1083164	
501 - 900	251 - 450	900	•	- 201	+ 199	•	- 128,5	2	12	10	1083165	
901 - 1400	451 - 700	1400	•	- 401	+ 112	+ 399	- 128,5	3	16	10	1083166	
1401 - 1900	701 - 950	1900	- 651	- 251	+ 249	+ 649	+ 89,5	4	20	10	1083167	
1901 - 2400	951 - 1200	2400	- 901	- 351	+ 349	+ 899	+ 89,5	4	20	10	1083168	

Backset 7,5 mm

SRH	HH	L	X	X	X	X	MS				PACK.	MATERIAL
251 - 500 ¹⁾	126 - 250	500	•	•	+ 74	•	•	1	6	10	1083169	
501 - 900	251 - 450	900	•	- 201	+ 199	•	- 128,5	2	12	10	1083170	
901 - 1400	451 - 700	1400	•	- 401	+ 112	+ 399	- 128,5	3	16	10	1083171	
1401 - 1900	701 - 950	1900	- 651	- 251	+ 249	+ 649	+ 89,5	4	20	10	1083172	
1901 - 2400	951 - 1200	2400	- 901	- 351	+ 349	+ 899	+ 89,5	4	20	10	1083173	

¹⁾ MISHANDLING DEVICE NOT AVAILABLE

²⁾ HARDWARE SHORTENING NOT POSSIBLE

T&T ESPAGNOLETTE KV

Fixed handle height

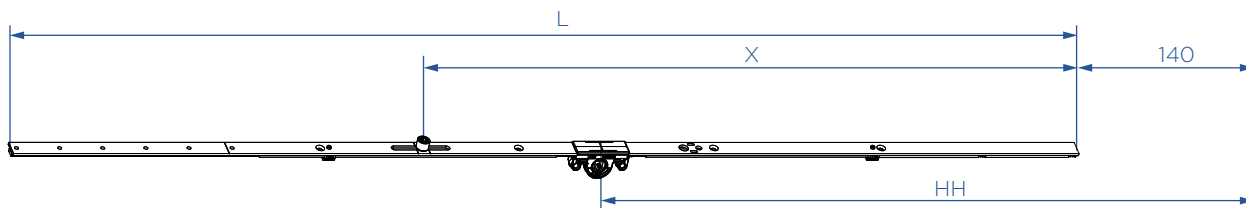

Backset 14,5 mm

SRH	HH	L	X	X	MS			PACK.	MATERIAL
320 - 460 ¹⁾³⁾	120	320	•	•	•	•	1	10	1083081
320 - 460 ¹⁾²⁾⁴⁾	120	320	•	•	•	•	2	10	1105430
461 - 600 ⁵⁾	170	410	•	•	168	•	1	10	1118431
601 - 800	263	520	•	•	176	•	1	10	1115131
801 - 1000	413	720	•	•	145	•	3	10	1115132
801 - 1000	413	720	389	•	145	1	3	10	1115133
1001 - 1200	513	920	539	•	244	1	4	10	1115134
1201 - 1400	563	1120	539	•	244	1	6	10	1115135
1401 - 1600	563	1320	539	•	244	1	7	10	1115136
1601 - 1800	563	1520	539	•	244	1	8	10	1115137
1601 - 1800	1000	1520	539	•	244	1	8	10	1115167
1801 - 2000	1000	1720	1209	539	977	2	11	10	1115138
2001 - 2200	1000	1920	1209	539	977	2	12	10	1115139
2201 - 2400	1000	2120	1209	539	977	2	13	10	1115140

SRH	HH	L	X	X	MS			PACK.	MATERIAL
801-1000	413	720	389	•	145	1	3	10	1142916
1001-1200	513	920	539	•	244	1	4	10	1142919
1201-1400	563	1120	539	•	244	1	6	10	1142921
1401-1600	563	1320	539	•	244	1	7	10	1142922
1601-1800	563	1520	539	•	244	1	8	10	1142923
1601-1800	1000	1520	539	•	244	1	8	10	1142924
1801-2000	1000	1720	1209	539	977	2	11	10	1142925
2001-2200	1000	1920	1209	539	977	2	12	10	1142926
2201-2400	1000	2120	1209	539	977	2	13	10	1142927

¹⁾ MISHANDLING DEVICE NOT AVAILABLE

²⁾ WITH INTEGRATED CORNER DRIVE 1 RS

³⁾ SIDE TILT - T&T

⁴⁾ BOTTOM TILT - T&Ti

⁵⁾ MUST USE SHORT CORNER DRIVE ON BOTTOM











* T&T = WITH T&T LOCK BOLT











* T&Ti = WITH CORNER DRIVE 1 RS

T&T ESPAGNOLETTE KV

Fixed handle height

Backset 7,5 mm

									
SRH	HH	L	X	X	MS			PACK.	MATERIAL
320-460 ^{1) 2) 3)}	120	320	•	•	•	•	2	10	1083104
461-600 ⁴⁾	170	410	•	•	168	•	1	10	1144252
601-800	263	520	•	•	176	•	1	10	1144253
801-1000	413	720	•	•	145	•	3	10	1144254
801-1000	413	720	389	•	145	1	3	10	1144255
1001-1200	513	920	539	•	244	1	4	10	1144256
1201-1400	563	1120	539	•	244	1	6	10	1144257
1401-1600	563	1320	539	•	244	1	7	10	1144258
1601-1800	563	1520	539	•	244	1	8	10	1144259
1801-2000	1000	1720	1209	539	977	2	11	10	1144260
2001-2200	1000	1920	1209	539	977	2	12	10	1144261
2201-2400	1000	2120	1209	539	977	2	13	10	1144262

									
SRH	HH	L	X	X	MS			PACK.	MATERIAL
801-1000	413	720	389	•	145	1	3	10	1144266
1001-1200	513	920	539	•	244	1	4	10	1144267
1201-1400	563	1120	539	•	244	1	6	10	1144268
1401-1600	563	1320	539	•	244	1	7	10	1144269
1601-1800	563	1520	539	•	244	1	8	10	1144270
1801-2000	1000	1720	1209	539	977	2	11	10	1144271
2001-2200	1000	1920	1209	539	977	2	12	10	1144272
2201-2400	1000	2120	1209	539	977	2	13	10	1144273

¹⁾ MISHANDLING DEVICE NOT AVAILABLE

²⁾ WITH INTEGRATED CORNER DRIVE 1 RS

³⁾ BOTTOM TILT - T&Ti

⁴⁾ MUST USE SHORT CORNER DRIVE ON BOTTOM

ESPAÑOLETTE

Fixed handle height

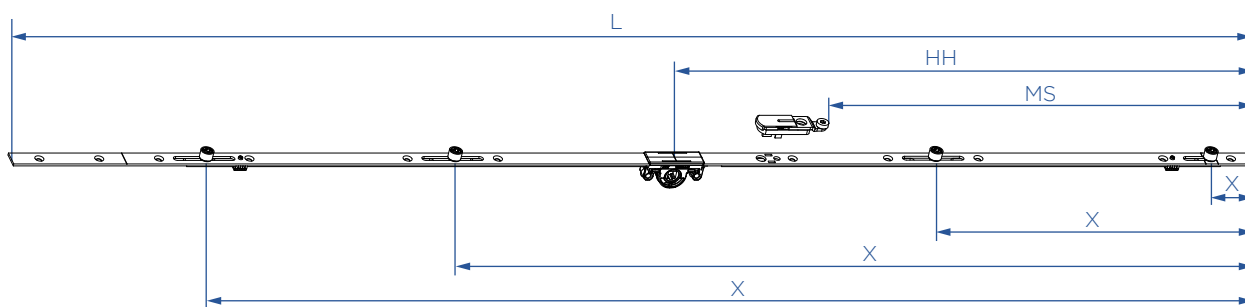

Backset 14,5 mm

SRH	HH	L	X	X	X	X	MS				PACK.	MATERIAL
400 - 500 ¹⁾	170	500	39	.	.	328	.	2	6	10	1083129	
501 - 600	170	600	39	.	.	428	219,5	2	7	10	1083130	
601 - 700	263	700	39	.	.	528	134,5	2	8	10	1083131	
701 - 800	263	800	39	.	.	628	134,5	2	9	10	1083132	
801 - 900	413	900	39	.	.	728	284,5	2	9	10	1083133	
901 - 1000	413	1000	39	.	.	828	284,5	2	9	10	1083134	
1001 - 1100	513	1100	39	.	708	928	384,5	2	10	10	1083135	
1101 - 1200	513	1200	39	.	708	1028	384,5	3	10	10	1083136	
1201 - 1300	563	1300	39	.	708	1128	384,5	3	11	10	1083137	
1301 - 1400	563	1400	39	.	708	1228	384,5	3	11	10	1083138	
1401 - 1500	563	1500	39	.	708	1328	384,5	3	11	10	1083139	
1501 - 1600	563	1600	39	.	708	1428	384,5	3	12	10	1083140	
1601 - 1700	563	1700	39	.	708	1528	384,5	3	12	10	1083141	
1701 - 1800	563	1800	39	708	1128	1628	384,5	4	14	10	1083142	
1801 - 2000	1000	2000	39	684	1278	1728	1117,5	4	15	10	1083143	
2001 - 2200	1000	2200	39	684	1328	1928	1117,5	4	15	10	1083144	
2201 - 2400	1000	2400	39	684	1528	2128	1117,5	4	17	10	1083145	

Backset 7,5 mm

SRH	HH	L	X	X	X	X	MS				PACK.	MATERIAL
400 - 500 ¹⁾	170	500	39	.	.	328	.	2	6	10	1083146	
501 - 600 ¹⁾	170	600	39	.	.	428	.	2	7	10	1083147	
601 - 700	263	700	39	.	.	528	134,5	2	8	10	1083148	
701 - 800	263	800	39	.	.	628	134,5	2	8	10	1083149	
801 - 900	413	900	39	.	.	728	284,5	2	8	10	1083150	
901 - 1000	413	1000	39	.	.	828	284,5	2	9	10	1083151	
1001 - 1100	513	1100	39	.	708	928	384,5	3	10	10	1083152	
1101 - 1200	513	1200	39	.	708	1028	384,5	3	10	10	1083153	
1201 - 1300	563	1300	39	.	708	1128	384,5	3	11	10	1083154	
1301 - 1400	563	1400	39	.	708	1228	384,5	3	11	10	1083155	
1401 - 1500	563	1500	39	.	708	1328	384,5	3	11	10	1083156	
1501 - 1600	563	1600	39	.	708	1428	384,5	3	12	10	1083157	
1601 - 1700	563	1700	39	.	708	1528	384,5	3	12	10	1083158	
1701 - 1800	563	1800	39	708	1128	1628	384,5	4	14	10	1083159	
1801 - 2000	1000	2000	39	684	1278	1728	1117,5	4	16	10	1083160	
2001 - 2200	1000	2200	39	684	1328	1928	1117,5	4	16	10	1083161	
2201 - 2400	1000	2400	39	684	1528	2128	1117,5	4	17	10	1083162	

¹⁾ MISHANDLING DEVICE NOT AVAILABLE

T&T ESPAGNOLETTE

Fixed handle height

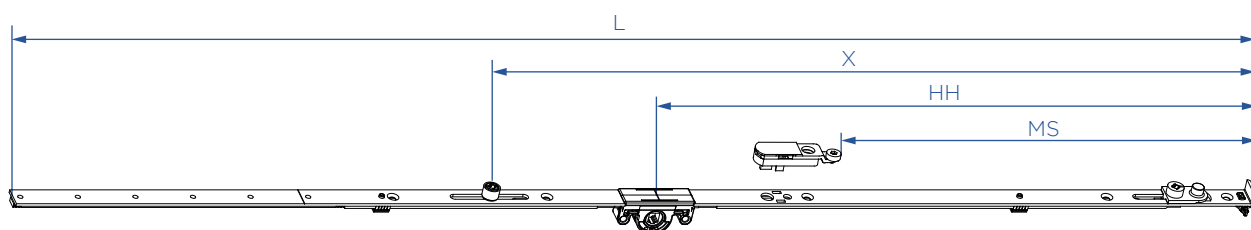

Backset 14,5 mm

SRH	HH	L	X	X	MS				PACK.	MATERIAL
320 - 460 ¹⁾	120	320	•	•	•	•	1* (0)	10	1083081	
461 - 600	170	460	•	•	219,5	•	3* (2)	10	1083082	
601 - 800	263	660	•	•	134,5	•	4* (3)	10	1083083	
801 - 1000	413	860	•	•	284,5	•	5* (4)	10	1083084	
801 - 1000	413	860	529	•	284,5	1	5* (4)	10	1083085	
1001 - 1200	513	1060	679	•	384,5	1	6* (5)	10	1083086	
1201 - 1400	563	1260	679	•	384,5	1	8* (7)	10	1083087	
1401 - 1600	563	1460	679	•	384,5	1	9* (8)	10	1083088	
1601 - 1800	563	1660	679	•	384,5	1	10* (9)	10	1083089	
1601 - 1800	1000	1660	679	•	384,5	1	10* (9)	10	1083090	
1801 - 2000	1000	1860	1349	679	1117,5	2	13* (12)	10	1083091	
2001 - 2200	1000	2060	1349	679	1117,5	2	14* (13)	10	1083092	
2201 - 2400	1000	2260	1349	679	1117,5	2	15* (14)	10	1083093	

SRH	HH	L	X	X	X	MS			PACK.	MATERIAL
1201 - 1400	563	1260	910	679	•	384,5	2	9* (8)	10	1093878
1401 - 1600	563	1460	1110	679	•	384,5	2	10* (9)	10	1093877
1601 - 1800	563	1660	1110	679	•	384,5	2	11* (10)	10	1093874
1801 - 2000	1000	1860	•	1349	679	1117,5	2	12* (11)	10	1083091
2001 - 2200	1000	2060	1710	1349	679	1117,5	3	13* (12)	10	1093873
2201 - 2400	1000	2260	1710	1349	679	1117,5	3	14* (13)	10	1093872











SRH	HH	L	X	X	MS				PACK.	MATERIAL
801 - 1000	413	860	529	•	284,5	1	5* (4)	10	1101026	
1001 - 1200	513	1060	679	•	384,5	1	6* (5)	10	1101027	
1201 - 1400	563	1260	679	•	384,5	1	8* (7)	10	1101028	
1401 - 1600	563	1460	679	•	384,5	1	9* (8)	10	1101029	
1601 - 1800	563	1660	679	•	384,5	1	10* (9)	10	1101030	
1601 - 1800	1000	1660	679	•	384,5	1	10* (9)	10	1101031	
1801 - 2000	1000	1860	1349	679	1117,5	2	13* (12)	10	1101032	
2001 - 2200	1000	2060	1349	679	1117,5	2	14* (13)	10	1101033	
2201 - 2400	1000	2260	1349	679	1117,5	2	15* (14)	10	1101034	

¹⁾ MISHANDLING DEVICE NOT AVAILABLE

* WITHOUT THE USE OF CENTER LOCK

(X) WITH THE USE OF CENTER LOCK

Backset 7,5 mm

 SRH	 HH	 L	 X	 X	 MS			 PACK.	 MATERIAL
330 - 460 ¹⁾²⁾	120	320	•	•	•	•	1* (0)	10	1083104
461 - 600 ²⁾	170	460	•	•	•	•	3* (2)	10	1083105
601 - 800	263	660	•	•	134,5	•	4* (3)	10	1083106
801 - 1000	413	860	•	•	284,5	•	5* (4)	10	1083107
801 - 1000	413	860	529	•	284,5	1	5* (4)	10	1083108
1001 - 1200	513	1060	679	•	384,5	1	6* (5)	10	1083109
1201 - 1400	563	1260	679	•	384,5	1	8* (7)	10	1083110
1401 - 1600	563	1460	679	•	384,5	1	9* (8)	10	1083111
1601 - 1800	563	1660	679	•	384,5	1	10* (9)	10	1083112
1601 - 1800	1000	1660	679	•	384,5	1	10* (9)	10	1083113
1801 - 2000	1000	1860	1349	679	1117,5	2	13* (12)	10	1083114
2001 - 2200	1000	2060	1349	679	1117,5	2	14* (13)	10	1083115
2201 - 2400	1000	2260	1349	679	1117,5	2	15* (14)	10	1083116

¹⁾ WITH INTEGRATED CORNER DRIVE 1 RS

²⁾ MISHANDLING DEVICE NOT AVAILABLE

* WITHOUT THE USE OF CENTER LOCK

(X) WITH THE USE OF CENTER LOCK

REVERSE ACTION ESPAGNOLETTE

Fixed handle height

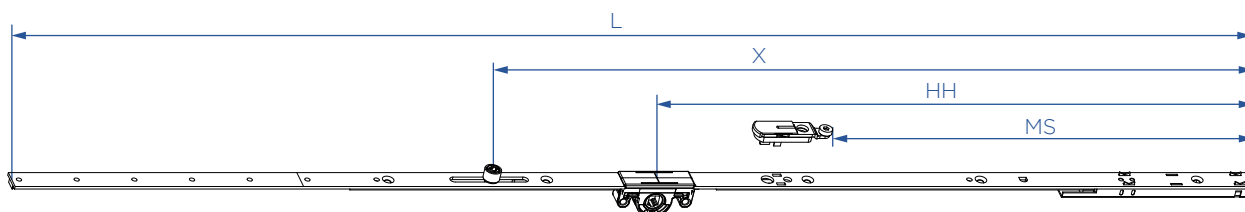

Backset 14,5 mm

SRH	HH	L	X	X	MS			PACK.	MATERIAL
440 - 600	170	460	2	10	1105363
601 - 800	263	660	.	.	134,5	.	4	10	1105364
801 - 1000	413	860	529	.	284,5	1	5	10	1105365
1001 - 1200	513	1060	679	.	384,5	1	6	10	1105366
1201 - 1400	563	1260	679	.	384,5	1	8	10	1105367
1401 - 1600	563	1460	679	.	384,5	1	8	10	1105368
1601 - 1800	563	1660	679	1349	384,5	2	10	10	1105369
1801 - 2000	1000	1860	679	1349	384,5	2	12	10	1105370
2001 - 2200	1000	2060	679	1349	384,5	2	13	10	1105371
2201 - 2400	1000	2260	679	1349	384,5	2	14	10	1105372

FRENCH WINDOW ESPAGNOLETTE M

Centered / variable handle height

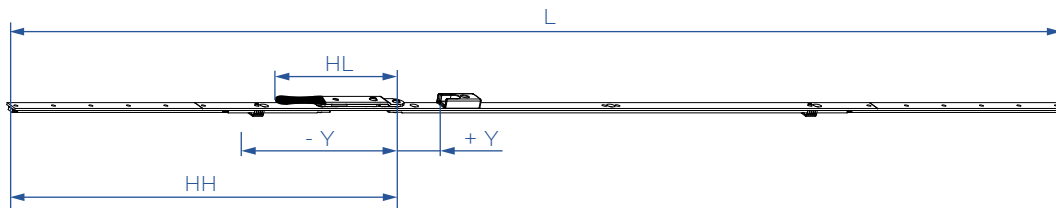

SRH	HH	L	Y ³⁾	Y	Y	Y ³⁾	HL	PACK.	BACKSET ²⁾	MATERIAL	
500 - 680 ¹⁾	290-380	400	•	•	•	•	2	130	10	14,5	1098116
600 - 1000 ¹⁾	387-586	720	•	- 189,5	•	•	3	130	10	14,5	1098120
800 - 1000 ¹⁾	587-686	720	•	- 289,5	•	•	3	130	10	7,5	1098121
900 - 1400	350-550	1120	•	+ 61,5	•	•	4	130	10	14,5/7,5	1098122
900 - 1400	350-550	1120	•	- 178,5	+ 241,5	•	4	130	10	14,5	1099308
1401 - 1800*	350-550	1520	+ 161,5	+ 261,5	•	+ 581,5	6	130	10	14,5/7,5	1098123
1601 - 2000*	350-550	1720	+ 581,5	+ 161,5	+ 781,5	+ 1031,5	8	130	10	14,5/7,5	1098124
2001 - 2400*	350-550	2120	+ 41,5	+ 361,5	+ 981,5	+ 1301,5	10	130	10	14,5/7,5	1098125

¹⁾ MISHANDLING DEVICE NOT AVAILABLE

²⁾ T&T ESPAGNOLETTE M BACKSET COMPATIBLE

³⁾ FOR ADDITIONAL LOCKING CAM - INSTALL STRIKER 1100213

* FR. WIN. ESPAGNOLETTE BULLET CATCH POSSIBLE

FRENCH WINDOW ESPAGNOLETTE KV

Fixed handle height

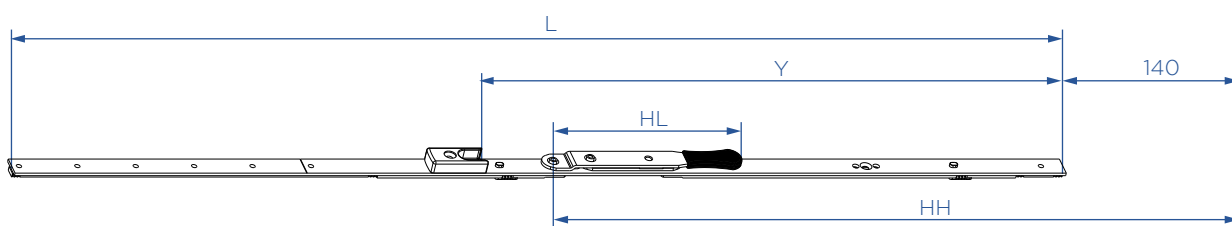

SRH	HH	L	Y	Y		HL	PACK.	MATERIAL
460 - 600 ¹⁾²⁾	230	410	.	.	2	130	10	1118420
601 - 800 ²⁾	335	520	.	.	2	130	10	1118421
801 - 1000	490	720	397,5	.	3	130	10	1118423
1001 - 1200	335	920	547,5	.	4	130	10	1118424
1201 - 1400	335	1120	547,5	.	6	130	10	1118425
1401 - 1600	335	1320	547,5	.	7	130	10	1118426
1601 - 1800*	335	1520	547,5	.	8	130	10	1118427
1801 - 2000*	640	1720	547,5	1217,5	11	130	10	1118428
2001 - 2200*	640	1920	547,5	1217,5	12	130	10	1118429
2201 - 2400*	640	2120	547,5	1217,5	13	130	10	1118430

¹⁾ MUST USE SHORT CORNER DRIVE ON BOTTOM

²⁾ MISHANDLING DEVICE NOT AVAILABLE

* FR. WIN. ESPAGNOLETTE BULLET CATCH POSSIBLE

FRENCH WINDOW ESPAGNOLETTE T&T

Fixed handle height

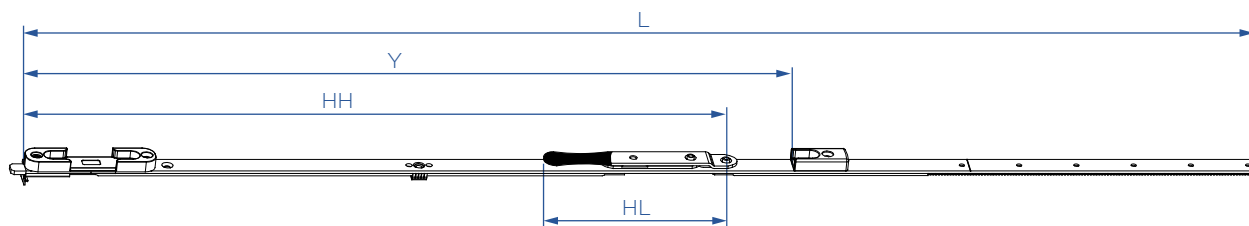

SRH	HH	L	Y	Y		PACK.	MATERIAL
600 - 800 ¹⁾	335	660	•	•	4*(3)	10	1083174
801 - 1000	490	860	536,5	•	4*(3)	10	1083175
1001 - 1200	335	1060	687,5	•	5*(4)	10	1083176
1201 - 1400	335	1260	687,5	•	8*(7)	10	1083177
1401 - 1600	335	1460	687,5	•	8*(7)	10	1083178
1601 - 1800*	335	1660	687,5	•	9*(8)	10	1083179
1801 - 2000*	640	1860	687,5	1357,5	10*(9)	10	1083180
2001 - 2200*	640	2060	687,5	1357,5	11*(10)	10	1083181
2201 - 2400*	640	2260	687,5	1357,5	12*(11)	10	1083182

¹⁾ MISHANDLING DEVICE NOT AVAILABLE

* WITHOUT THE USE OF CENTER LOCK







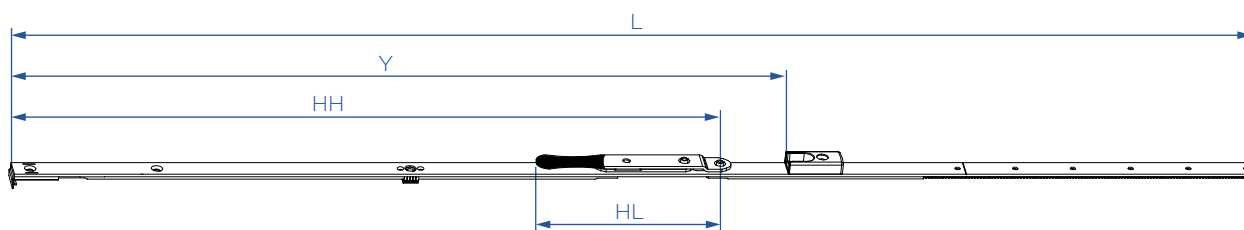

(X) WITH THE USE OF CENTER LOCK

* FR. WIN. ESPAGNOLETTE BULLET CATCH POSSIBLE

FRENCH WINDOW ESPAGNOLETTE T&TI

Fixed handle height



 SRH	 HH	 L	 Y	 Y		 PACK.	 MATERIAL
600 - 800 ¹⁾	335	660	.	.	4*(3)	10	1105752
801 - 1000	490	860	536,5	.	4*(3)	10	1105754
1001 - 1200	335	1060	687,5	.	5*(4)	10	1105755
1201 - 1400	335	1260	687,5	.	8*(7)	10	1105756
1401 - 1600	335	1460	687,5	.	8*(7)	10	1105757
1601 - 1800*	335	1660	687,5	.	9*(8)	10	1105758
1801 - 2000*	640	1860	687,5	1357,5	10*(9)	10	1105759
2001 - 2200*	640	2060	687,5	1357,5	11*(10)	10	1105760
2201 - 2400*	640	2260	687,5	1357,5	12*(11)	10	1105761

¹⁾ MISHANDLING DEVICE NOT AVAILABLE

* WITHOUT THE USE OF CENTER LOCK

(X) WITH THE USE OF CENTER LOCK

* FR. WIN. ESPAGNOLETTE BULLET CATCH POSSIBLE

CORNER DRIVE

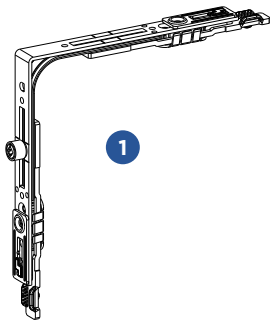

1

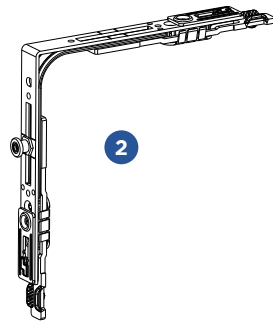

2

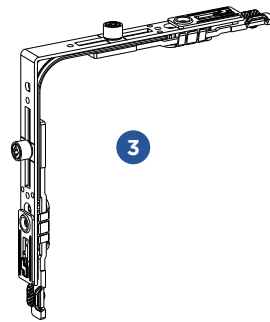

3

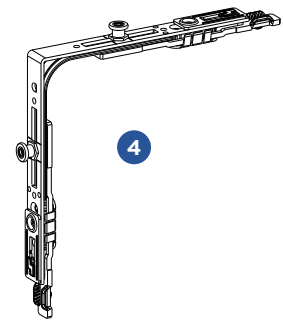

4

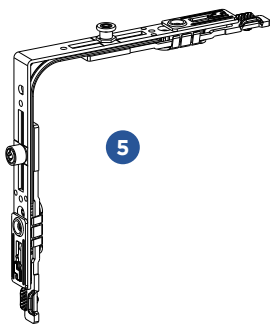

5

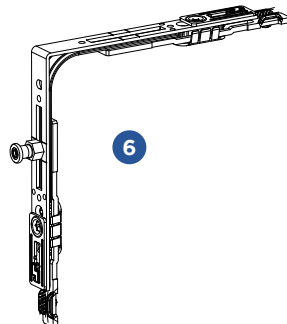

6

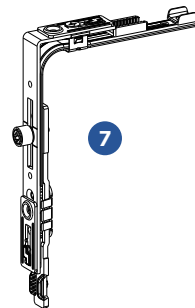

7

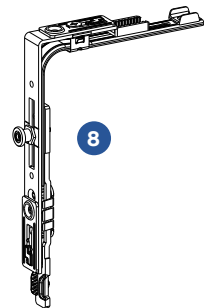

8



9

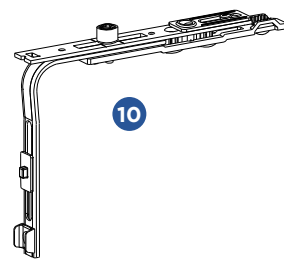

10

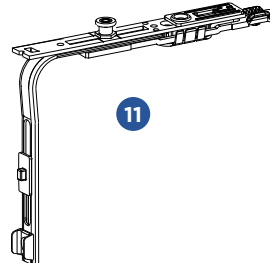

11

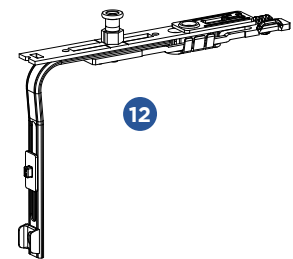

12

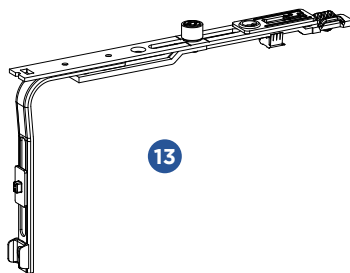

13

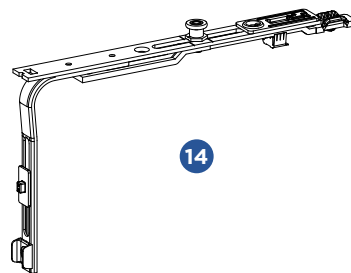

14

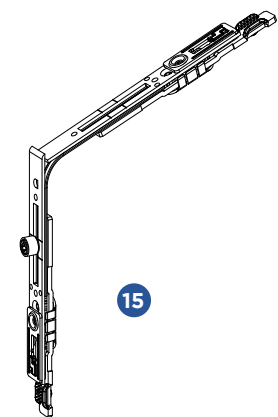

15



15

CORNER DRIVE



TYPE	DESCRIPTION	CAM				PACK.	MATERIAL
1	Corner drive	1 R	1	•	4	10	1103158
2	Corner drive	1 RS	1	•	4	10	1100983
3	Corner drive	2 R	2	•	4	10	1103159
4	Corner drive	2 RS	2	•	4	10	1100984
5	Corner drive	1 R + 1 RS	2	•	4	10	1100985
6*	Corner drive	1 RS LONG	1	•	4	10	1113170
7	Short corner drive	1 R	1	•	3	10	1103162
8	Short corner drive	1 RS	1	•	3	10	1100986
9	Short corner drive	Shootbolt	1	•	3	10	1103161
10	Corner lock 140	1 R	1	•	2	10	1103166
11	T&Ti Corner lock 140 - SECURITY	1 RS	1	•	2	10	1100988
12*	T&Ti Corner lock 140 - SECURITY	1 RS LONG	1	•	2	10	1113402
13	Corner lock 180	1 R	1	•	2	10	1103164
14	T&Ti Corner lock 180 - SECURITY	1 RS	1	•	2	10	1100987
15	Movement restrictor 90° for corner drive	•	•	•	1	100	1142599

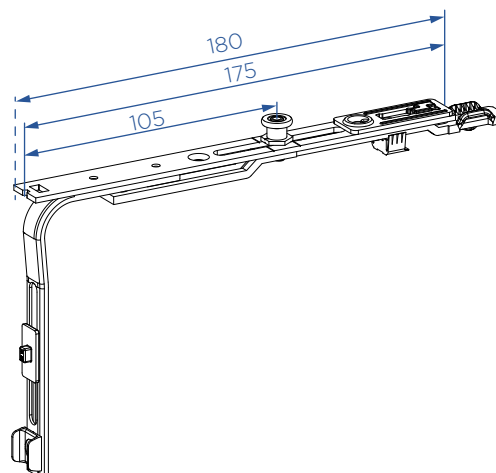
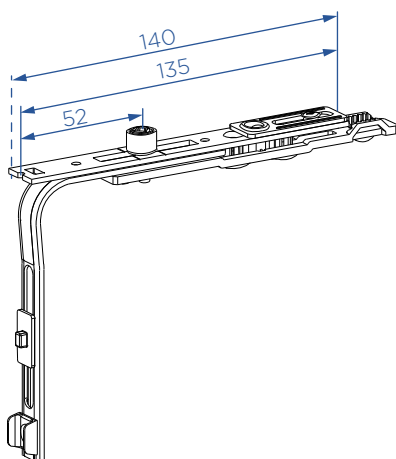
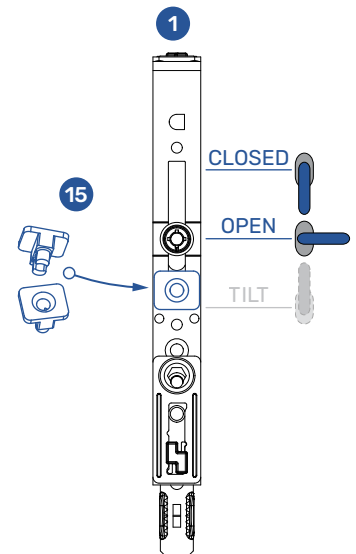
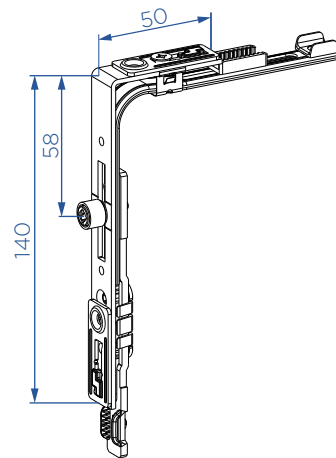
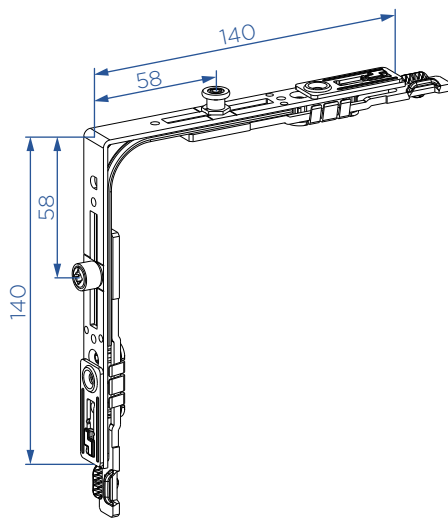





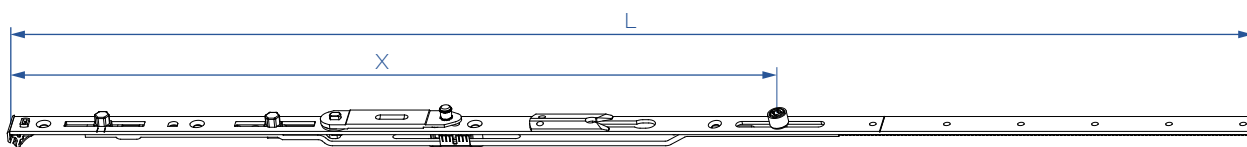



* FOR LOW THRESHOLD - USE IN COMBINATION WITH T&TI STRIKER 1116153

SASH-STAY GUIDE







Turn & tilt

SRW	L	X				
SRW	L	X			PACK.	MATERIAL
250 - 430 ¹⁾	150 / 290	•	•	2* (1)	10	1123308
411 - 610	250 / 470	•	•	3* (2)	10	1083038
611 - 810	350 / 670	•	•	5* (4)	10	1083039
811 - 1010	500 / 870	547	1	6* (5)	10	1083040
1011 - 1210	500 / 1070	608	1	8* (7)	10	1083041
1211 - 1400	500 / 1270	808	1	9* (8)	10	1083042

SRW	L	X				
SRW	L	X			PACK.	MATERIAL
811 - 1010	500 / 870	547	1	6* (5)	10	1100978
1011 - 1210	500 / 1070	608	1	8* (7)	10	1100980
1211 - 1410	500 / 1270	808	1	9* (8)	10	1100981

Turn only - SECOND SASH

SRW	L	X				
SRW	L	X			PACK.	MATERIAL
410 - 610	250 / 470	•	•	3* (2)	10	1105855
611 - 810	350 / 670	•	•	5* (4)	10	1105856
811 - 1010	500 / 870	547	1	6* (5)	10	1105857
1011 - 1211	350 / 670+400	547	2	8* (7)	10	1105856 + 1102897
1211 - 1400	500 / 870+400	547	2	9* (8)	10	1105857 + 1102897

¹⁾ SRW = 250 - 340 mm, WITH SHORT CORNER DRIVE

* WITHOUT THE USE OF CENTER LOCK

(X) WITH THE USE OF CENTER LOCK

* SRH < 500 mm, move the anti-slam device to reduce the tilt

SASH-STAY GUIDE

Sash stay guide - additional security

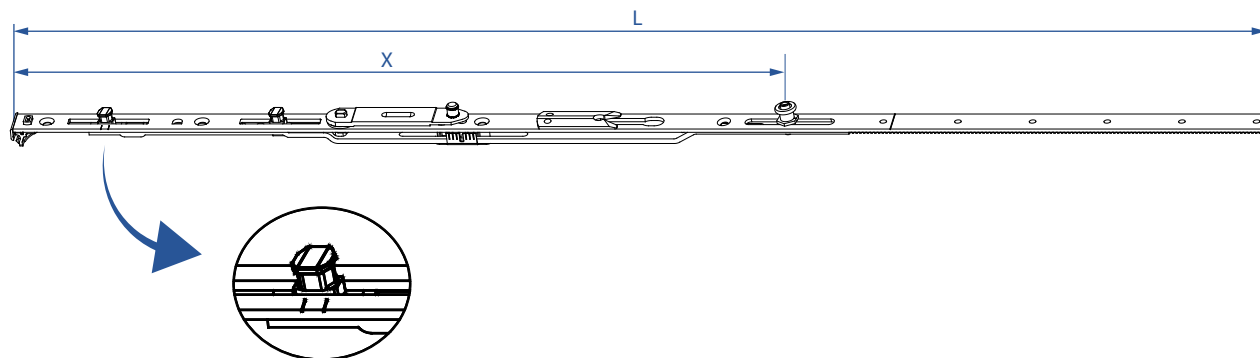

SRW	L	X	RS			PACK.	MATERIAL
250-430 ¹⁾	150 / 290	•	•	2* (1)	10	1144882	
411-610	250 / 470	•	•	3* (2)	10	1144883	
611-810	350 / 670	•	•	5* (4)	10	1144884	
811-1010	500 / 870	547	1	6* (5)	10	1144885	
1011-1210	500 / 1070	608	1	8* (7)	10	1144886	
1211-1400	500 / 1270	808	1	9* (8)	10	1144887	

¹⁾ SRW = 250 - 340 mm, WITH SHORT CORNER DRIVE

* WITHOUT THE USE OF CENTER LOCK

(X) WITH THE USE OF CENTER LOCK

Stay arm

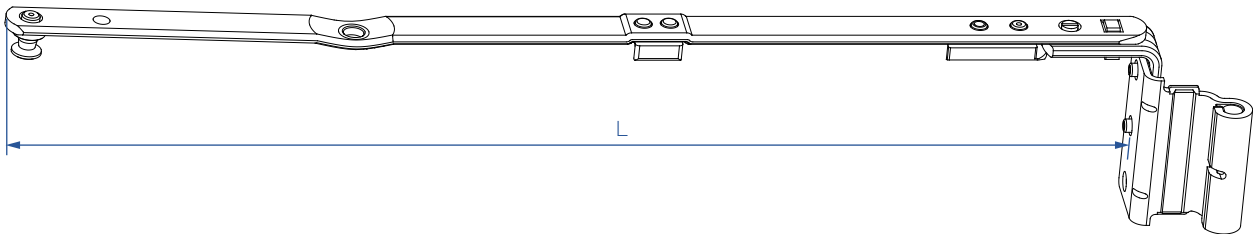

SYSTEM	SRW	L	POSITION	PACK.	MATERIAL
12/18-9	250 - 430 ¹⁾	150	L	10	1134891
	250 - 430 ¹⁾	150	R	10	1134892
	410 - 610	250	L	10	1104742
	410 - 610	250	R	10	1104743
	611 - 810	350	L	10	1104744
	611 - 810	350	R	10	1104745
	811 - 1400	500	L	10	1104746
	811 - 1400	500	R	10	1104747
12/20-9	250 - 430 ¹⁾	150	L	10	1131552
	250 - 430 ¹⁾	150	R	10	1131553
	410 - 610	250	L	10	1083008
	410 - 610	250	R	10	1083009
	611 - 810	350	L	10	1083010
	611 - 810	350	R	10	1083011
	811 - 1400	500	L	10	1083012
	811 - 1400	500	R	10	1083013
12/18-13	250 - 430 ¹⁾	150	L	10	1140315
	250 - 430 ¹⁾	150	R	10	1140317
	410 - 610	250	L	10	1104753
	410 - 610	250	R	10	1104755
	611 - 810	350	L	10	1104756
	611 - 810	350	R	10	1104757
	811 - 1400	500	L	10	1104758
	811 - 1400	500	R	10	1104759
12/20-13	250 - 430 ¹⁾	150	L	10	1123306
	250 - 430 ¹⁾	150	R	10	1123307
	410 - 610	250	L	10	1083016
	410 - 610	250	R	10	1083017
	611 - 810	350	L	10	1083018
	611 - 810	350	R	10	1083019
	811 - 1400	500	L	10	1083020
	811 - 1400	500	R	10	1083021

¹⁾ SRW = 250 - 340 mm, WITH SHORT CORNER DRIVE AND SASH STAY GUIDE 150 / 290

STAY ARM

Stay arm - additional security

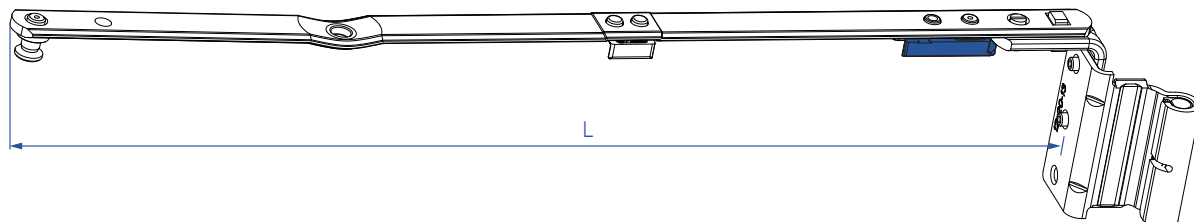

SYSTEM	SRW	L	POSITION	PACK.	MATERIAL
12/20-13	250-430 ¹⁾	150	L	10	1144380
	250-430 ¹⁾	150	R	10	1144381
	410-610	250	L	10	1144382
	410-610	250	R	10	1144383
	611-810	350	L	10	1144384
	611-810	350	R	10	1144385
	811-1400	500	L	10	1144386
	811-1400	500	R	10	1144387

¹⁾ SRW = 250 - 340 mm, WITH SHORT CORNER DRIVE
AND SASH STAY GUIDE 150/190

STAY ARM

Rebate stay arm

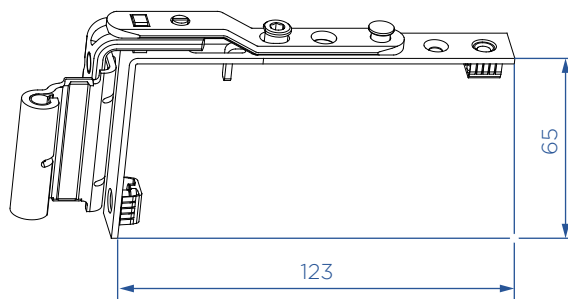

SYSTEM	POSITION		PACK.	MATERIAL
12/18-9	L	5	40	1104763
	R	5	40	1104764
12/20-9	L	5	40	1083265
	R	5	40	1083264
12/18-13	L	5	40	1104765
	R	5	40	1104766
12/20-13	L	5	40	1083263
	R	5	40	1083262

Rebate stay arm - ALU

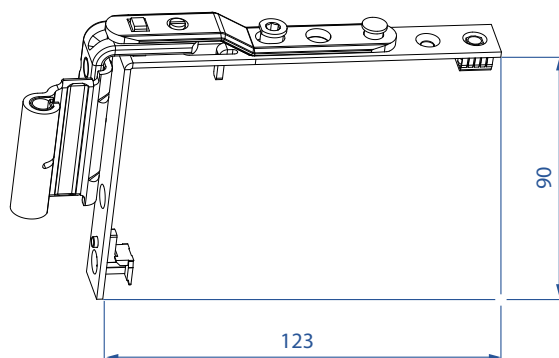

12/20-9		4	40	1146161
		4	40	1146162

STAY ARM

Tilt stay

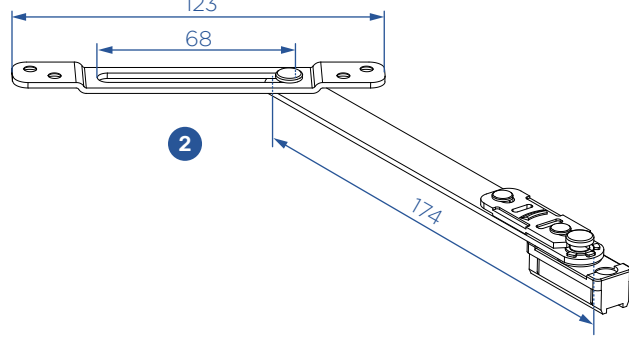
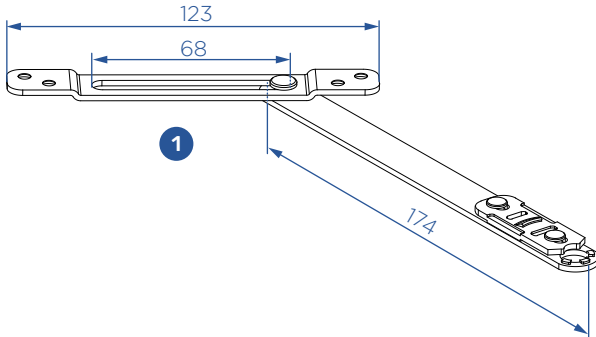

TYPE	DESCRIPTION			
			PACK.	MATERIAL
1	TILT STAY for espagnolette / center lock	5	100	1099152
2	TILT STAY for groove	7	100	1099154

CENTER LOCK

With guide

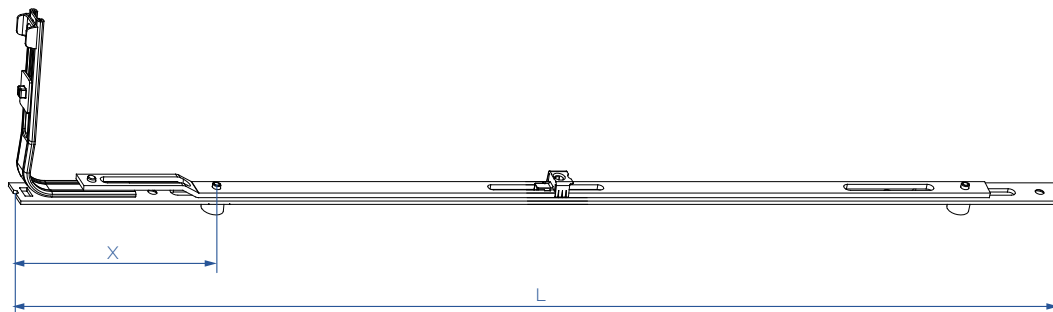







SRH	SRW	L	(R)	(R)	(R)	(R)			PACK.	MATERIAL
600 - 800	600 - 800	350	299	•	•	•	1	4	10	1093871
801 - 1200	801 - 1200	550	105	499	•	•	2	4	10	1083058
1201 - 1600	1201 - 1400	850	105	799	•	•	2	6	10	1083059
1601 - 2200	•	1550	105	799	1499	•	3	10	10	1083060
2201 - 2400	•	2000	105	799	1499	1949	4	11	10	1083064

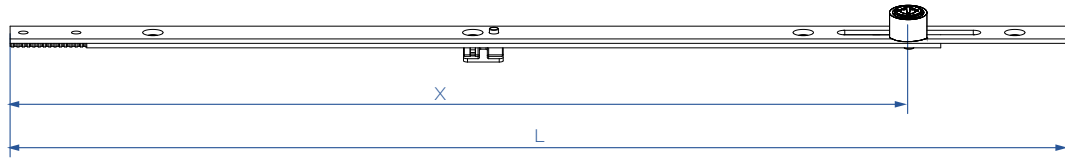





SRH	SRW	L	(RS)	(RS)	(RS)	(RS)			PACK.	MATERIAL
801 - 1200	801 - 1200	550	105	499	•	•	2	4	10	1101000
1201 - 1600	1201 - 1400	850	105	799	•	•	2	6	10	1101002
1601 - 2200	•	1550	105	799	1499	•	3	10	10	1101003
2201 - 2400	•	2000	105	799	1499	1949	4	11	10	1101004

CENTER LOCK

Without guide



						
DESCRIPTION	L	X			PACK.	MATERIAL
400	400	339	1	4	10	1083061
600	600	539	1	4	10	1083062
600 coupling	600	539	1	4	10	1102900

						
DESCRIPTION	L	X			PACK.	MATERIAL
200	200	139	1	2	10	1101005
400	400	339	1	4	10	1101006
400*	400	339	1	4	10	1121626
600	600	539	1	4	10	1101012
200 coupling	200	139	1	2	10	1101015
400 coupling	400	339	1	4	10	1101016
600 coupling	600	539	1	4	10	1101017

* FOR LOW THRESHOLD - USE IN COMBINATION WITH T&TI STRIKER 1116153

ESPAGNOLETTE EXTENSION

Lock bolt

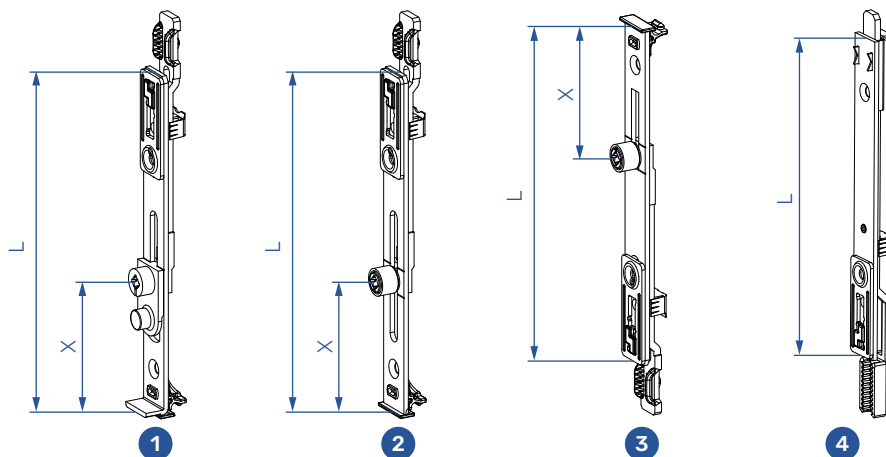

TYPE	DESCRIPTION	L			X		PACK.	MATERIAL
1	TILT LOCK BOLT < 1000	140	1	•	•	3* (2)	100	1102388
	TILT LOCK BOLT > 1001	140	1	•	•	3* (2)	100	1102391
2	TILT LOCK BOLT 140	140	•	1	53,5	3* (2)	100	1102394
3	TILT LOCK BOLT 140/90	140	•	1	53,5	3* (2)	100	1102395
4	EXT.FR.WIN.ESPAGNO. - 11 - TOP	140	•	•	•	3* (2)	50	1103211

* WITHOUT THE USE OF CENTER LOCK
(X) WITH THE USE OF CENTER LOCK

French window lock bolt

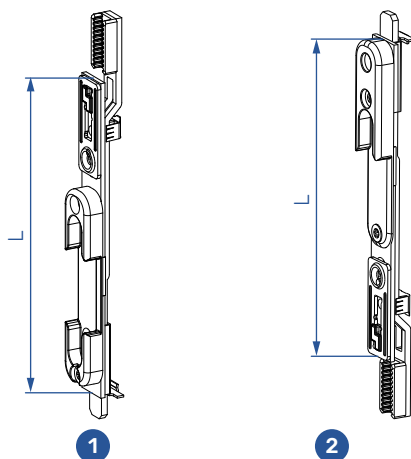

TYPE	DESCRIPTION	L			PACK.	MATERIAL
1	T&T EXT. FR. WIN. ESPAGNOLETTE M - 11 mm	140			3* (2)	1102621
2	EXT. FR. WIN. ESPAGNOLETTE - 11 mm - TOP	140			3* (2)	1110929







* WITHOUT THE USE OF CENTER LOCK
(X) WITH THE USE OF CENTER LOCK

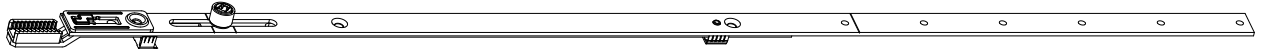





* dimensions in table are given for a stretched / straight center lock (before bending)

ESPAGNOLETTE EXTENSION

Primary window







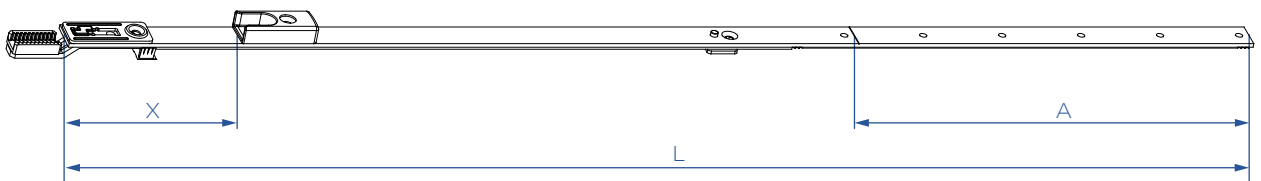

							
DESCRIPTION	A	L	X			PACK.	MATERIAL
400	200	400	79	1	3	10	1102897
600	200	600	79	1	4	10	1102898
800	200	800	79	1	5	10	1102899

							
DESCRIPTION	A	L	X			PACK.	MATERIAL
400	200	400	79	1	3	10	1137685
600	200	600	79	1	4	10	1140952
800	200	800	79	1	5	10	1144538

French window



							
DESCRIPTION	A	L	X			PACK.	MATERIAL
400	200	400	87,5	1	3	10	1105373
600	200	600	87,5	1	4	10	1105374

SHOOTBOLT

OHG

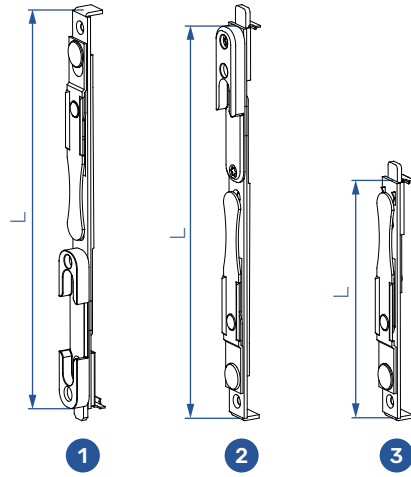

TYPE	DESCRIPTION	L		PACK.	MATERIAL
1	T&T SHOOTBOLT - BOTTOM	230	3* (2)	50	1083252
2	SHOOTBOLT with STRIKER - TOP	230	3* (2)	50	1083253
3	SHOOTBOLT without STRIKER - TOP	140	2	100	1083254

* WITHOUT THE USE OF CENTER LOCK

(X) WITH THE USE OF CENTER LOCK

HINGE SIDE

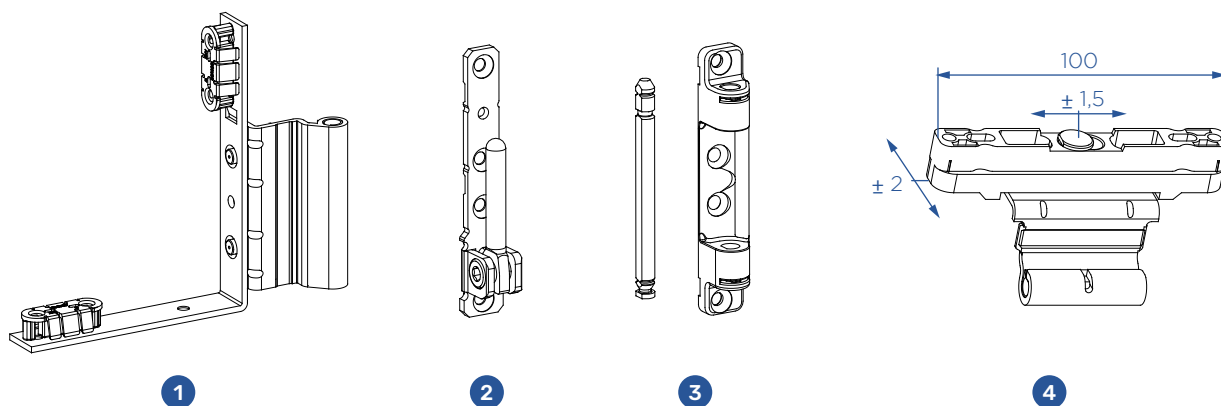

TYPE	DESCRIPTION	POS.	PACK.	MATERIAL	
1	CORNER HINGE 12/18-9	L	8	40	1101236
		R	8	40	1101237
	CORNER HINGE 12/20-9	L	8	40	1101239
		R	8	40	1101241
	CORNER HINGE 12/18-13	L	8	40	1101242
		R	8	40	1101243
CORNER HINGE 12/20-13	L	8	40	1101244	
	R	8	40	1101245	

TYPE	DESCRIPTION	POS.	PACK.	MATERIAL	
2	CORNER PIVOT REST K3	L/R	4	200	1083247

TYPE	DESCRIPTION	POS.	PACK.	MATERIAL	
3	STAY BEARING WITH PIN K3	L / R	4	200	1083250

TYPE	DESCRIPTION	PACK.	MATERIAL	
4	REBATE CENTER HINGE 12/18-9 - adjustable	4	50	1104760
	REBATE CENTER HINGE 12/20-9 - adjustable	4	50	1083269
	REBATE CENTER HINGE 12/18-13 - adjustable	4	50	1104762
	REBATE CENTER HINGE 12/20-13 - adjustable	4	50	1083268

NUMBER OF REBATE CENTER HINGES ACCORDING TO SASH REBATE WIDTH

TILT WINDOW - SRW	NUMBER OF HINGES
< 1200	2
1201 - 2200	3
2201 - 2400	4

COVER CAPS

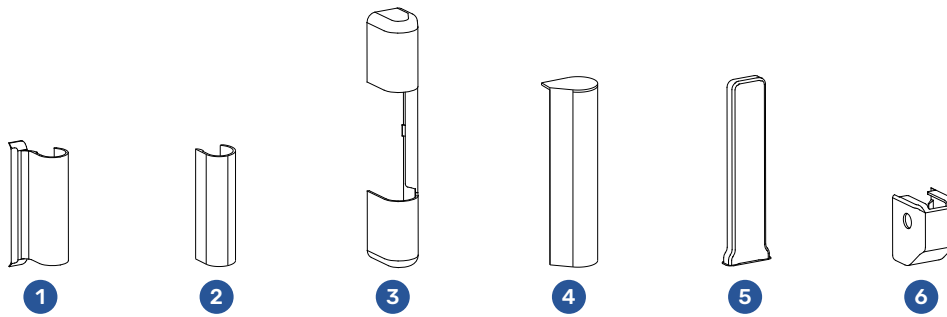

TYPE	DESCRIPTION	RAL	POS.	PACK.	MATERIAL
1	COVER CAP STAY ARM	RAL9016 - White		400	1127415
		RAL8019 - Greybrown		400	1127416
		RAL9005 - Black		400	1127417
		RAL9001 - Cream White		400	1127418
		RAL7016 - Anthracite grey		400	1134364
		SILVER		400	1127425
		DARK BRONZE		400	1127424
		TITANmat		400	1127423
		GOLDshine		400	1127426
		GOLDmat		400	1135425
2	COVER CAP STAY ARM 2	RAL9016 - White		500	1127419
		RAL8019 - Greybrown		500	1127420
		RAL9005 - Black		500	1127421
		RAL9001 - Cream White		500	1127422
		RAL7016 - Anthracite grey		500	1141060
		SILVER		500	1127430
		DARK BRONZE		500	1127428
		TITANmat		500	1127429
		GOLDshine		500	1127427
		GOLDmat		500	1141059
3	COVER CAP STAY BEARING	RAL9016 - White		100	1127402
		RAL8019 - Greybrown		100	1127403
		RAL9005 - Black		100	1127404
		RAL9001 - Cream White		100	1127405
		RAL7016 - Anthracite grey		100	1134361
		SILVER		100	1127412
		DARK BRONZE		100	1127410
		TITANmat		100	1127411
		GOLDshine		100	1127409
		GOLDmat		100	1135423

COVER CAPS

	RAL9016 - White	L	200	1127493
		R	200	1127498
	RAL8019 - Greybrown	L	200	1127494
		R	200	1127499
	RAL9005 - Black	L	200	1127495
		R	200	1127500
	RAL9001 - Cream White	L	200	1127497
		R	200	1127502
	RAL7016 - Anthracite grey	L	200	1134365
		R	200	1134366
4	COVER CAP REBATE CORNER HINGE	L	200	1127496
	SILVER	R	200	1127501
	DARK BRONZE	L	200	1127505
		R	200	1127506
	TITANmat	L	200	1127504
		R	200	1127508
	GOLDshine	L	200	1127503
		R	200	1127507
	GOLDmat	L	200	1135426
		R	200	1135427
	RAL9016 - White		500	1127390
	RAL8019 - Greybrown		500	1127391
	RAL9005 - Black		500	1127392
	RAL9001 - Cream White		500	1127393
	RAL7016 - Anthracite grey		500	1134359
5	COVER CAP CORNER PIVOT REST - flat		500	1127400
	SILVER		500	1127398
	DARK BRONZE		500	1127399
	TITANmat		500	1127401
	GOLDshine		500	1135422
	GOLDmat		500	1127386
	RAL9016 - White		300	1127387
	RAL8019 - Greybrown		300	1127388
	RAL9005 - Black		300	1127389
	RAL9001 - Cream White		300	1134358
	RAL7016 - Anthracite grey		300	1127394
6	COVER CAP CORNER PIVOT REST		300	1127395
	SILVER		300	1127397
	DARK BRONZE		300	1127396
	TITANmat		300	1135421
	GOLDshine		300	
	GOLDmat		300	

* COVER CAPS "RAL" ARE INJECTED

* COVER CAPS "COLOR" ARE COLORED

FRAME PARTS

Striker

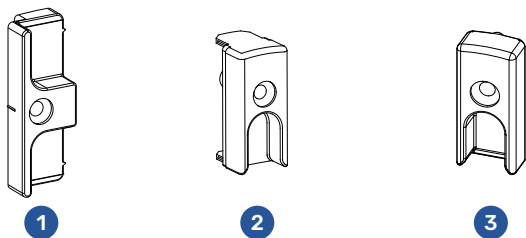

TYPE	AXIS	PACK.	MATERIAL
1	9	300	1097952
	13	300	1105495
2	OHG	300	1083207
3	ESPAG.	300	1100213

T&T striker

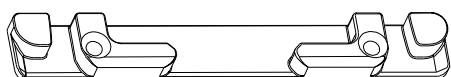

AXIS	PACK.	MATERIAL
9	250	1097951
13	250	1105496

T&Ti striker

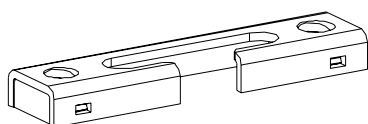

AXIS	POS.	PACK.	MATERIAL
9	L	100	1111000
	R	100	1110999
13	L	100	1110998
	R	100	1110997

Security striker

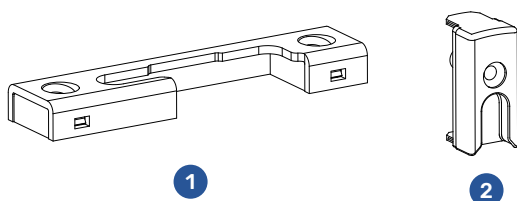

TYPE	AXIS	POS.	PACK.	MATERIAL
1	9	L	250	1111125
		R	250	1111124
	13	L	250	1111123
		R	250	1111122
2	OHG	L / R	300	1066042

FRAME PARTS

Striker - second sash

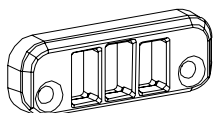

AXIS	PACK.	MATERIAL
9	300	1097953
13	300	1105499

Mishandling device

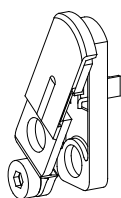

1

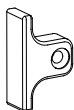

2

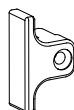

3

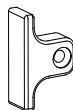

4

TYPE	AXIS	PACK.	MATERIAL
1	SASH	300	1093907
2	9	300	1098127
3	13	300	1105500
4*	OHG	300	1083293
	OHG ESPAG.	300	1083295

* FOR FR. WIN. ESPAGNOLETTE SRH > 1600 mm

Concealed center striker

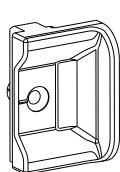

1

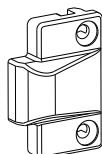

2

TYPE	AXIS	PACK.	MATERIAL
1	SASH	300	1127509
2	9	500	1127511
	13	500	1128331

NUMBER OF CONCEALED CENTER STRIKERS ACCORDING TO SASH REBATE HEIGHT

SRH	NR. OF STRIKERS
800 - 1400	1
1401 - 2000	2
2001 - 2400	3



Installation instructions

Profile treatment, hardware mounting, hardware maintenance
Detailed information

Window-handle drilling

GEAR-CASE SPROCKET AND LUGS' DRILL HOLE

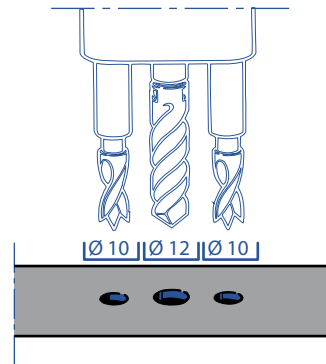
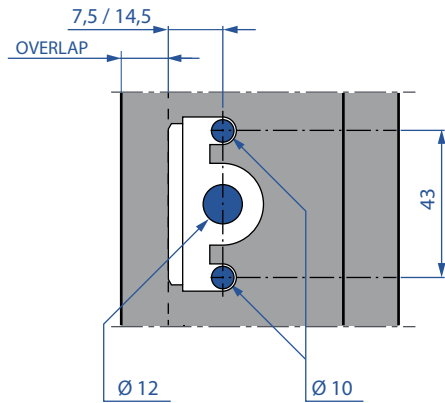

Gear-case routing

ESPAGNOLETTE GEAR-CASING

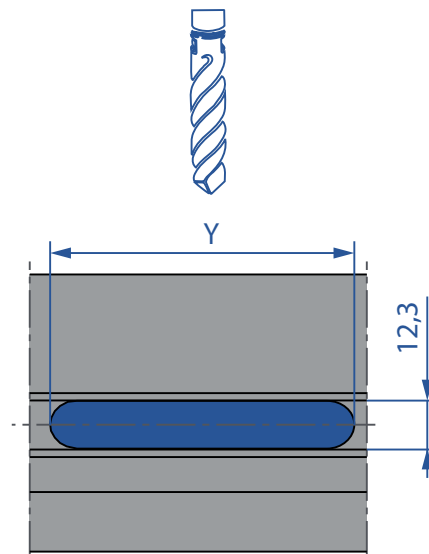
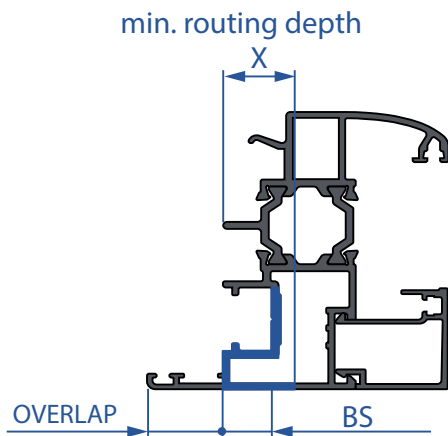

BS	X
7,5	20
14,5	27

BS	Y
7,5	34
14,5	64

Lock-case drilling

ESPAÑOLETE LOCK-CASING

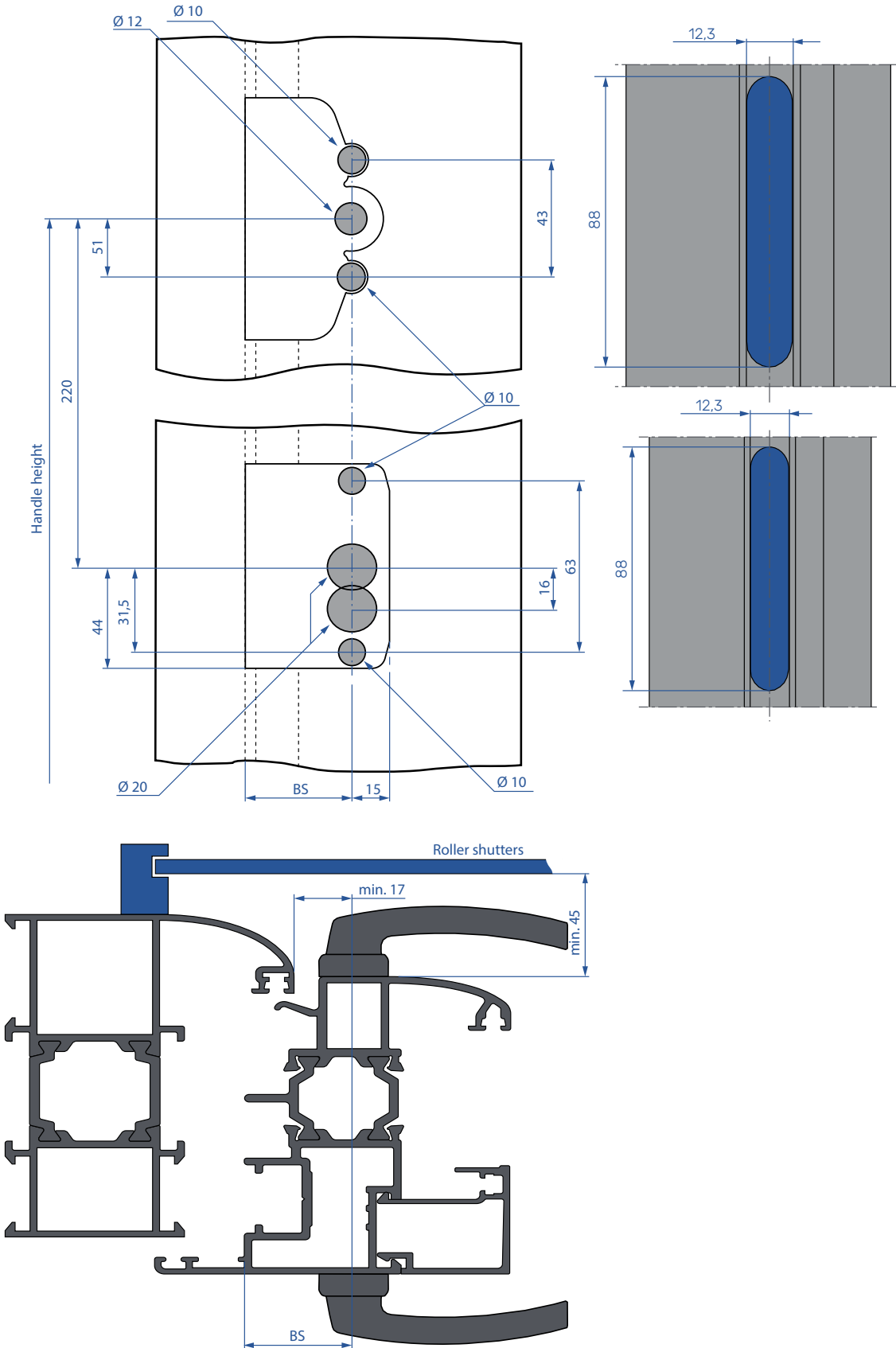

Sash stay bearing K3

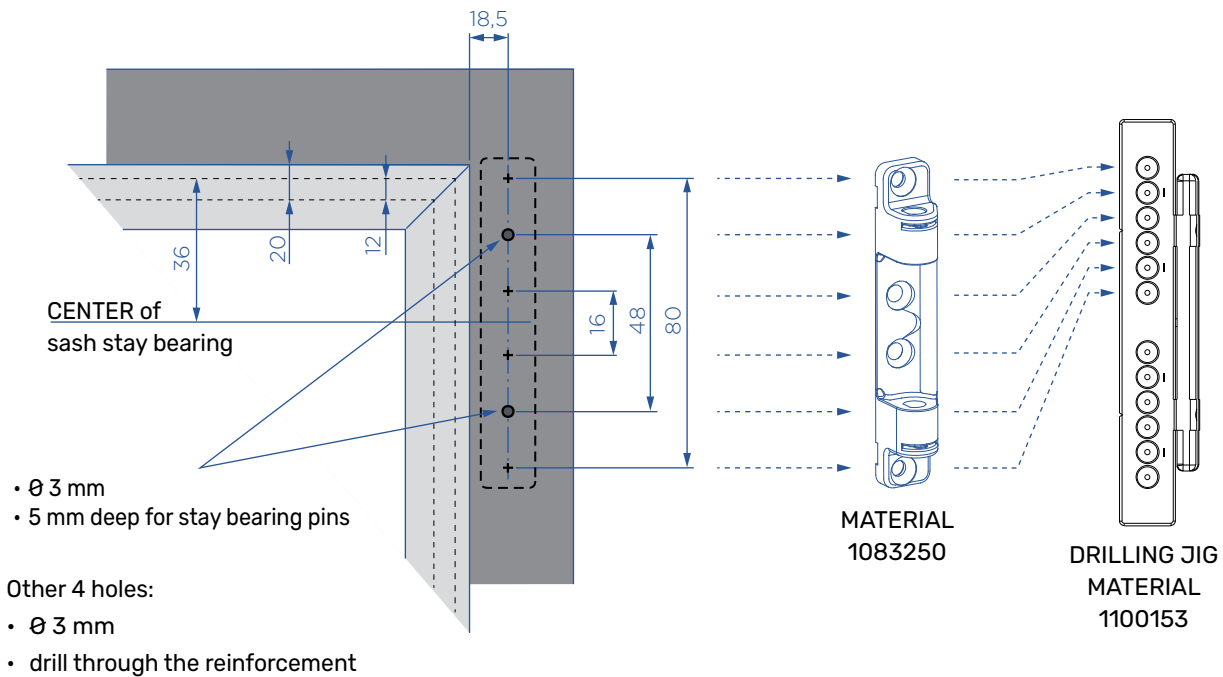

*WHEN USING A 20 mm HARDWARE OVERLAP, READJUST THE DRILLING JIG.

Corner pivot rest K3

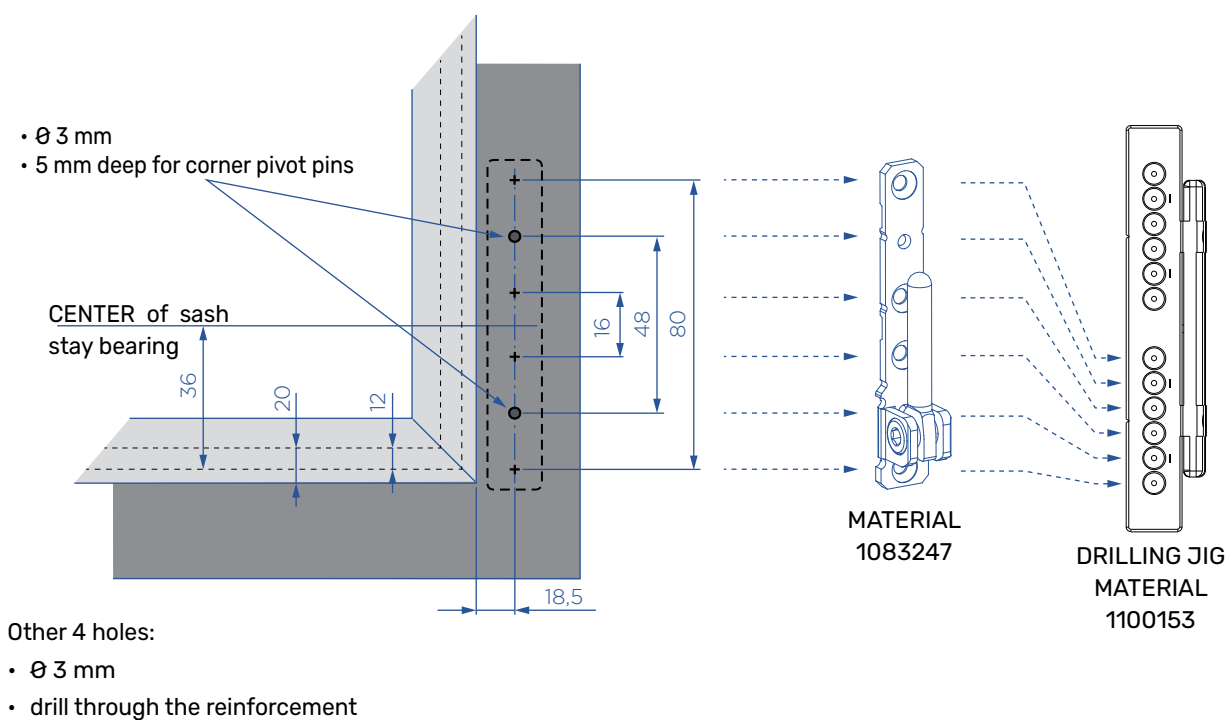

*WHEN USING A 20 mm HARDWARE OVERLAP, READJUST THE DRILLING JIG.

INSTALLATION INSTRUCTIONS

Sash stay guide and center lock assembly

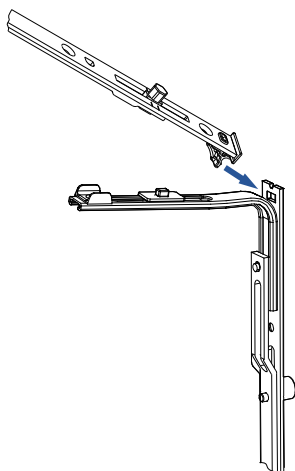

1.) Insert the connecting bracket into the hole of a centre lock

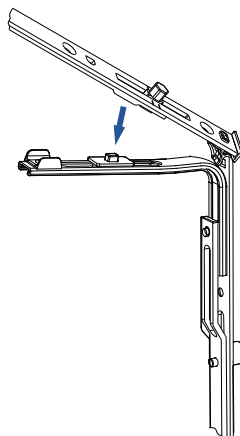

2.) Clamp the hole of a driving rod onto the stay guide connector

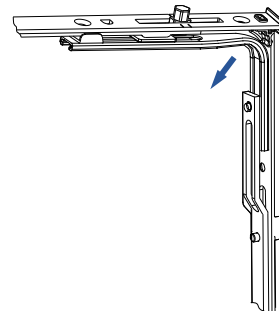

3.) Insert the assembly into a sash groove

Tilt lock bolt and center lock assembly

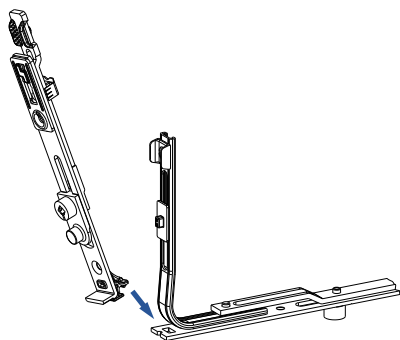

1.) Insert the connecting bracket into the hole of a centre lock

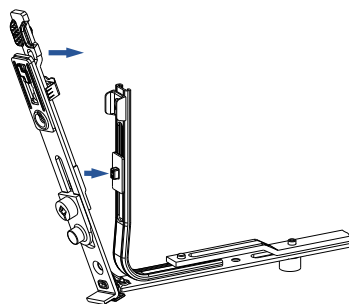

2.) Clamp the hole of a driving rod onto the tilt lock bolt connector

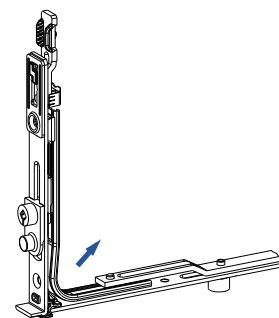

3.) Insert the assembly into a sash groove

T&T system with T&T espagnolette

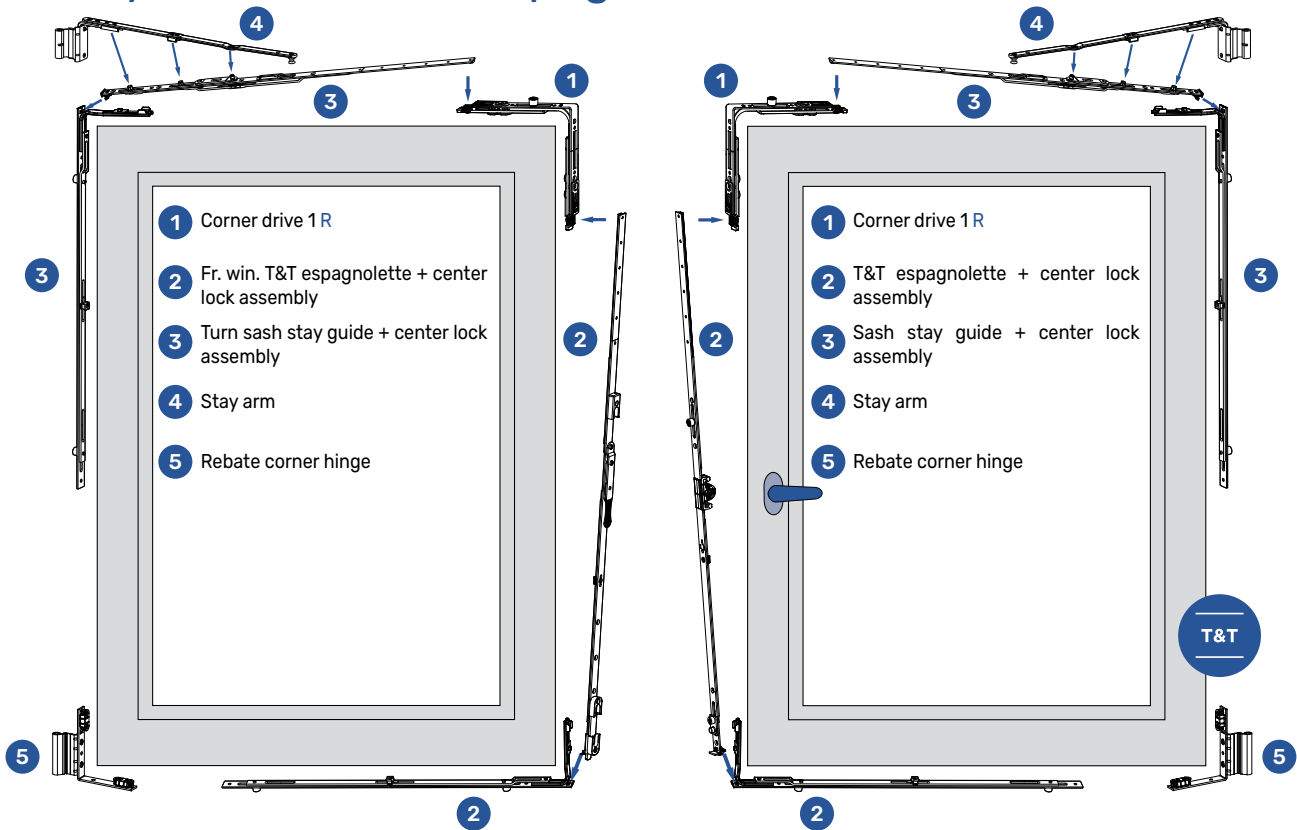

T&Ti system with T&T M espagnolette

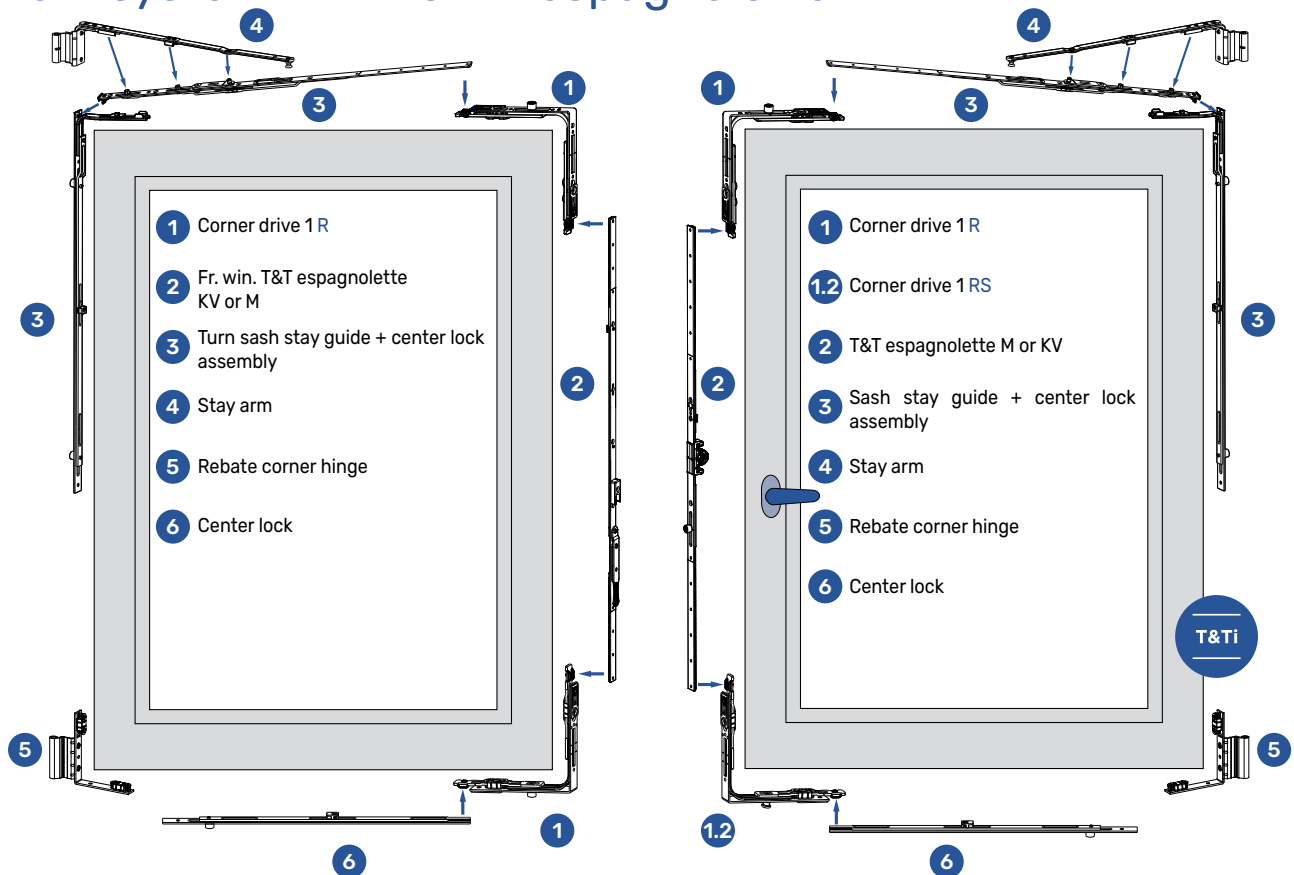

INSTALLATION INSTRUCTIONS

Slider

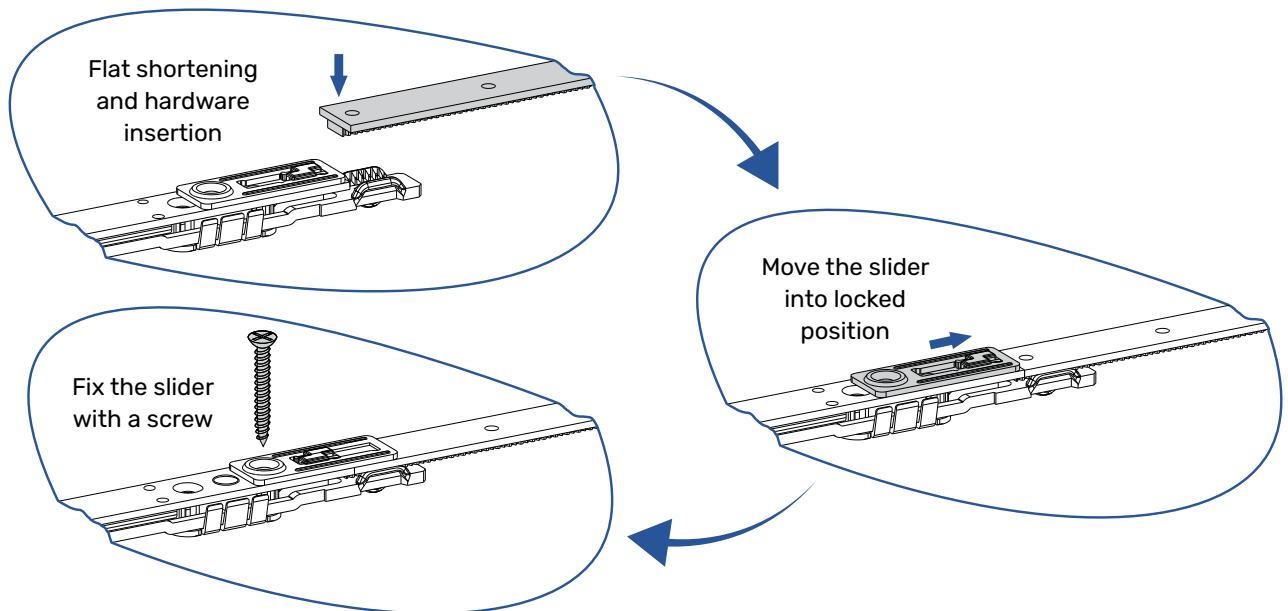

Anti slam device - tilt reduction

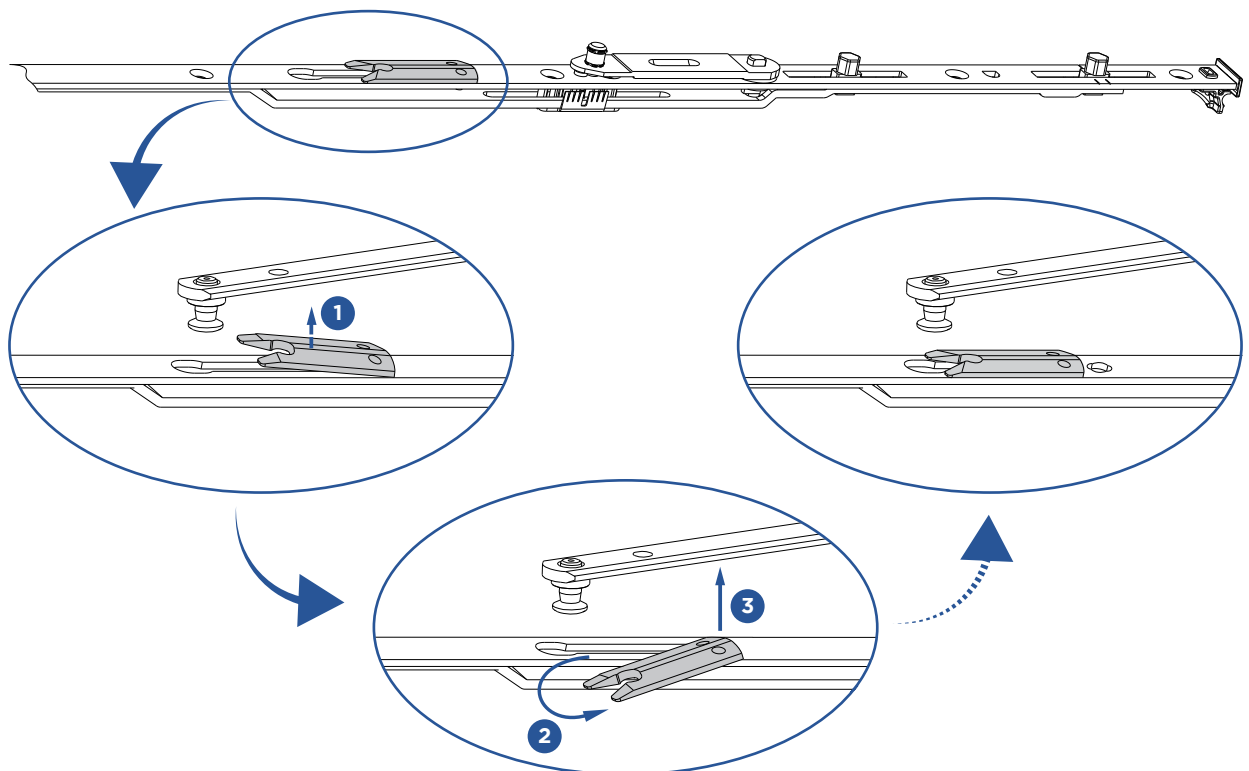

*PICTURES REPRESENT THE ADJUSTMENT OF THE ANTI-SLAM DEVICE (TILT REDUCEMENT)

*MOVE THE ANTI-SLAM DEVICE ON WINDOWS SRH < 500 mm, TO REDUCE TILT

STRIKER JIGS INSTALLATION INSTRUCTIONS

Types

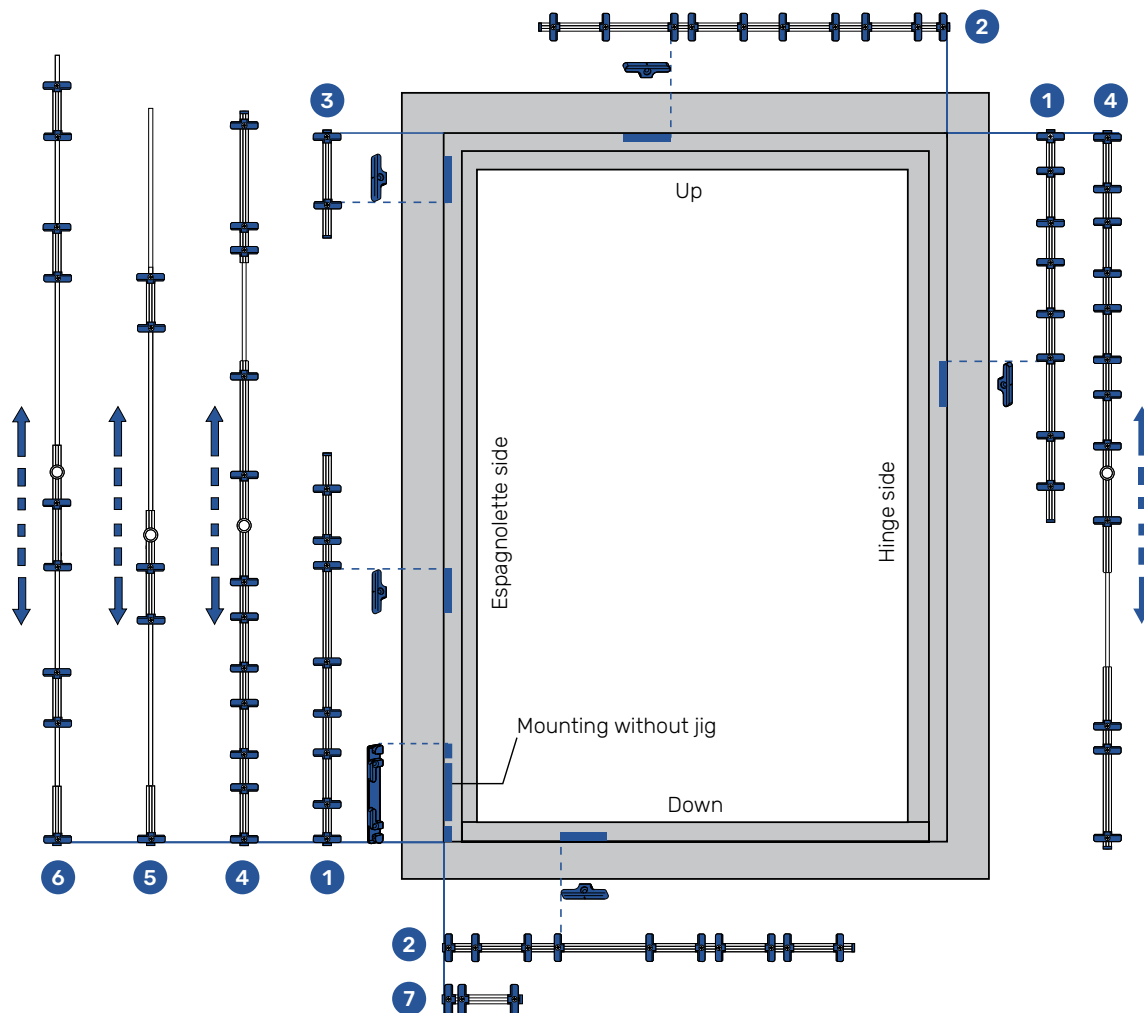

TYPE	DESCRIPTION	NOTE	MATERIAL
1	Constant handle height espag. / hinge side center lock	SRH < 1600	1103566
1a	TYPE 1 - with additional cam - telescopic jig	SRH < 1600	1103567
2	Center lock and sash stay guide up / center lock down	SRW < 1400	1103568
3	Corner drive	SRW < 1400	1103569
4	Constant handle height espag. - telescopic jig (door)	SRH > 1601	1103570
4a	TYPE 4 - with additional cam	SRH > 1601	1103571
5	Centered handle height espag. - telescopic jig (window)	SRH < 1600	1103572
5a	TYPE 5 - with additional cam	SRH < 1600	1103573
6	Centered handle height espag. - telescopic jig (door)	SRH > 1601	1103574
6a	TYPE 6 - with additional cam	SRH > 1601	1103575
7	T&Ti striker	SRW < 1400	1108014

STRIKER JIGS INSTALLATION INSTRUCTIONS

Instructions for use

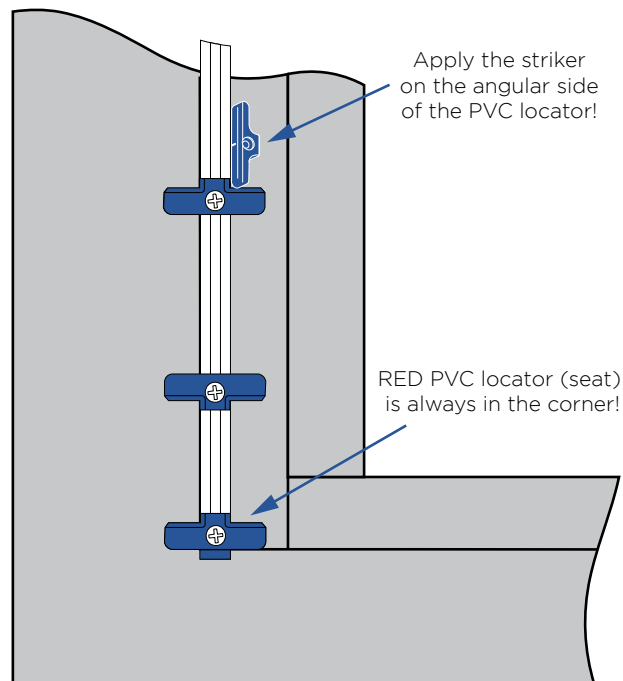
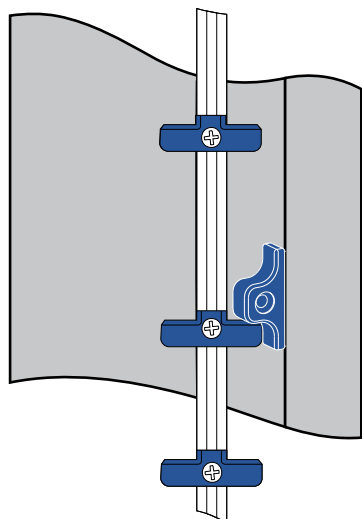

MSD scheme

CAM scheme

COLOR of PVC LOCATOR	DESCRIPTION	NOTES
RED	Seat - NO locking cam	No striker
YELLOW	Corner drive locking cam	Located next to the seat
YELLOW	Espagnolette locking cam	/
GREEN	Mishandling device - frame part	Montage shown on MSD scheme
BLUE	Sash stay guide locking cam	/
BROWN	Center lock locking cam	/

Face-fit hinge side

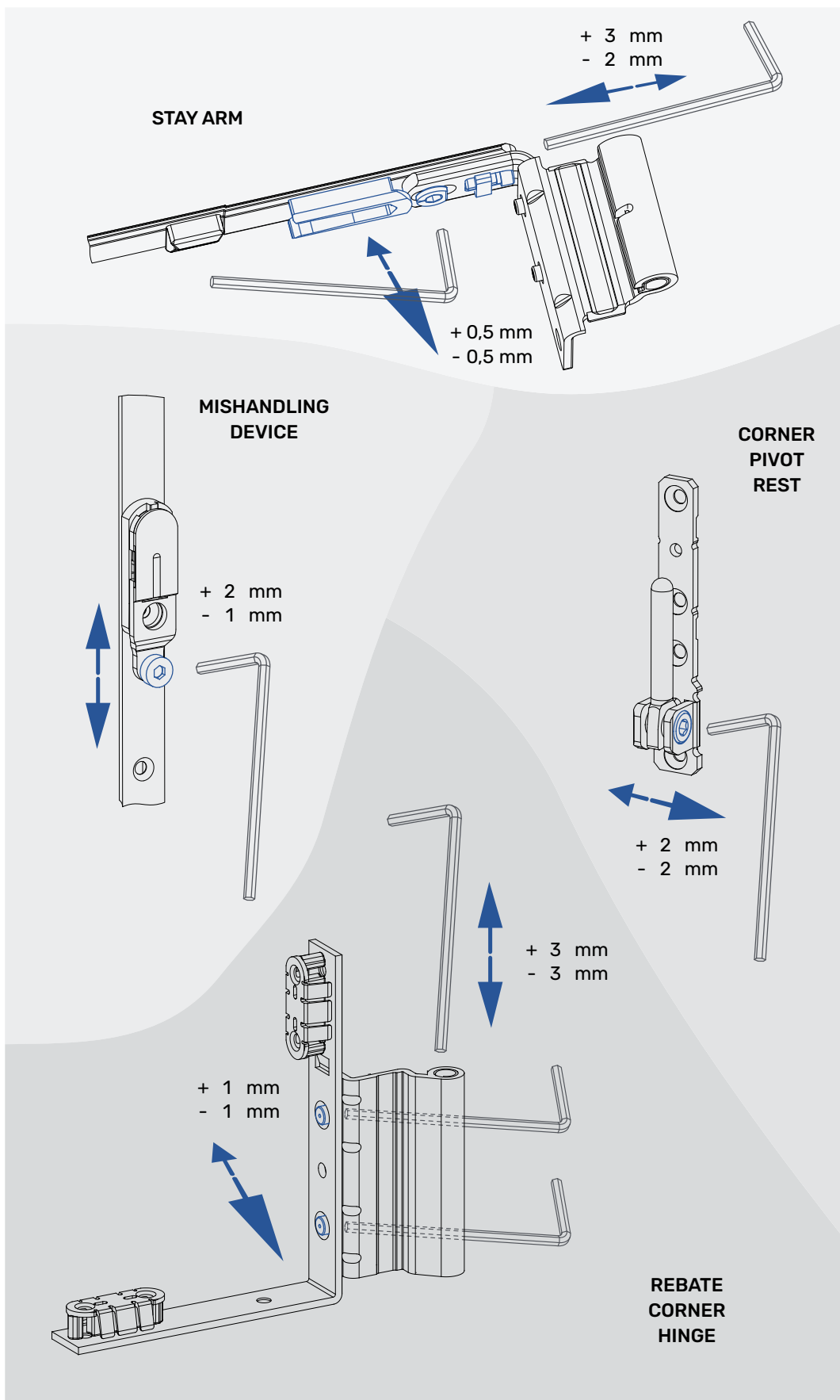

LOCKING CAM ADJUSTMENT INSTRUCTIONS

ROLLING CAM / R CAM

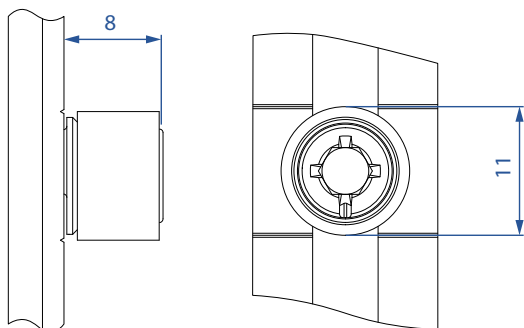
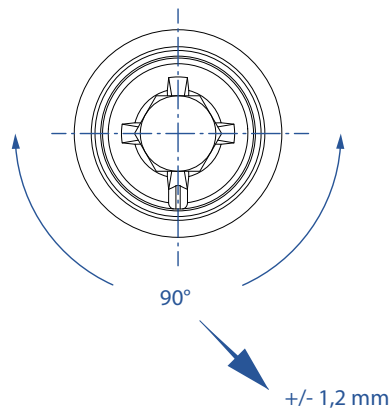

ROLLING SECURITY CAM / RS CAM

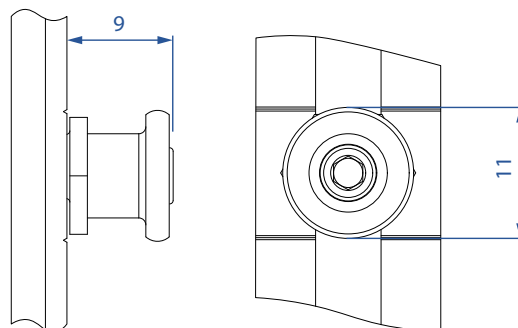
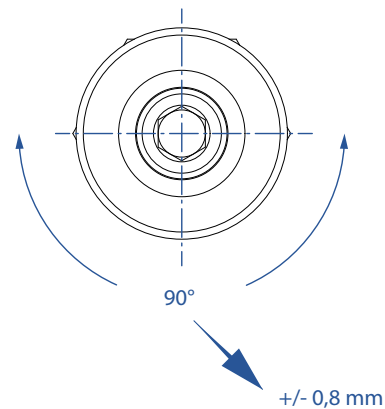

R CAM ADJUSTMENT TOOL

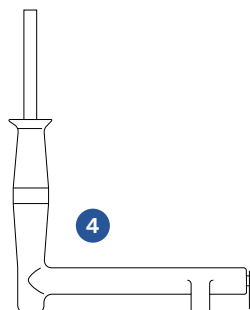
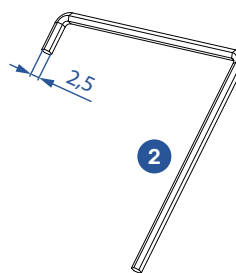
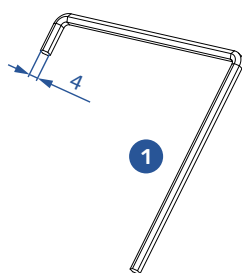

TYPE	DESCRIPTION	SIZE	MATERIAL
1	HEX KEY	4 mm	1095750
2	HEX KEY	2,5 mm	/
3	SPANNER	10 mm	/
4*	MOUNTING HANDLE	/	1134960

* FOR SASH STAY BEARING PIN MOUNTING

Operation of window

TURN & TILT - TURN FIRST

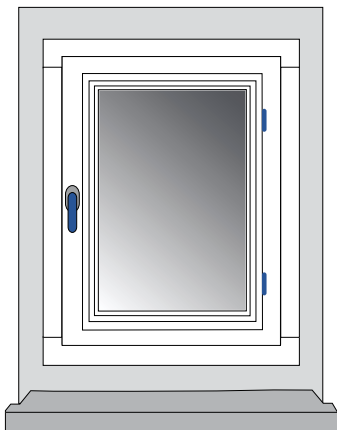

CLOSED POSITION

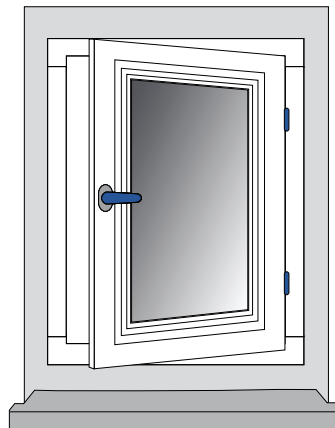

OPENED POSITION - TURN

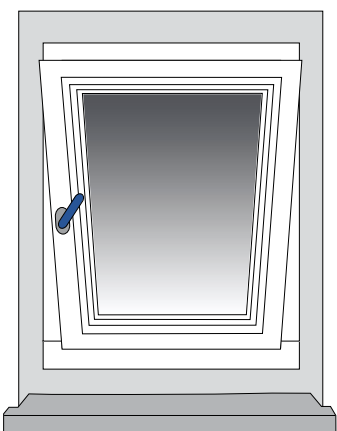
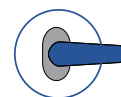

NIGHT VENT POSITION

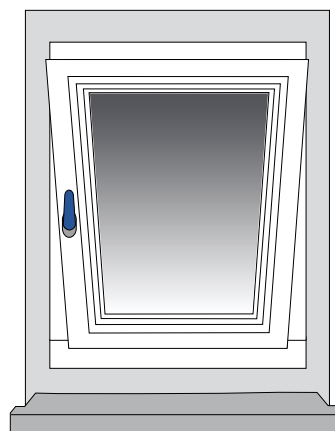

OPENED POSITION - TILT



OPERATING AND SYSTEM INSTRUCTIONS

Warning!

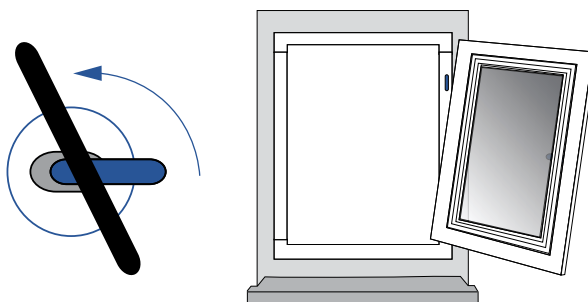

MALPOSITIONING OF THE SASH

IN ORDER TO PRESERVE THE LONG OPERATIVENESS OF YOUR WINDOW AND TO GUARANTEE SECURITY, IT IS IMPERATIVE TO OBSERVE THE DIRECTIVES LISTED BELOW.

DO NOT PLACE ANY OBJECTS BETWEEN THE SASH AND FRAME.

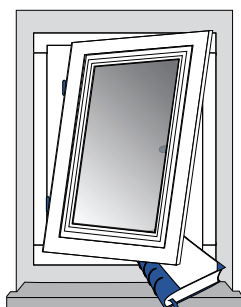

DO NOT ALLOW THE SASH TO HIT OR PRESS UP AGAINST THE WINDOW REVEAL.

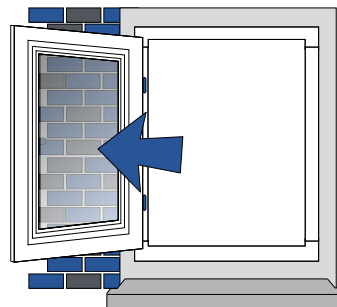

THE WINDOW SASH MAY NOT BE BURDENED WITH ADDITIONAL WEIGHT.

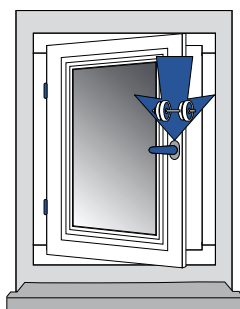

CAUTION!
WHERE SMALL CHILDREN OR MENTALLY HADICAPPED PERSONS HAVE ACCESS TO THE WINDOW, THE SASH HAS TO BE SAFEGUARDED AGAINST TURNING, FOR EXAMPLE WITH A CHILD-SAFETY LOCK OR KEY-LOCKABLE HANDLES.

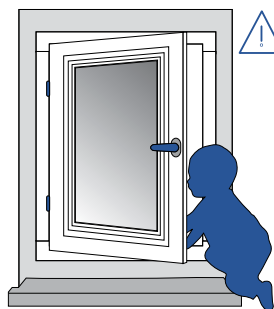

DO NOT LEAVE SASHES OPEN IN THE TURN POSITION DURING STRONG WINDS.

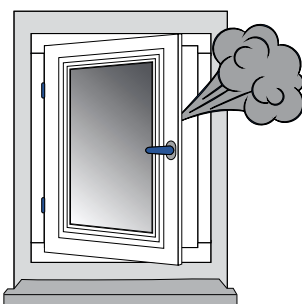

CAUTION!
A SLAMMING SASH CAN LEAD TO INJURIES. WHILE CLOSING, DO NOT GRASP BETWEEN THE SASH AND FRAME.

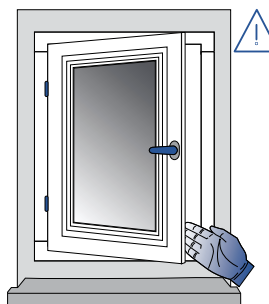

MAINTENANCE RECOMMENDATIONS

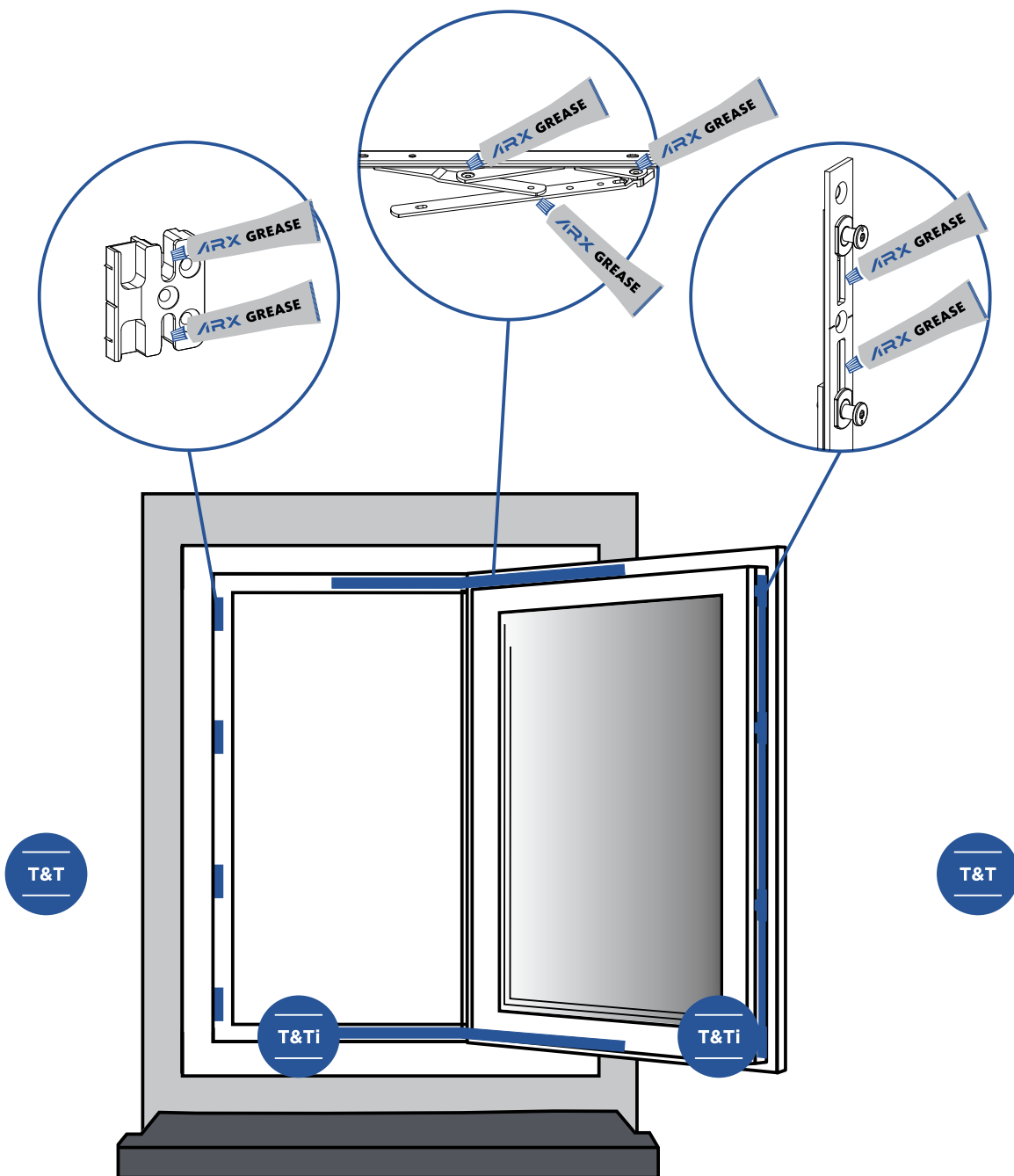

Regular greasing and oiling of operation-relevant components in the sash and frame is recommended at least once a year. In case of frequent use as in schools, hotels the oiling is recommended once in six months.

Acid free and non-resinous grease and/or oil from a specialized dealer must be used.



DESCRIPTION	MATERIAL
ARX - HIGH QUALITY HARDWARE GREASE	1055144

ARX
The Hardware.



ARX handles

Handles for windows
Detailed information

HANDLES

The program of ARX Handles for windows is divided into three sections:

- Standard,
- Secustic – safety handle system: this program is distinguished by higher anti-burglary safety,
- Secustic with a lock: additional security against unauthorized opening of windows.

ARX Handles for windows are suitable for installation into different thickness of the profiles. Accordingly, three spindle sizes are used:

- 32 mm,
- 37 mm,
- 42 mm.

With ARX Handles set for balcony doors, a uniform appearance of the building hardware will be provided:

- set handle / handle,
- set handle / handle for balcony door with roller shutters.

Set for balcony doors are used for profile thickness of 68-78 mm. For thicker profiles, it's necessary to use longer screws for fixing the handles.

Certificate of Quality



ARX handles are made of quality material (aluminium) and protected by persistent surface protection of powder coating in different colors. Quality materials, modern manufacturing processes and product testing have led ARX handles to have a long lifetime and a 10 year warranty.



ARX handles have a quality certificate, the German Quality Assurance Institute. We are convinced that our products and services will continue to be a good guarantee for our future long-standing partnership and we look forward to further cooperation with you.

HANDLES

Window handles

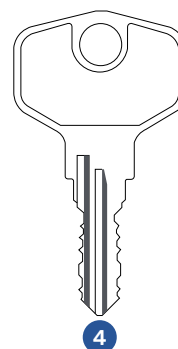
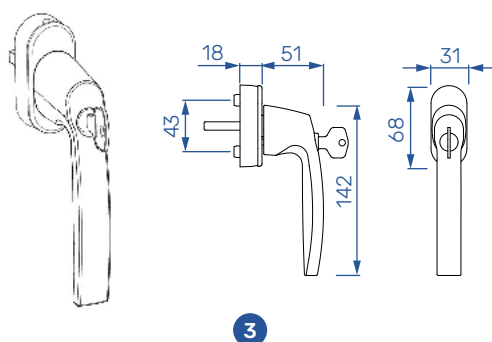
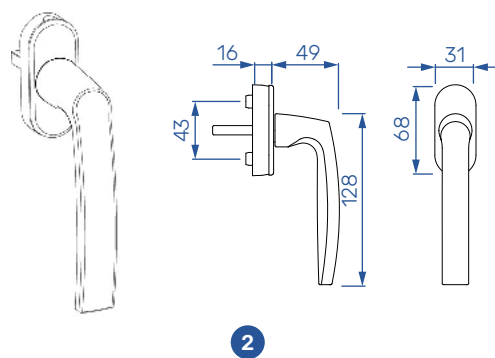
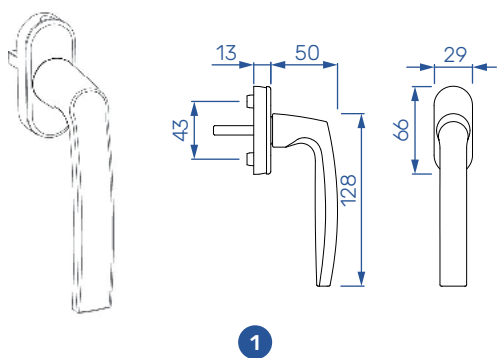

TYPE	DESCRIPTION	L	COLOR	PACK	MATERIAL
1	STANDARD HANDLE	32	F4 - dark bronze	20	1053207
		37	F1 - silver	20	1053212
		37	F4 - dark bronze	20	1053213
		37	F9 - titan	20	1053214
		37	RAL 9010 - white	20	1053215
		37	RAL 8707 - brown	20	1053216
		42	F1 - silver	20	1100839
		42	RAL 9010 - white	20	1058068
		42	RAL 8707 - brown	20	1058069
2	SECUSTIC HANDLE	37	F1 - silver	10	1053222
		37	F4 - dark bronze	10	1053223
		37	F9 - titan	10	1053224
		37	RAL 9010 - white	10	1053225
		37	RAL 8707 - brown	10	1053226
3	SECUSTIC HANDLE WITH SAFETY LOCK	37	F1 - silver	10	1053232
		37	F4 - dark bronze	10	1053235
		37	F9 - titan	10	1053236
		37	RAL 9010 - white	10	1053237
4	SPARE KEY FOR HANDLE	37	RAL 8707 - brown	10	1053238
		/	/	1	1119964

Balcony door handles

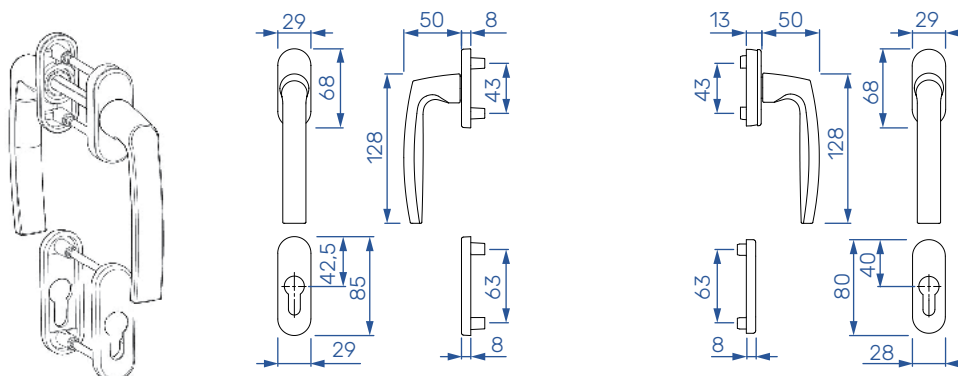

1

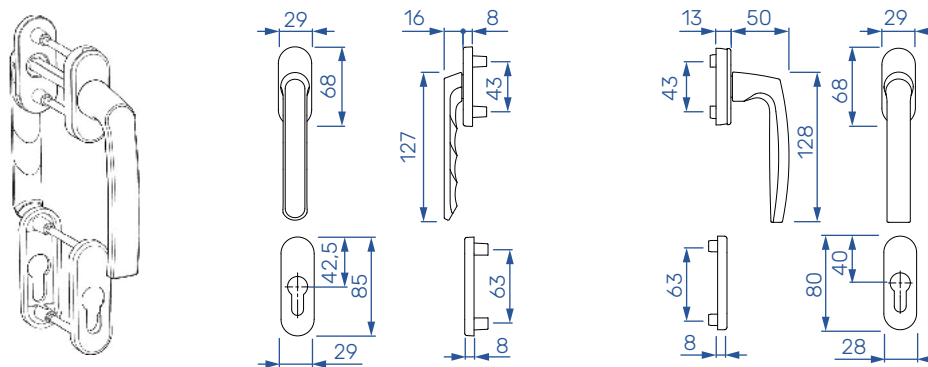

2



TYPE	DESCRIPTION	COLOR	PACK	MATERIAL
1	BALCONY DOOR HANDLE	F1 - silver	10	1053267
		F4 - dark bronze	10	1053268
		F9 - titan	10	1053269
		RAL 9010 - white	10	1053270
2	BALCONY DOOR HANDLE - ROLLER SHUTTERS	F1 - silver	10	1053281
		F4 - dark bronze	10	1053282
		F9 - titan	10	1053283
		RAL 9010 - white	10	1053284

HANDLES

Balcony door handles - basic

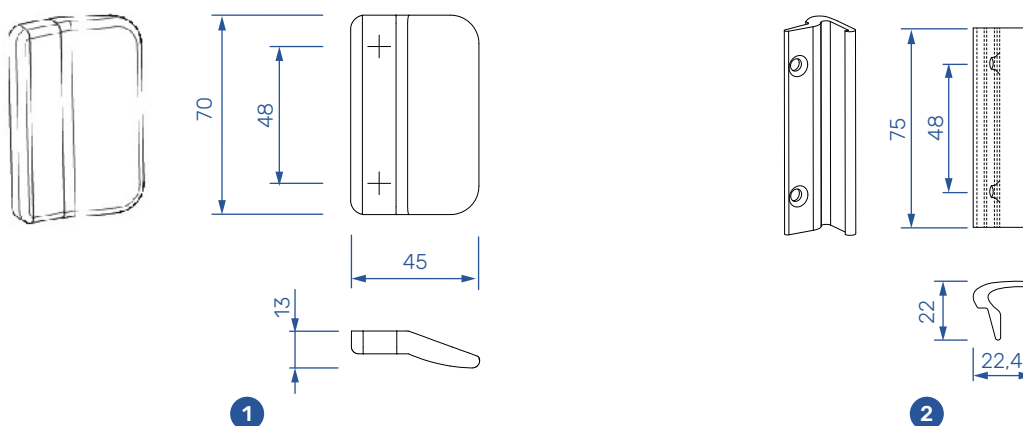

TYPE	DESCRIPTION	COLOR	PACK	MATERIAL
1	PVC material	RAL 8016 - brown	1	1053291
		RAL 9016 - white	1	1120683
		RAL 7016 - anthracite grey	1	1120684
2	ALU material	RAL 8019 - grey brown	1	1118689
		RAL 9016 - white	1	1117164
		RAL 7016 - anthracite grey	1	1117165

Rosette



TYPE	DESCRIPTION	COLOR	PACK	MATERIAL
1	FOR REMOVABLE HANDLE - PVC material	RAL 9016 - white	1	1053292
2	OVAL ROSETTE - ZAMAK material	RAL 8019 - grey brown	1	1081621
		RAL 9016 - white	1	1085631



Kovinoplastika Lož d.o.o.
Cesta 19. oktobra 57, Lož
1386 Stari trg pri Ložu
Slovenia

Follow us:

